



GUIDE FOR THE ASSESSMENT OF

# Cacao Quality and Flavour



**mocca**

Maximizing Opportunities  
in Coffee and Cacao in the Americas



**Citation:** Cacao of Excellence. 2023. Guide for the Assessment of Cacao Quality and Flavour. Compiled by the Cacao of Excellence programme of the Alliance of Bioversity International and CIAT, in collaboration with the members of the Working Group on the development of the International Standards for the Assessment of Cocoa Quality and Flavour (ISCQF). Bioversity International. 216 Pages.

ISBN 978-92-9255-295-4 Print Issue

ISBN 978-92-9255-296-1 Digital Issue

Compilers and Editors

**Brigitte Laliberté, Dolores Alvarado, Nadia Villaseñor (Bioversity International) and Sara Fusi (RB-ELLI )**

Creative director, layout, and design

**Daniel Gutiérrez (Alliance of Bioversity International and CIAT, Communications Unit)**

Cover photo

**CIAT/Neil Palmer**

Copyright: Bioversity International 2023. Some rights reserved.

This work is licensed under a Creative Commons Attribution NonCommercial 4.0 International License (CC-BY-NC)

<https://creativecommons.org/licenses/by-nc/4.0/>

September 2023



GUIDE FOR THE ASSESSMENT OF

# Cacao Quality and Flavour

**mocca** | Maximizing Opportunities  
in Coffee and Cacao in the Americas







**Empowering  
a new generation  
of cacao producers  
of excellence**

# Foreword

The global cacao market has witnessed remarkable growth and diversification in recent years, with increasing demand for superior quality cacao. However, the cacao sector has long faced significant challenges due to the absence of agreed-upon standards for assessing cacao quality and a lack of a common language to describe cacao flavour diversity. These deficiencies hinder effective communication between producers and buyers, particularly impacting farmers in developing countries striving to sell superior quality cacao deserving of premium prices. To address these issues and meet evolving consumer needs, it's crucial to establish credible, reliable and standardised methods for assessing cacao quality and flavour.

The Guide includes detailed protocols and procedures for evaluating cacao in various forms, such as unroasted cacao bean coarse powder, cacao mass, and chocolate. These methodologies have been developed over several years by a diverse group of experts, enabling objective assessments of cacao quality and flavour. It provides a universal language for describing cacao attributes, for a shared understanding among cacao professionals worldwide. This Guide serves as a comprehensive resource for individuals, associations and organisations interested in internationally aligned capacity building, with the objective of setting up cacao quality and flavour assessment facilities and sensory evaluation panels.

The development of this Guide has been a collective endeavour spanning several years, drawing upon the expertise of stakeholders across the cacao sector. It began in September 2015 with the formation of an informal working group, coordinated by Cacao of Excellence to explore the establishment of international standards for assessing cacao quality and flavour. The group conducted a comprehensive review of existing standards in cacao, coffee, olive oil and wine. In 2016, a first proposal for a harmonised standard for cocoa quality and flavour assessment was developed, led by Dr Darin Sukha of the Cocoa Research Centre at the University of the West Indies in Trinidad and Tobago (CRC). In 2017 and 2018, individual protocols were developed based on this proposal and reviewed extensively by members of the working group and diverse stakeholders from the cacao sector. Between 2018 to 2022, a meticulous external review and refinement process involved more than 100 people from over 30 countries, resulting in this Guide. By 30 June 2023, more than 1,500 people from 105 countries had downloaded the protocols.

This Guide captures critical cacao bean processing adjustments and innovations developed over each Cacao of Excellence Award edition since 2009 by Ed Seguire of Seguire Cacao Cocoa and Chocolate Advisors and Guittard Chocolate, Chair of the Technical Committee, and its members.

Producers, buyers, traders, manufacturers, researchers, and development experts from the public and private sectors contributed their knowledge and experience to ensure the relevance and applicability of these protocols. Their collective input has made this Guide a valuable reference manual for all stakeholders in the cacao value chain.

These protocols are implemented in a several of countries and organisations, paving the way for global utilisation. We envision this Guide becoming the go-to resource for quality and flavour assessments, training programmes, and the establishment of national standards for cacao quality and flavour, complete with laboratories and sensory evaluation panels. This guide aims to empowering producers to better understand the quality of their cacao and connect with higher-value markets and receive objective feedback for improving pre- and post-harvest processes.

We extend our deepest gratitude to all the individuals and organisations who have dedicated their time and expertise to bring this Guide to fruition. We hope that its widespread adoption will elevate the entire cacao sector, enhance the understanding of cacao's unique attributes, and ultimately ensure that producers of exceptional cacao receive the recognition they deserve, leading to increased value and income for sustainable livelihoods. This, in turn, will enable consumers around the world to savour the finest and most distinctive cacao products.

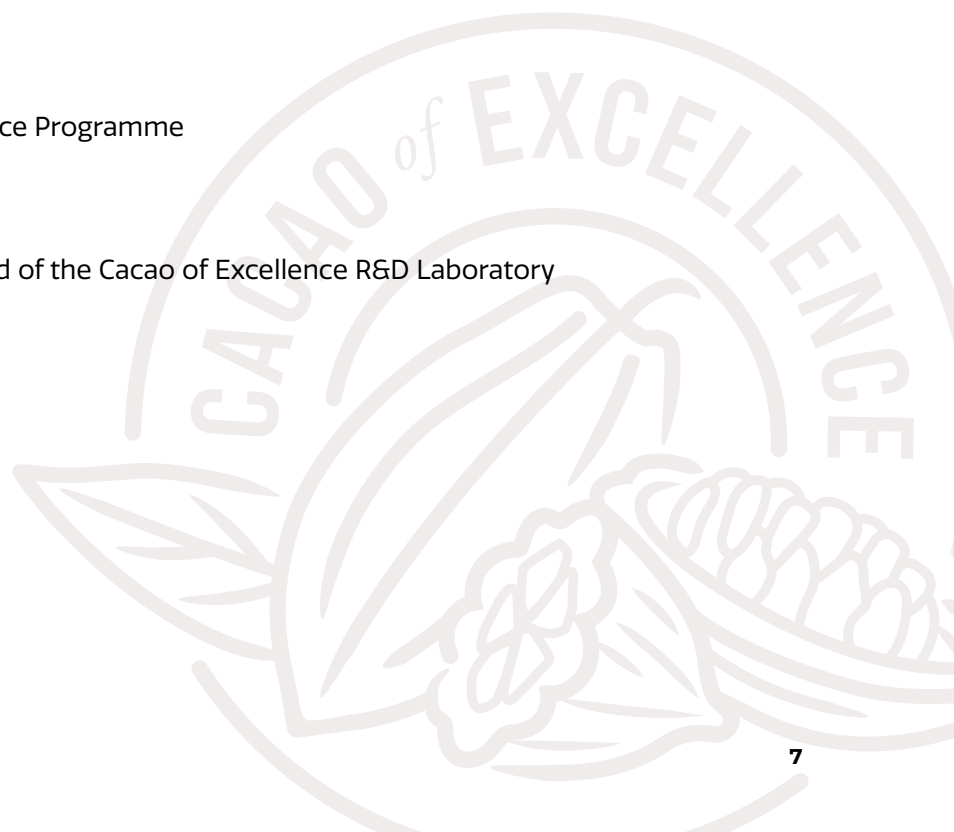
Together, let us continue to cultivate excellence in cacao quality and flavour assessment.

**Brigitte Laliberté**

Strategic Advisor, Cacao of Excellence Programme

**Dolores Alvarado**

Food Technologist and Interim Head of the Cacao of Excellence R&D Laboratory



# Disclaimer

The protocols on cacao bean physical evaluation, sample processing and sensory evaluation of cacao mass and chocolate were developed over several years by Ed Seguine of Seguine Cacao Cocoa and Chocolate Advisors, and Guittard Chocolate. Darin Sukha from the Cocoa Research Centre of the University of the West Indies (CRC) and Edward Seguine co-developed the protocol for sensory evaluation of cacao mass and chocolate. These protocols have been implemented by the Cacao of Excellence programme since 2009.

The content of the protocol on Sensory evaluation of cacao beans as coarse powder (Section 17) were developed by the Fine Cacao and Chocolate Institute (FCCI) and reviewed by the members of the ISCQF Working Group.

Since 2017, the elaboration of all protocols have been the results of close collaboration with a diverse range of stakeholders and sensory evaluation experts. First public drafts of nine protocols were published between 2019–2021, as part of the International Standards for the Assessment of Cocoa Quality and Flavour (ISCQF) and reviewed by the members of the Working Group on the ISCQF.

During the development of this guide, the initial public drafts received extensive feedback from numerous reviewers representing various organisations and countries. A comprehensive public consultation period took place between 2019–2022 to gather input and opinions. All comments received were carefully evaluated and incorporated into the final version where relevant. Conflicting views were addressed through discussions with experts in the field.

The Guide includes suggestions of brands and models for informational purposes only, without any commercial intent. It is important to exercise caution and follow appropriate safety measures while using any tools and equipment mentioned. Users are advised to consult the specific operating manuals for each item for detailed instructions.

# Acknowledgements

We would like to express our gratitude to the members of the Working Group on the International Standards for the Assessment of Cocoa Quality and Flavour (ISCQF), coordinated by the Alliance of Bioversity International and CIAT, as well as Cacao of Excellence for their guidance and support in developing this document. The compilation of protocols presented in this guide is the result of extensive consultations and numerous inputs from experts, as well as broad public review.

Special acknowledgment goes to Ed Seguine, of Seguine Cacao Cocoa and Chocolate Advisors, Chair of the Cacao of Excellence Technical Committee, and consultant to Guittard Chocolate for his significant contributions to the cacao sector and the protocols and procedures of Cacao of Excellence since its inception in 2009, forming the backbone of this Guide. Additionally, we extend our appreciation and gratitude to Dr Darin Sukha from the Cocoa Research Centre of the University of the West Indies (CRC) for conducting an initial comprehensive review of existing standards in cacao and other commodities such as coffee, olive oil, and wine. Dr Sukha's work resulted in the development of the first proposal entitled 'Elements of a harmonized international standard for cocoa quality and flavour assessment' in 2016.

We extend our sincere appreciation to the following organisations for their financial support:

- The Cacao of Excellence programme of the Alliance of Bioversity International and CIAT and all its partners, sponsors and contributors since its establishment in 2009.
- MOCCA project (Maximizing Opportunities in Coffee and Cacao in the Americas), funded by the United States Department of Agriculture (USDA) and implemented by a consortium led by TechnoServe, with cacao activities led by Corus International's Lutheran World Relief (LWR) and components on cacao research and quality standards led by Cacao of Excellence of the Alliance of Bioversity International and CIAT, from April 2019 to June 2023.
- Pennsylvania State University (Penn State) Research and Scientific Exchange Programme to Support the Development of Fine Flavor Cacao in Latin America and the Caribbean (LAC), funded by USDA and implemented from July 2018 to May 2019.
- MOCA project (Maximizing Opportunities for Cacao Activity), funded by USDA and implemented by Cultivating New Frontiers in Agriculture (CNFA), for their assistance in providing French translations of a selection of first draft protocols in 2020.
- European Cocoa Association (ECA), the Association of Chocolate, Biscuit and Confectionery Industries of Europe (CAOBISCO), and the Federation of Cocoa Commerce London (FCC) for their financial support to the Cacao of Excellence Programme in 2016–2017, contributing to this process.

We acknowledge with gratitude the following organisations participating in the Working Group on the ISCQF for their valuable in-kind contributions:

- Alliance of Bioversity International and CIAT and its Cacao of Excellence programme.
- Asociación Mesoamericana del Cacao y Chocolates Finos (AMACACAO).
- Barry Callebaut.
- Centre for the Promotion of Imports from developing countries (CBI).
- Cocoa Research Centre of the University of the West Indies (CRC).
- ECOM Trading.
- Fine Cacao and Chocolate Institute (FCCI).
- Fine Chocolate Industry Association (FCIA).
- Guittard Chocolate Company.
- International Cocoa Organization (ICCO).
- International Institute of Chocolate & Cacao Tasting (IICCT).
- Lutheran World Relief (LWR).
- Puratos/Belcolade.
- Seguire Cacao Cocoa and Chocolate Advisors.
- TCHO Chocolate.
- Universidad Nacional Agraria La Molina (UNALM).
- USAID–Equal Exchange–TCHO Cooperative Development Programme.
- Valrhona Chocolate.
- World Cocoa Foundation (WCF).

We would like to acknowledge the following organisations for their financial support during consultancies and consultation meetings between 2017–2020:

- Alliance of Bioversity International and CIAT and its Cacao of Excellence programme.
- Asociación Mesoamericana de Cacao y Chocolates Finos (AMACACAO).
- Catholic Relief Services.
- CGIAR Research Programme on Forest, Trees and Agroforestry.
- Christian Aid.
- Corus International's Lutheran World Relief and its project Cacao Móvil, supported by the United States Department of State and the Swiss Agency for Development and Cooperation.
- Event International and Salon du Chocolat.
- Penn State USDA-funded project.

We also acknowledge the following individuals who provided invaluable support in proofreading and editing the English, Spanish, and French versions of the first public draft protocols: Dolores Alvarado, Brigitte Laliberté, Olga Spellman, Silvia Araujo de Lima, from the Alliance of Bioversity International and CIAT, and Pierre Costet of Valrhona Chocolate.

This Guide was English copy-edited by Nadia Villaseñor, Communications Specialist of the Cacao of Excellence Programme, and Sara Fusi of RB-ELLI. The content was translated into Spanish by Karen Amaya Vecht, a consultant to the Alliance of Bioversity International and CIAT.

The design and layout were conducted by Daniel Gutiérrez, Senior Graphic Designer of the Communication team of the Alliance of Bioversity International and CIAT. The graphic design elements were translated in Spanish by Lorena García, consultant to the Alliance of Bioversity International and CIAT.

Finally, we extend our thanks to the many contributors who participated in the consultation process and provided valuable inputs to the protocols (for a full list of contributors, see the section entitled 'Contributors').

# About the Alliance of Bioversity International and CIAT

The Alliance of Bioversity International and the International Center for Tropical Agriculture (CIAT) delivers research-based solutions that address the global crises of malnutrition, climate change, biodiversity loss, and environmental degradation. The Alliance focuses on the nexus of agriculture, nutrition, and environment. We work with local, national, and multinational partners across Africa, Asia, and Latin America and the Caribbean, and with the public and private sectors and civil society. With novel partnerships, the Alliance generates evidence and mainstreams innovations to transform food systems and landscapes so that they sustain the planet, drive prosperity, and nourish people in a climate crisis. The Alliance is part of CGIAR, a global research partnership for a food-secure future dedicated to transforming food, land, and water systems in a climate crisis.

[alliancebioversityciat.org](http://alliancebioversityciat.org)

[cgiar.org](http://cgiar.org)

## About Cacao of Excellence

Cacao of Excellence, led by the CGIAR's Alliance of Bioversity International and the International Center for Tropical Agriculture (CIAT), is a unique global platform that discovers, convenes, promotes, and rewards cacao producers of excellence from all origins, focusing on superior cacao quality and flavour diversity. Since 2009, the platform has held the prestigious global Cacao of Excellence Awards, celebrating the work of cacao producers and showcasing exceptional flavours worldwide. Cacao of Excellence's vision is to drive the expansion of superior quality cacao, ensuring more producers thrive and benefiting resilient agricultural systems. By recognising, preserving, and valuing cacao quality and flavour diversity across the value chain, Cacao of Excellence improves smallholder farmers' livelihoods and drives sustainability in the cacao supply chain, fostering thriving, resilient, and healthy communities, from origins to consumers. Its five strategic pillars are: (1) Global Co-elevating Cocoa Origins through the Awards, (2) Data-driven Innovations Developed and Adopted, (3) Safeguard of Cocoa Genetic Diversity, (4) Develop Capacity to Adopt Innovations that Generate Value and (5) A Community for Excellence.

[cacaoofoxcellence.org](http://cacaoofoxcellence.org)

# About MOCCA

MOCCA (Maximizing Opportunities in Coffee and Cacao in the Americas) is a consortium led by Technoserve, Lutheran World Relief and World Coffee Research, with implementing partners like the Alliance Bioveristy-CIAT facilitating a series of benefits for coffee and cacao producers including: the opportunity to integrate higher value commercial models, technical assistance, access to higher quality planting material, access to research results, and the opportunity to participate in catalytic financing models. MOCCA is primarily funded by the US Department of Agriculture through their Food for Progress Program, which seeks to expand agricultural productivity and trade. Additional MOCCA co-funders include: The J.M. Smucker Company, JDE, Peets, Keurig-Dr. Pepper, Nespresso, Olam, and the Kellogg's Company.

[mocca.org](http://mocca.org)

# About USDA

The United States Department of Agriculture (USDA) is the federal executive department responsible for developing and executing federal laws related to farming, forestry, rural economic development, and food. It aims to meet the needs of commercial farming and livestock food production, promotes agricultural trade and production, works to assure food safety, protects natural resources, fosters rural communities and works to end hunger in the United States and internationally.

[usda.gov](http://usda.gov)

## Acronyms

<b>Acronym</b>	<b>Meaning</b>
<b>AFCC</b>	Association Française du Commerce des Cacaos
<b>AMACACAO</b>	Asociación Mesoamericana del Cacao y Chocolates Finos
<b>AMAF</b>	ASEAN Ministers on Agriculture and Forestry
<b>APC</b>	Aerobic Plate Count
<b>ASEAN Stan</b>	Association of Southeast Asian Nations Standards
<b>ASTM</b>	ASTM International (formerly American Society for Testing and Materials)
<b>C-PET</b>	Crystalline Polyethylene Terephthalate
<b>CAOBISCO</b>	Association of Chocolate, Biscuit and Confectionery Industries of Europe
<b>CATIE</b>	Centro Agronómico Tropical de Investigación y Enseñanza
<b>CBI</b>	Centre for the Promotion of Imports from developing countries
<b>CCP</b>	Critical Control Point
<b>CDP</b>	Cooperative Development Program (USAID – Equal Exchange – TCHO Cooperative Development Programme)
<b>CIAT</b>	International Center for Tropical Agriculture
<b>CMAA</b>	Cocoa Merchants' Association of America
<b>CNFA</b>	Cultivating New Frontiers in Agriculture
<b>CoEx</b>	Cacao of Excellence Programme
<b>CRC</b>	Cocoa Research Centre of the University of the West Indies
<b>CRIG</b>	Cocoa Research Institute of Ghana
<b>ECA</b>	European Cocoa Association
<b>FAO</b>	Food and Agriculture Organization of the United Nations
<b>FCC</b>	Federation of Cocoa Commerce
<b>FCCI</b>	Fine Cacao and Chocolate Institute
<b>FCIA</b>	Fine Chocolate Industry Association



<b>Acronym</b>	<b>Meaning</b>
----------------	----------------

<b>FDA</b>	Food and Drug Administration
<b>HACCP</b>	Hazard Analysis and Critical Control Points
<b>ICCO</b>	International Cocoa Organization
<b>IICCT</b>	International Institute of Chocolate and Cacao Tasting
<b>ISCQF</b>	International Standards for the Assessment of Cocoa Quality and Flavour
<b>ISO</b>	International Organization for Standardization
<b>LAC</b>	Latin America and the Caribbean
<b>LWR</b>	Lutheran World Relief
<b>MOCA</b>	Maximizing Opportunities for Cocoa Activity
<b>MOCCA</b>	Maximising Opportunities in Coffee and Cacao in the Americas
<b>RH</b>	Relative Humidity
<b>SD</b>	Standard Deviation
<b>SPC</b>	Standard Plate Count
<b>TPC</b>	Total Plate Count
<b>UNALM</b>	Universidad Nacional Agraria La Molina
<b>UNCTAD</b>	United Nations Conference on Trade and Development
<b>USAID</b>	United States Agency for International Development
<b>USDA</b>	United States Department of Agriculture
<b>ZHAW</b>	Zürich Hochschule für Angewandte Wissenschaften (Zürich University for Applied Sciences)
<b>WCF</b>	World Cocoa Foundation
<b>WHO</b>	World Health Organization
<b>WTO</b>	World Trade Organization

# Table of Contents

**6 Foreword**

**8 Disclaimer**

**9 Acknowledgements**

**12 About the Alliance of Bioversity International and CIAT**

**12 About Cacao of Excellence**

**13 About MOCCA**

**13 About USDA**

**14 Acronyms**

**18 General introduction**

## **23 Part A: General considerations**

- 23 Chapter 1. Introduction
- 24 Chapter 2. Key parameters and specifications
- 25 Chapter 3. Food safety considerations
- 31 Chapter 4. Storage and ageing of cacao products
- 33 Chapter 5. Sampling bagged and bulk cacao beans

## **45 Part B: Physical evaluation**

- 45 Chapter 6. Introduction
- 46 Chapter 7. Determination of moisture content
- 51 Chapter 8. Physical evaluation of whole cacao beans
- 56 Chapter 9. Physical evaluation of cut cacao beans

## **63 Part C: Processing cacao bean samples**

- 63 Chapter 10. Introduction
- 64 Chapter 11. Roasting cacao beans
- 71 Chapter 12. Breaking and winnowing cacao beans
- 77 Chapter 13. Processing cacao nibs into mass
- 83 Chapter 14. Processing cacao mass into dark chocolate

## **93 Part D: Sensory evaluation**

- 93 Chapter 15. Introduction
- 94 Chapter 16. General guidelines for sensory evaluation
- 103 Chapter 17. Sensory evaluation of unroasted cacao beans as coarse powder
- 107 Chapter 18. Sensory evaluation of cacao beans as cacao mass
- 115 Chapter 19. Sensory evaluation of cacao beans as dark chocolate
- 118 Chapter 20. Tools for sensory evaluation

## **136 Annexes**

- 136 Annex 1. Steps for a randomised selection of specific bags in a lot
- 137 Annex 2. Quartering process diagrams
- 138 Annex 3. Example of calculation of moisture content using the oven method
- 140 Annex 4. Calculation of the standard deviation of the bean count
- 142 Annex 5. Examples of defective whole beans
- 143 Annex 6. Cut bean reference pictures
- 146 Annex 7. Examples of colour guides for picture taking
- 147 Annex 8. Cacao bean standards by country and organisation
- 152 Annex 9. Adjustments in roasting time and temperature by cacao bean size and moisture content
- 155 Annex 10. Use of micrometer to measure cacao mass particle size
- 159 Annex 11. Examples of calculation of ingredients for chocolate processing
- 160 Annex 12. Heating and cooling chocolate manually during tempering process
- 161 Annex 13. Tempering troubleshooting
- 162 Annex 14. All equipment, tools and materials

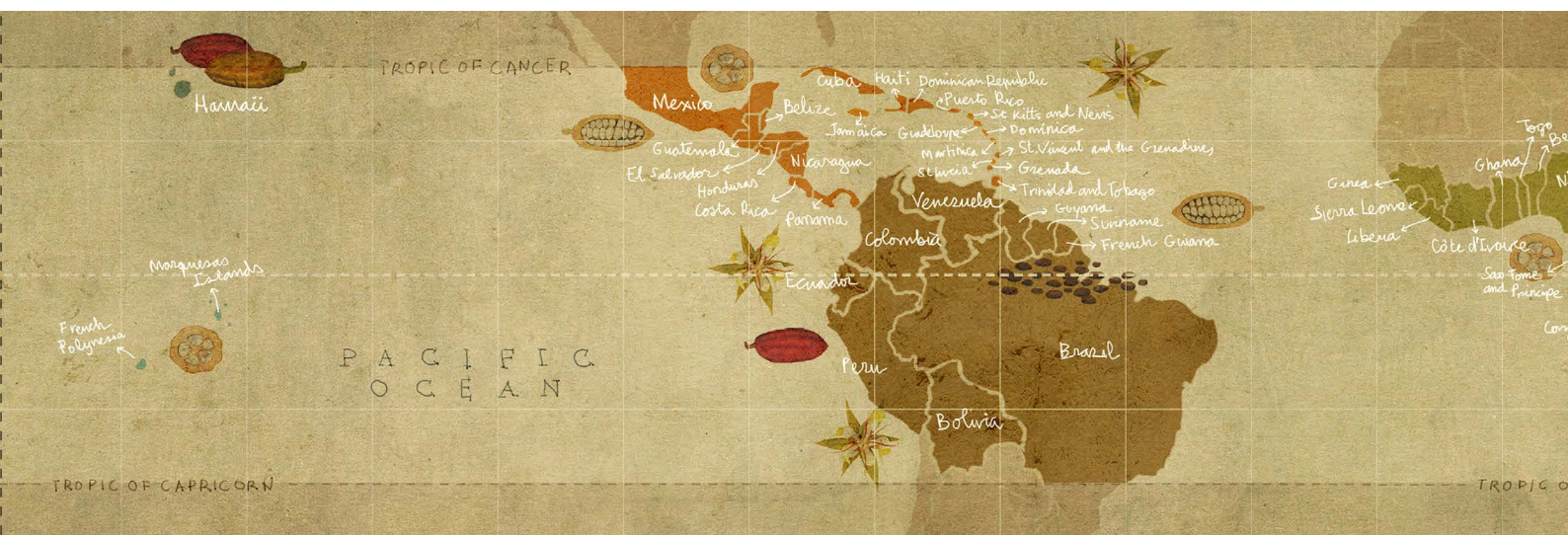
## **190 List of tables**

## **193 List of figures**

## **198 Contributors**

## **204 References**

# General introduction



Cacao quality and flavour are the result of various factors, including cacao variety, cultivation practices, environmental conditions, and processing techniques. These interactions give rise to the diverse tastes and aromas that characterise some of the world's best chocolates.



Surprisingly, until now, there has been an absence of commonly agreed protocols for assessing cacao quality and flavour. This discrepancy has hindered effective communication between buyers and producers, preventing farmers from maximising on the opportunities presented by superior quality cacao.

The purpose of this Guide is to change this situation. It is designed for individuals and organisations who aspire to establish comprehensive and standardised facilities and sensory evaluation panels for the assessment of cacao quality and flavour, based on international protocols. This Guide is the culmination of extensive consultations with a broad range of public and private sector stakeholders across the cacao value chain, from farmers, buyers, traders and manufacturers to academic researchers.

However, this publication goes beyond its role as an instructional manual. It is an educational resource that empowers cacao-producing origins to strengthen their position in the cacao trade, elevate the quality of their cacao production, and improve livelihoods and incomes. By enhancing the understanding of the unique flavours of diverse cacao varieties, this Guide fosters a deeper appreciation for and preservation of traditional cacao types.

We hope this Guide becomes the reference for all stakeholders within the cacao sector to elevate cacao quality and contribute to a more vibrant and equitable cacao community.

Led by Cacao of Excellence and the Alliance of Bioversity International and CIAT, this initiative has been conducted in collaboration with members of the ISCQF Working Group. The objective of this group was to review current practices and explore the development of internationally agreed and harmonised standards for assessing cocoa quality and flavour standards.

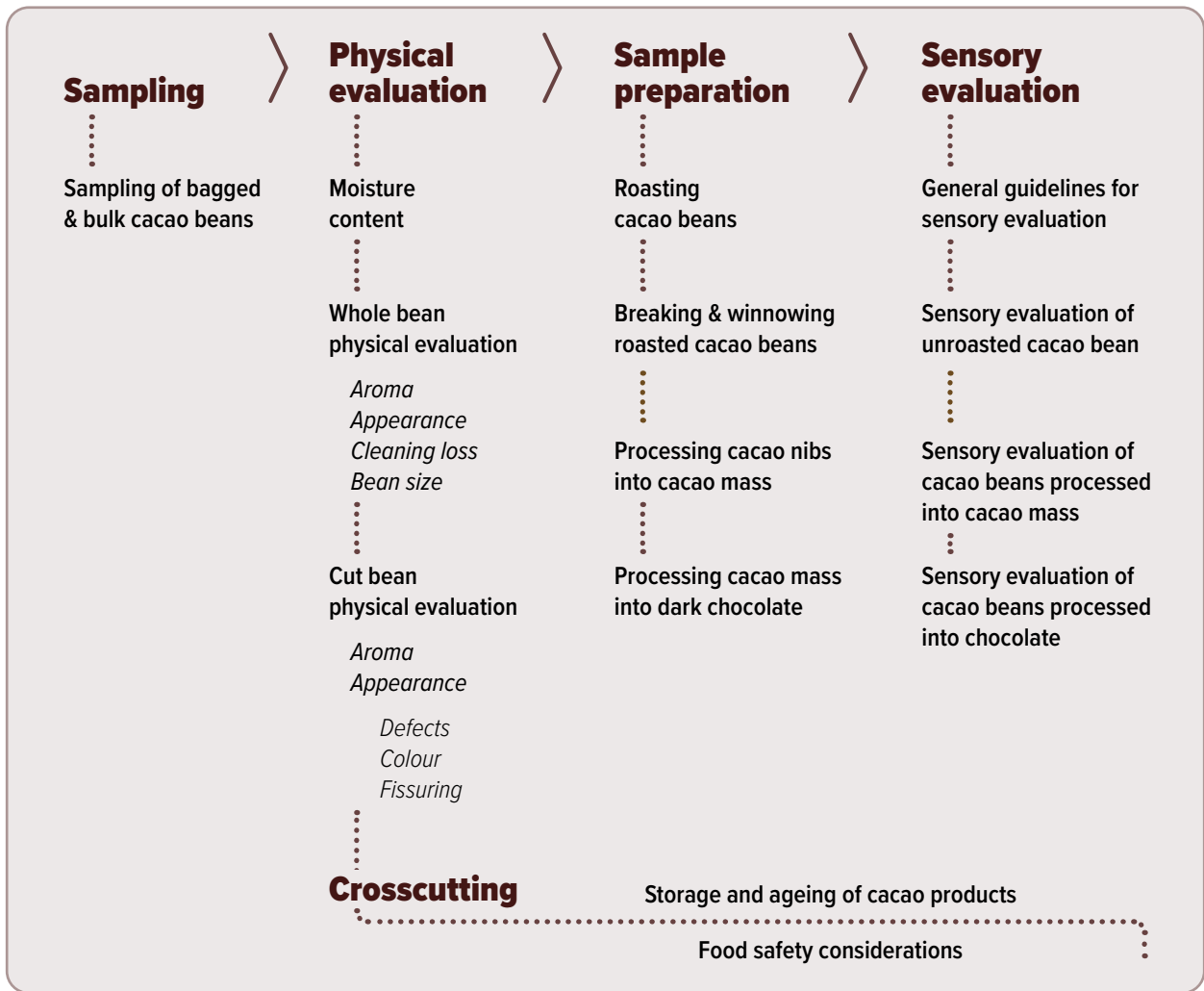
The objectives of this Guide are as follows:

- To facilitate communication and establish connections between cacao producers and supply chain operators to enhance market opportunities.
- To promote the use of a common and standardised language to facilitate effective communication and collaboration among laboratories, institutions, companies, and platforms involved in the cacao value chain.
- To enhance the capacity of producing origins to identify, pursue, value, and preserve cacao quality and diversity.
- To propose a potential international standard for assessing cacao quality and flavour and serve as a reference for international and national standards as well as training materials.
- To provide guidance and an interpretation of existing international standards, terms, and definitions published by relevant organisations such as the International Organization for Standardization (ISO), the Food and Agriculture Organization of the United Nations (FAO), and the World Health Organization (WHO).

It should be noted that this Guide is intended as a voluntary standard and not a mandatory requirement. Furthermore, the protocols can be applied to all cacao types.

The key elements of this Guide consist of protocols for various stages of cacao processing for quality and flavour assessment, including sampling, physical evaluation, sample preparation, and sensory evaluation, illustrated in Figure 1.





**Figure 1.** Elements of quality and flavour assessment included in this Guide.



## PART A | GENERAL CONSIDERATIONS

### Chapter 1. **Introduction**

Key considerations for the proper handling, processing, use and storage of cacao samples and products are essential preliminary steps for ensuring reliable quality and flavour assessments. These steps are detailed and complemented with a thorough description of food safety considerations to ensure that samples are free from contaminants, and that assessors can recognise when samples have been affected by pests or diseases.

This section summarises the key parameters and specifications for the all protocols, from sampling, physical evaluation, processing into cacao mass and chocolate and sensory evaluation.

Guidance is provided on the storage and ageing process of cacao beans, cacao mass (also known as mass), and chocolate, which is crucial for stabilising their flavour characteristics.

This section includes a comprehensive protocol for sampling bagged and bulk cacao beans to obtain a representative sample for further analysis and evaluation of a cacao bean lot.

## Ch 2. Key parameters and specifications

Establishing key parameters and specifications is essential to minimise variations and to ensure consistency among different laboratories and technicians who follow various protocols. The key parameters and specifications of the protocols in this Guide are listed in Table 1 below.

**Table 1.** Key parameters and specifications for all protocols.

Parameter	Specification
<b>Sampling</b>	
Percentage of bags of cacao beans to sample	30%
Minimum amount of cacao beans to sample per tonne	300g
Minimum size of cacao bean reference sample	2,000g
<b>Determination of moisture content</b>	
Minimum size of cacao bean test sample	500g
<b>Physical evaluation of whole cacao beans</b>	
Minimum size of cacao bean sample for sieving and calculating cleaning loss	500g
Minimum size of cacao bean test sample for bean count	500g
<b>Physical evaluation of cut cacao beans</b>	
Minimum size of cacao bean test sample for the cut test	300 cacao beans
<b>Roasting cacao beans</b>	
Minimum size of cacao bean test sample	600g
Type of oven	Laboratory forced-air convection oven
Basic roast type: temperature and time	<b>Light:</b> 112°C (234°F) x 25min <b>Medium:</b> 120°C (248°F) x 25min <b>Full:</b> 130°C (266°F) x 25min
Adjustments to roasting temperature and time	Based on bean size and moisture content
<b>Breaking and winnowing cacao beans</b>	
Minimum size of cacao bean test sample – output of roasting	600g
Target for the shell-to-nib ratio – visually	0%
<b>Refining cacao nibs into cacao mass</b>	
Minimum size of cacao bean test sample – output of roasting	600g
Target for the final particle size of cacao mass	14–20µm
Maximum temperature for cacao mass processing	55°C (131°F)
<b>Processing cacao mass into dark chocolate</b>	
Target for the final particle size of the chocolate	≤18µm
Maximum temperature for the chocolate processing	55°C (131°F)
% of cacao mass	63
% of cacao butter	7
% of sugar	30
Total % cacao	70

Parameter	Specification
<b>Sensory evaluation of cacao beans as mass</b>	
Quantity of cacao mass for sensory evaluation per tasting	1–2g
Volume of the container for the cacao mass sample	28ml with lid
Temperature of the cacao mass sample	Melted at 48–50°C (118–122°F)
Maximum time that the sample should be at 48–50°C (118–122°F) heated only once, not reheated	5 minutes
<b>Sensory evaluation of cacao beans as dark chocolate</b>	
Quantity of dark chocolate for evaluation per tasting	2–3g
Temperature of the dark chocolate sample at the time of sensory evaluation	Room temperature
<b>Sensory evaluation of cacao beans as mass and as dark chocolate</b>	
Palate cleanser between sensory evaluation of a sample	Non-yeast, unsalted and flavourless water crackers and warm water at 40–50°C (104–122°F)
Minimum number of assessors in a sensory evaluation panel for conventional sensory profiles (data-based average)	6
Minimum number of assessors in a sensory evaluation panel for consensus sensory profiles (agreed final values)	4
Maximum number of cacao mass samples tasted during an evaluation session	6
Minimum number of known reference cacao mass samples tasted prior to each evaluation session for calibration	2
Flavour attributes (core and complimentary) to be evaluated	Glossary of terms
Scale for intensity of flavour attributes and global quality	0–10

### Ch 3. Food safety considerations

Ensuring food safety practices such as good hygiene and manufacturing practices is critical in the implementation of a Hazard Analysis and Critical Control Points (HACCP) system. Hygienic restrictions, pest management and foreign object prevention can avoid introduction of contaminants, pests or diseases into cacao products during the quality and flavour assessment process.



N'Koh Ambroise Côte d'Ivoire

The general components of good hygiene and manufacturing practices include the following:

- Personnel.
- Raw materials, food ingredients, and other products.
- Facilities.
- Equipment, tools and apparatus.
- Facility maintenance, equipment service and calibration; and
- Cleaning and sanitising.

The management team of any cacao quality and flavour assessment facility must document in written form, communicate, implement and evaluate good hygiene and manufacturing practices within the organisation on a regular basis, in order to ensure that food safety objectives are fulfilled.

Detailed guidelines for good hygiene and manufacturing practices during the stages of sampling, physical evaluation, sample preparation and sensory evaluation of cacao beans are presented in Table 2. These guidelines are based on recommendations developed by the Food and Agriculture Organization (FAO) and the World Health Organization (WHO) (FAO, WHO 2020).

**Table 2.** Guidelines for Good Hygienic and Manufacturing Practices for cacao quality and flavour (Bioversity International\Dolores Alvarado, 2022 based on FAO and WHO, 2020).

Components	Guidelines
<b>Personnel</b>	<p>Use of Personal Protective Equipment (PPE) such as laboratory coats (ideally with inside pockets), hair and beard coverage, footwear and goggles, must be observed whenever applicable.</p> <p>Cuts and wounds, especially for personnel assigned in the processing and analysis area, must be covered by suitable water-proof dressings.</p> <p>Wearing of jewelery, nail varnish, false nails and other loose personal items must be restricted within the processing and analysis areas.</p> <p>Everyone entering the premises (e.g. employees and visitors) must strictly adhere to basic personal hygiene norms, including but not limited to: thorough handwashing and drying, prevention of hand-to-face contact, avoidance of eating outside the designated area and reporting cases of sickness.</p>
<b>Raw materials, food ingredients and other products</b>	<p>Sample providers of cacao beans for analysis must be reminded of and must comply with the food safety guidelines prescribed, e.g. samples, impurities, pesticide treatments, etc.</p> <p>Unroasted cacao beans must be kept segregated from cacao products derived after roasting, i.e. nibs, cacao mass and chocolates.</p> <p>Ingredients used for the processing of cacao products (e.g. sugar, lecithin, cacao butter) must be sorted and kept separate from materials and substances unfit for human consumption (e.g. cleaning chemicals).</p>
<b>Facilities</b>	<p>Handling of raw or unprocessed materials (i.e. unroasted cacao beans) and processed products (i.e. roasted beans, nibs, cacao mass, chocolates) must be carried out in separate areas.</p> <p>Use of glass items in the processing area must be minimised; glass items such as light bulbs or lamps in working areas must be protected.</p> <p>Use of wood, due to the potential risk of splintering, must be limited.</p>

**Components**
**Guidelines**

The facility, particularly the processing area, must be pest-proof. This can be done by screening windows, closing gaps below doors, and installing effective pest control systems such as insect and rodent traps, and baits.

Designated areas and/or containers for stray items (e.g. loose nuts and bolts), collected foreign materials (i.e. protocol for cleaning loss) and other waste (including disposable Personal Protective Equipment – PPE) must be established.

Proper ventilation is crucial, particularly in processing and storage areas, to minimise airborne contamination of cacao products during processing.

Adequate natural or artificial lighting must be installed following prescribed standards, i.e. luminosity requirements for external analysis and cacao bean cut tests.

Water used for processing and cleaning must be of potable quality, i.e. meeting or exceeding minimum microbiological safety standards.

Appropriate control systems must be in place for temperature, humidity, and other environmental factors whenever possible.

Personal hygiene facilities, such as a handwashing station, must be available, designed and constructed to facilitate the maintenance of personal hygiene.

**Equipment, tools, and apparatus**

Equipment must be installed in a manner that allows for adequate maintenance, cleaning and monitoring.

Tools such as knives, spatulas and scoops must have solidly built and clearly designated storage locations.

Sampling scoops, spears and related tools must be kept clean, free of build-up and in good condition.

Reusable storage containers (e.g. made of plastic) must be inspected for signs of physical damage prior to use.

Processing-related equipment such as mills, grinders and melangers must be covered during use whenever possible.

Residues, leaks and spills that may arise from sample preparation within the surrounding area must be immediately cleaned and disposed of properly.

**Facility maintenance, equipment service and calibration**

*Salmonella* testing must be regularly performed on the facility, following a risk-based approach, i.e. areas within the facility have different levels of risk for *Salmonella*.

Routine preventative maintenance must be applied on the premises, such as on roofing and storage bins, in order to minimise the presence of foreign objects, such as pieces of metal, concrete or glass.

Storage facilities (e.g. bins and compartments) must be cleaned and disinfected on a regular basis, especially when they are used to store raw materials or waste products that are highly contaminated with insects, mould and *Salmonella*.

Exposed food contact surfaces must be routinely examined and, if possible, be protected from potential contamination.

Screws, nuts, bolts and other potentially loose items must be periodically inspected and fixed in appropriate equipment and facilities.

Chemicals used for maintaining processing equipment and tools (e.g. oils and greases) must be of food-grade quality, as they may come into contact with cacao products during processing.

Preventive maintenance, such as lubrication with food-grade agents, must be performed on equipment and tools that pose high risks for foreign objects due to breakage.

A sampling plan to monitor the microbiological status of food contact surfaces and other equipment for processing cacao products must be established.

A general and preventive maintenance programme for equipment impacting product safety and quality must be established, which considers: (1) a priority system to address product safety and quality issues, (2) a process system for adding new or upgrading existing equipment, and (3) verification documents that support the completion of maintenance work.

**Cleaning and sanitising**

Cleaning and sanitising schedules must be established and supported by documented records of completion.

Sponges, reusable cloth towels and wooden-handled tools must not be used for cleaning.

Cleaning materials must be fit for purpose and designed to minimise risks for physical hazards, e.g. use of cleaning brushes with resin-bonded bristles instead of wire brushes or scouring pads that pose risks of physical hazards.

Similar cleaning tools (e.g. brushes) must be colour-coded to distinguish between specific uses, i.e. for food contact surfaces versus general cleaning purposes.

Cleaning chemicals must be prepared according to prescribed instructions and must be carefully handled and disposed of.

Containers for waste, by-products and other non-food or toxic substances must bear proper identification and be suitably constructed, i.e. made of impervious material.

The identification of food safety risks are carried out following the HACCP approach, described in Table 3 below.

**Table 3.** Basic principles of the HACCP approach (US FDA, 2017; Velmourougane et al., 2014).

	<b>Principles</b>	<b>Steps</b>
<b>1</b>	<b>Conduct a hazard analysis</b>	<ul style="list-style-type: none"> <li>• Identify hazards.</li> <li>• Assess the risks associated with each hazard at each step in the system.</li> <li>• Describe possible control measures.</li> </ul>
<b>2</b>	<b>Determine the critical control point/s (CCPs)</b>	<ul style="list-style-type: none"> <li>• Identify the step/s in the process at which control measures can be applied that will prevent or eliminate a food safety hazard or reduce it to an acceptable level.</li> </ul>
<b>3</b>	<b>Establish critical limit/s</b>	<ul style="list-style-type: none"> <li>• Establish the critical limit/s at each control measure associated with a CCP.</li> <li>• Use critical limits to separate acceptable from unacceptable control parameters.</li> </ul>
<b>4</b>	<b>Establish a monitoring system</b>	<ul style="list-style-type: none"> <li>• Plan monitoring procedures that describe how, when, and how often to measure the critical limits at each CCP, and determine who is responsible for measuring them.</li> <li>• Monitoring procedures must be designed to determine when deviations from the critical limit occur so that appropriate corrective actions can be initiated.</li> </ul>
<b>5</b>	<b>Establish corrective action/s</b>	<ul style="list-style-type: none"> <li>• Identify the steps that must be taken to prevent potentially hazardous items (e.g. contaminants) from entering the process.</li> <li>• Determine the steps necessary to correct any deviation from the established critical limit/s when monitoring a CCP.</li> </ul>
<b>6</b>	<b>Establish verification procedure/s</b>	<ul style="list-style-type: none"> <li>• Audit the HACCP plan to review deviations.</li> <li>• Conduct random sampling and checking to validate the whole plan.</li> </ul>
<b>7</b>	<b>Establish documentation</b>	<ul style="list-style-type: none"> <li>• Establish documentation concerning all procedures and records appropriate to these principles and their application.</li> </ul>

Hazards are classified into three categories: biological, chemical, and physical. When conducting a cacao quality and flavour assessment, it is crucial to consider the hazards commonly associated with cacao products. Some important hazards to be mindful of include:

- **Biological:** insects, rodents, *Salmonella*.
- **Chemical:** heavy metals (arsenic, cadmium, lead, mercury), pesticide residues, mycotoxins (aflatoxin and ochratoxin A), polycyclic aromatic hydrocarbons and mineral oil residues, such as mineral oil saturated hydrocarbons and mineral oil aromatic hydrocarbons.
- **Physical:** plastic pieces, metal shavings, wood splinters, glass pieces, human hair, small stones, dust, and fibres.

Similar to any raw agricultural product, cacao beans may contain pathogens that pose a food safety hazard. In order to avoid contamination of processed materials (e.g. cacao mass or chocolate for sensory evaluation), unroasted beans must be handled (i.e. during sampling) and kept in a room separate from roasted beans, nibs, cacao mass and chocolate. If they must be handled in the same space, use a batch system to work in separate time frames. Clean and disinfect all counter spaces, contact surfaces and tools between batches.

For cleaning and sanitising all surfaces, tools and equipment, use food-grade and odourless cleaning agent and disinfectants. Two options for basic disinfectants are:

- 70% isopropyl alcohol spray.
- 1% sodium hypochlorite solution that can be prepared by mixing nine parts of potable water and one part 10% sodium hypochlorite concentrate. Once prepared, the disinfectant or solution has a shelf life of six months.

For all protocols where raw beans are being handled, i.e. Chapter 7 'Determination of moisture content', Chapter 8 'Physical evaluation of whole cacao beans' and Chapter 9 'Physical evaluation of cut cacao beans', it is important to consider the following recommendations:

- Bags for holding samples must consist of food-safe material, including food-safe marking and labeling such as ink or paint. Bags should be new, clean, sufficiently strong and properly sewn.
- The surface where samples are handled must be clean before the process is carried out.
- Samples must be placed in separate and clean containers (e.g. plastic bags) that are sealed and properly labelled.
- Face masks or protective goggles must be worn particularly for moving bean lots where a stream of dust is consistently produced.
- Used personal protective equipment must be removed such as face masks and safety goggles and disposed of or thoroughly cleaned.



- Thoroughly wash and/or sanitise hands employing the following techniques, illustrated in Figure 2 below.

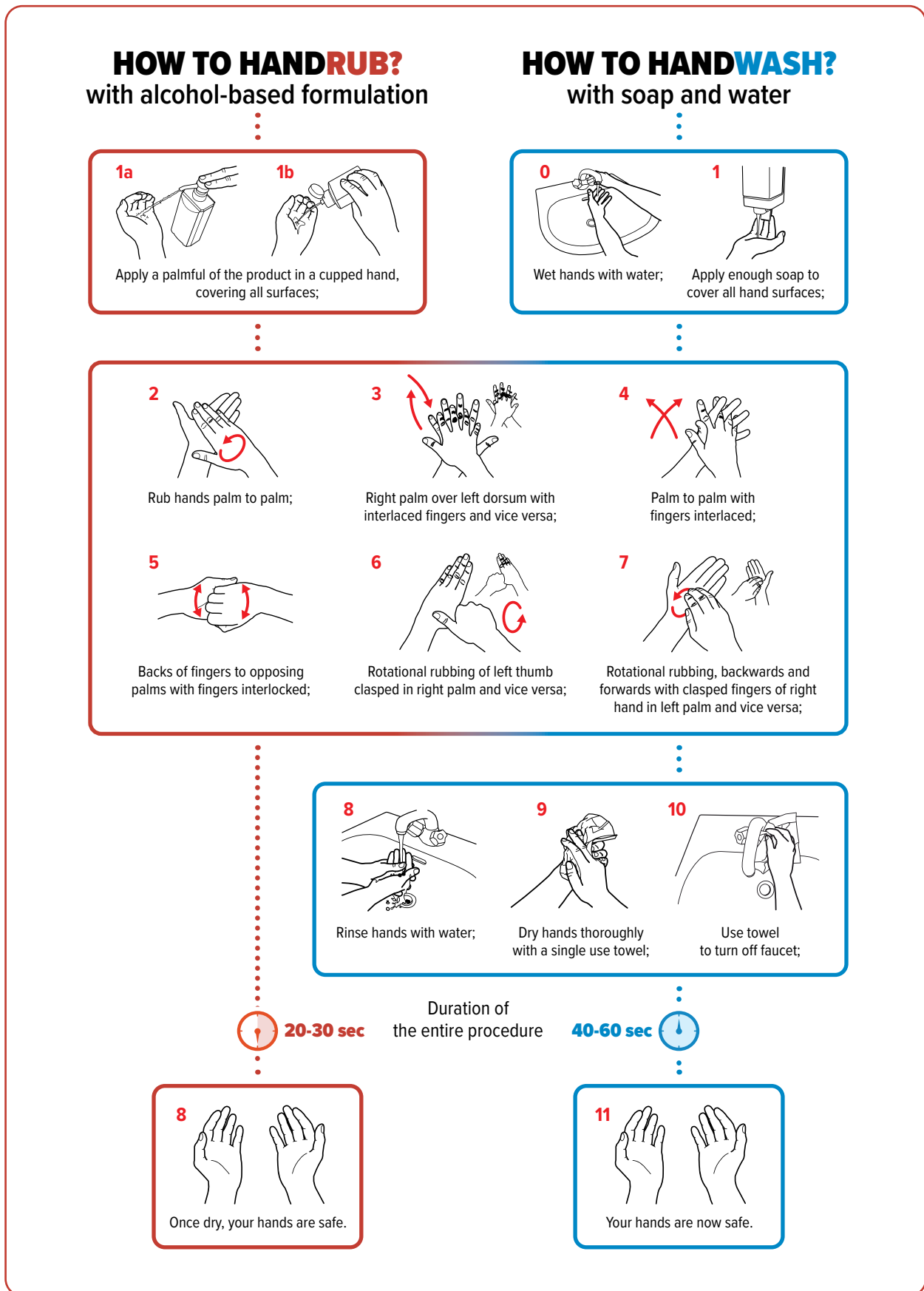


Figure 2. Proper hand washing and sanitising techniques (WHO, 2006).

## Ch 4. Storage and ageing of cacao products

Proper storage of cacao products is crucial to maintain optimal quality and flavour from the initial sampling stage to the assessment process and subsequent storage. Optimal storage conditions including room-layout characteristics and environmental conditions are detailed below.

### 4.1 Storage room

#### Room layout

- Floors and walls must be made of concrete and/or bricks.
- Room doors and windows must provide adequate light and ventilation, while effectively preventing the entry of pests such as birds and rodents.
- Storage areas should be equipped with provisions to keep different bean lots (such as roasted and unroasted nibs) separated by a distance of at least 60cm. This separation is necessary to prevent mixing and cross-contamination between the different lots.
- Storage areas, cabinets and containers for cacao products must be clean and free of foreign matter, such as dirt, dead insects, pupal cases and webbing.
- Cacao products must be stored on gratings, deckings or vessels that are  $\geq 7$ cm off the ground and  $\geq 60$ cm away from ceilings and walls, for sufficient air circulation and distance from any contaminating matter, such as insects and paint.

#### Environmental conditions

- Cacao products should not be stored with odour-releasing items, such as cleaning agents, spices, herbs and flavouring.
- Cacao products should be kept away from direct sunlight or any heat source to prevent temperature differentials, water migration or fat degradation.
- Fluctuations in temperature and relative humidity (RH) should be avoided.
- The RH should be kept at less than 70% to prevent or reduce mould growth.
- The optimal duration and temperatures for specific cacao products are listed in Table 4.

**Table 4.** Optimal temperature and relative humidity for storing cacao products to maintain quality and flavour.

Product	Duration	Temperature	RH
<b>Cacao beans</b>	<3 months	23–33°C (73–91°F)	65–75%
	>3 months	20–24°C (68–75°F)	
<b>Cacao nibs for processing into cacao mass</b>	No more than 7 days	10–24°C (50–75.2°F)	
<b>Cacao mass</b>	<3 months	$\leq 22^\circ\text{C}$ (71°F) – ambient	
	>3 months <1 year	5–8°C (41–46°F) – fridge	
	>1 year	-18 to -5°C (0–23°F) – freezer	
<b>Chocolate</b>	<2 years	10–18°C (50–64°F)	

## 4.2 Packaging and labelling

Adequate packing of stored cacao products (beans, nibs, cacao mass, chocolate) must prevent rewetting, degradation and cross-contamination. The packing materials must possess the following characteristics:

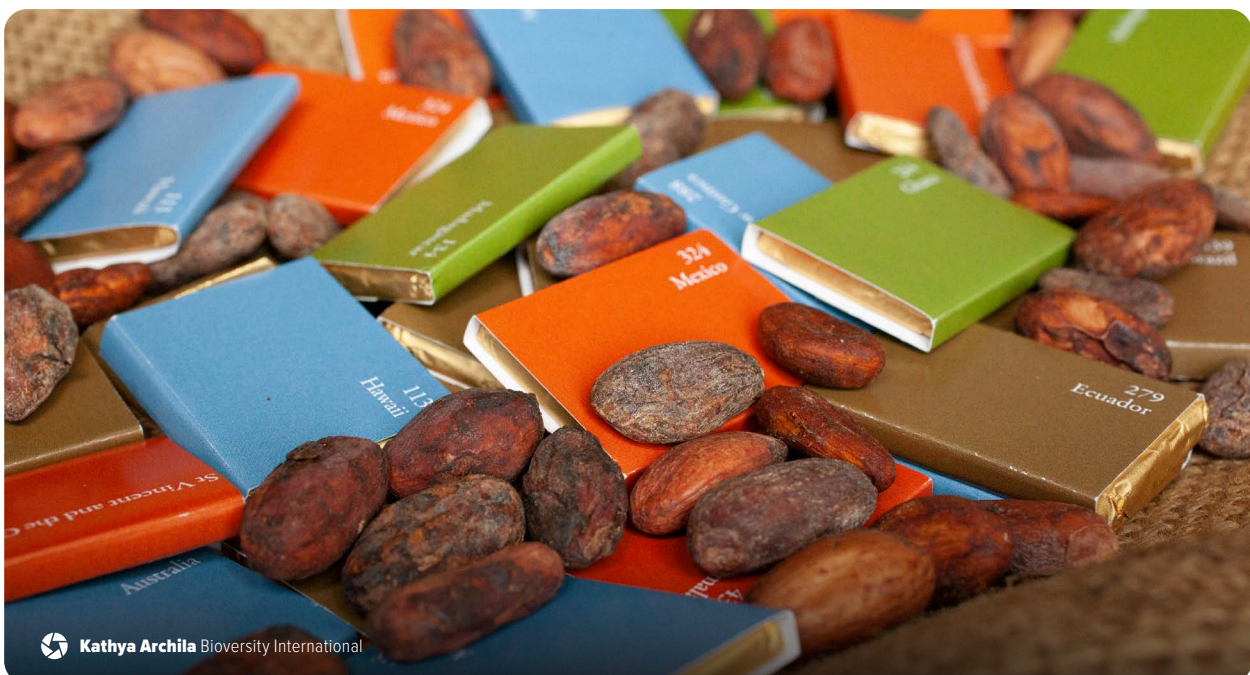
- Sufficiently strong, properly sewn or tightly sealed to withstand transport and storage.
- Suitable for food contact use and discouragement of pest infestation.
- Good oxygen and moisture barrier properties.
- Free of noxious substances such as mineral oils.
- Snap- or vacuum-sealable plastics bags made from any of the following:
  - » Linear low density polyethylene/vinyl alcohol.
  - » Oriented polypropylene/polypropylene.
  - » Oriented nylon/polyethylene.

Stored cacao products must be clearly labeled with the following information, where applicable:

- Name of the product (i.e. beans, nibs, cacao mass, chocolate).
- Internal code reference (i.e. sample code).
- Properly identified cacao bean lots, either at farm-level or out-of-farm warehouse.
- Date of receipt of the product (dd/mm/yyyy).
- Location of storage (room, shelf, box).



**NOTE:** In order to prevent condensation, bring any cold cacao mass samples to room temperature while inside their packing or jars. If the cacao mass samples are large and deep frozen, they should be left to thaw and reach room temperature (20–22°C or 68–72°F) overnight. If the room temperature is higher, the thawing should be done in two steps: (1) Transfer from freezer to fridge and (2) cool to room temperature overnight. This approach will minimise the chance for condensation.



## Ch 5. Sampling bagged and bulk cacao beans

### 5.1 Objective

This protocol outlines the procedure for sampling various lots of cacao beans with the aim of obtaining a representative sample for further analysis and evaluation. The objective is to ensure that the sample accurately represents the entire cacao bean lot being assessed.

### 5.2 Key specifications

**Table 5.** Key specifications for sampling.

	Parameter	Specification
	Percentage of bags to sample	30% (ISO, 2292:2017)
	Minimum amount of cacao beans to sample per tonne	300g
	Minimum size of the reference sample of cacao beans	2,000g

### 5.3 Equipment, tools and materials

- Sampling spear (Annexes, Figure 43).
- Handheld sampling scoops (Annexes, Figure 44).
- Plastic or metal storage containers (Annexes, Figure 46).
- Quartering tools (Annexes, Figure 47).
- Weighing scales with a minimum capacity of 2kg and a precision of 0.5g.
- Bags used to hold reference samples should have the following characteristics:
  - » Food-grade non-toxic marking and labeling inks or paints.
  - » New or recycled, clean, sufficiently strong and properly sewn.

### 5.4 Procedure

#### 5.4.1 General

Bean lots can be either in bags or in bulk. Different samples are taken during the process to ensure maximum representation of the lot and are defined as follows:

- **Primary samples** are small quantities of beans taken at a single position from a randomly selected bag.
- **Incremental samples** are small quantities of beans not exceeding 1kg taken from a bulk lot.
- **Composite samples** are all primary or all incremental samples combined and thoroughly mixed to homogenise.
- **Reference samples** are the targeted representative samples of 2kg obtained by successively quartering the composite sample for physical and sensory evaluation.
- **Test samples** are taken from the reference sample, amount to at least 500g, and are withdrawn using a flat-bottomed shovel drawn across the middle of the reference sample to carry out a specific test.

The sampling process should be conducted and completed within the same day, without interruption, to ensure representation of the sample lot at a specific point in time.

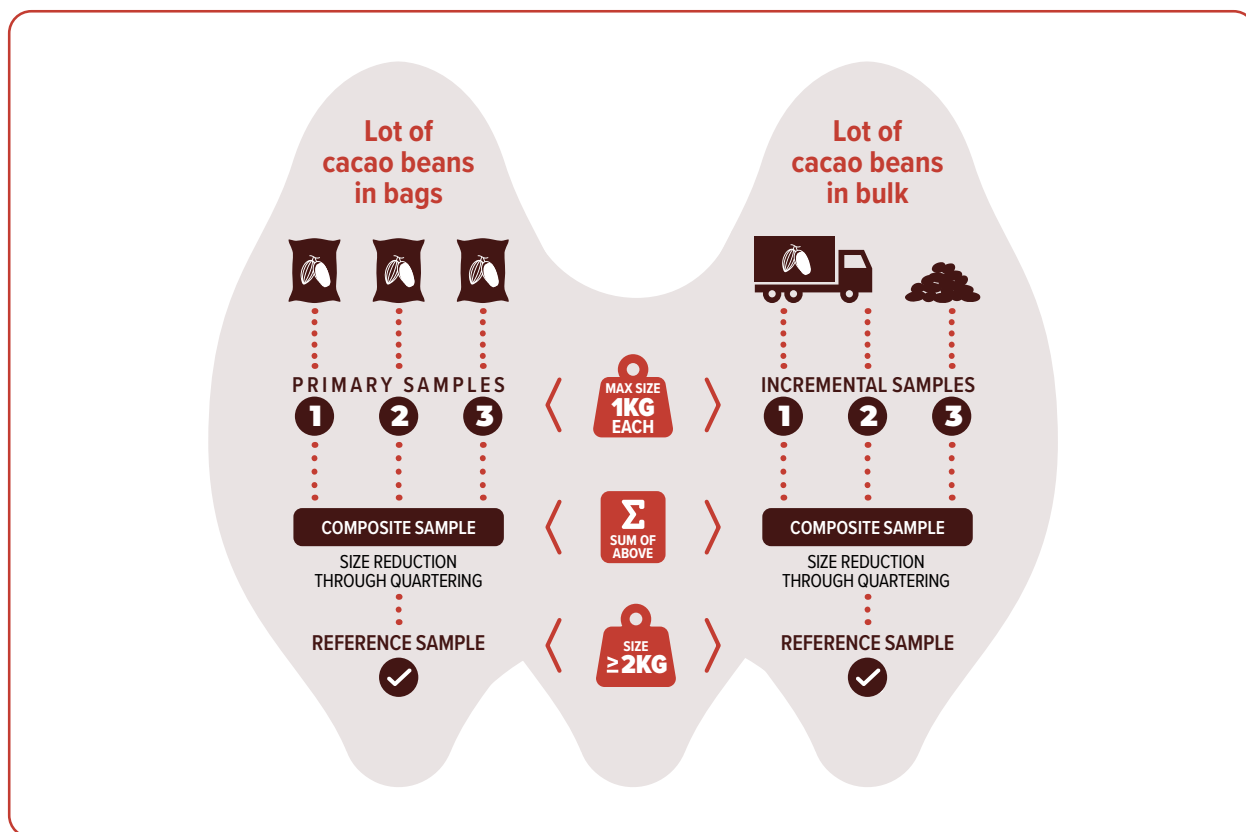
In order to obtain accurate representative samples, the sampling procedure must consider proportional allocation with respect to the size of the original lot and minimise bias in obtaining the samples. These are addressed in this protocol by recommending minimum sample sizes according to lot size and by applying randomisation aided by tools (e.g. sampling spear, quartering tool).

Sampling very large or very small bean lots will present challenges and will require adapting the sample size.

The sampling procedure can be modified to suit the needs of the user, particularly for the purpose of analysing the bean lot. Although the sizes of lots may vary, the approach to sampling as described in this protocol remains the same.

In scenarios where the user suspects a high degree of variability within the lot, it may be best to draw an initially larger sample than the recommended minimum. Once this first stage has been completed, additional sample reduction steps are used (e.g. quartering) to obtain the final representative sample.

A reference sample of 2kg is targeted and will yield sufficient test samples to carry out all of the protocols of this guide as shown in Figure 6. However, a larger reference sample may be required if more cacao mass or chocolate is needed for sensory evaluation. If backup samples are required, they should be the same size as the reference sample. The general process for sampling and types of samples are illustrated in Figure 3 below.

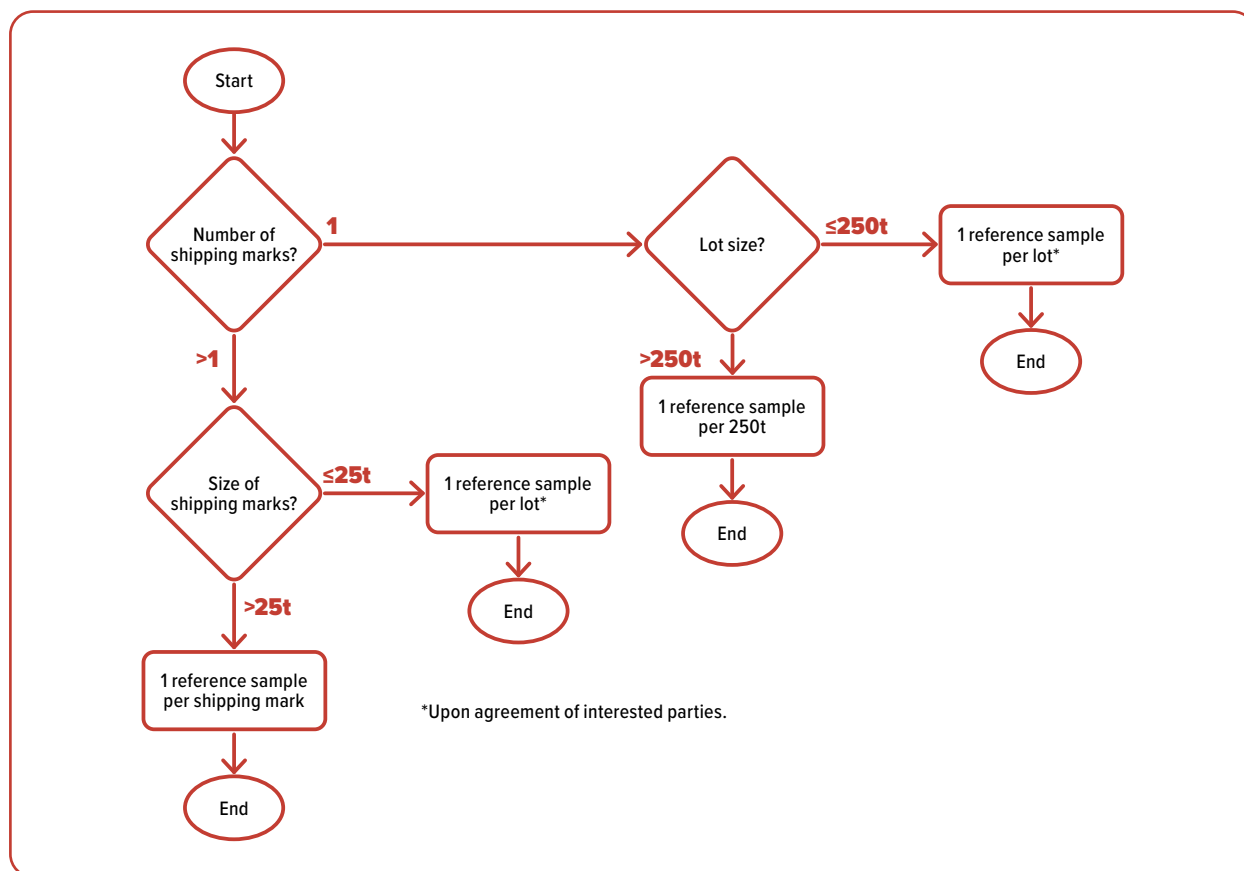


**Figure 3.** Schematic representation of the sampling process and types of samples (based on: ISO, 2292:2017 and ISO, 2451:2017).

## 5.4.2 Sampling beans from bags

The procedure for sampling beans from bags is outlined below:

1. Determine the minimum number of reference samples, each weighing a minimum of 2kg, based on the size of the lot and the number of shipping marks. This can be done by referring to the decision tree provided in Figure 4 below.



**Figure 4.** Decision-tree to determine the minimum number of reference samples (t=tonne).



**NOTE:** A shipping mark is the identification of an owner of a bag of cacao beans at some point in the supply chain up to the port of loading (i.e. a producer or trader). Shipping marks are usually stencilled on bags. A sender may aggregate cacao from different sources with different shipping marks into a lot.

2. When extracting the primary samples, sample a minimum of 30% of the bags in the lot. Draw enough cacao beans to get a minimum of 300g of bean material per tonne in the composite sample.



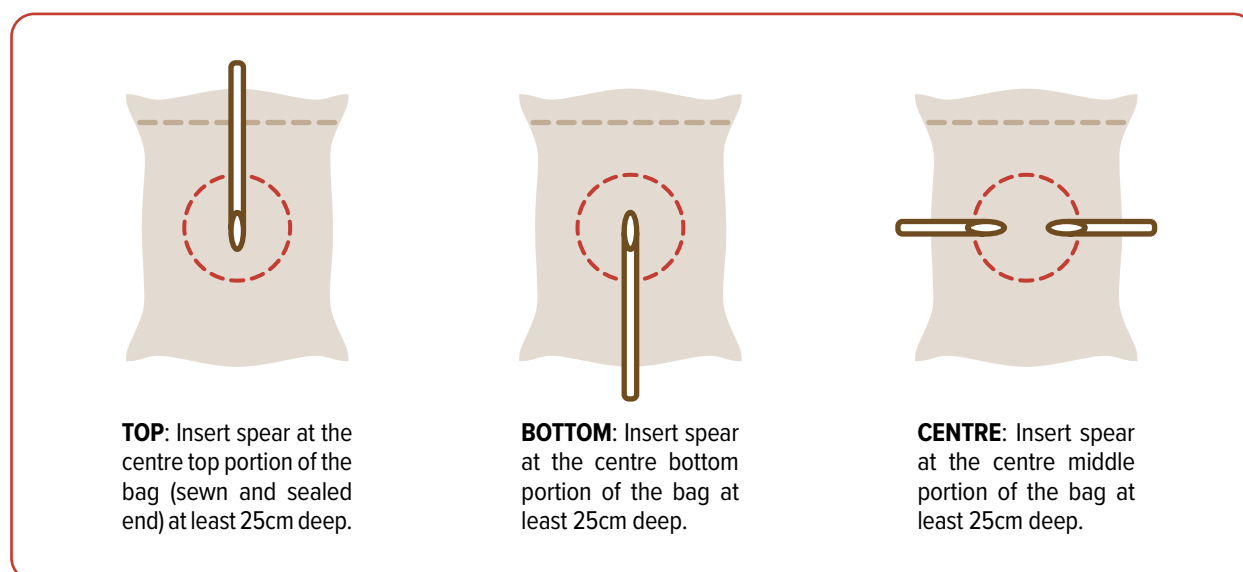
**NOTE:** These two specifications are minimums and both must be fulfilled. In bigger lots, a bigger composite sample may be needed in order to get 300g of bean material per tonne. In smaller lots, sampling the requirement of 300g of bean material per tonne may be exceeded in order to get a 2kg reference sample. Both situations are acceptable as they are higher than the minimum specifications.

Choose bags from all around the area occupied by the lot and avoid sampling only adjacent bags. Randomly selecting the specific bags to sample is the preferred approach (refer to Annex 1). However, in certain situations, it may be more practical to use the guidelines provided in Table 6 below. This table can assist in selecting the bags to sample and estimating the amount of beans to be taken from each bag to meet the specified requirements. Variations may occur due to the weight of the bags and the average weight of individual beans.

**Table 6.** Guide to sampling bagged cacao beans by lot size (assumption: bag weight of 65kg).

Bag weight	Lot size (t)	Number of bags in the lot	Recommended amount of bags to sample	Number of sampled bags	Recommended size of composite sample (kg)	Beans to take from each bag (g)
<b>60kg</b>	<1	Variable	50% – each 2 <sup>nd</sup> bag	Variable	2	250
	1	17	33% – each 3 <sup>rd</sup> bag	6	4	700
	10	167	33% – each 3 <sup>rd</sup> bag	55	4	75
	12	201	33% – each 3 <sup>rd</sup> bag	66	4	60
	20	334	33% – each 3 <sup>rd</sup> bag	110	8	75
	24	401	33% – each 3 <sup>rd</sup> bag	132	8	60
.....						
<b>30kg</b>	<1	Variable	50% – each 3 <sup>rd</sup> bag	Variable	2	150
	1	34	33% – each 3 <sup>rd</sup> bag	11	4	350
	10	334	33% – each 3 <sup>rd</sup> bag	110	4	50
	12	401	33% – each 3 <sup>rd</sup> bag	132	4	30
	20	667	33% – each 3 <sup>rd</sup> bag	220	8	50
	24	801	33% – each 3 <sup>rd</sup> bag	264	8	30

- Clean and dry the tools and equipment to be used during the sampling process.
- Choose sampling points within each bag at different positions to ensure an equal distribution of samples are collected from the top, centre and bottom of the bags. If only one position is sampled per bag, vary the sampling point from bag to bag, depending on the points that are accessible if, for example, bags are packed on a pallet. Use Figure 5 below as a guide.



**Figure 5.** Sample collection using a spear from an undamaged bag.

5. Make a hole in the bag using the sampling spear.
6. Extract the primary sample through the hole created using the sampling spear.
7. Close the hole created in the bag to minimise further damage, e.g. by using packaging tape. In case of jute sacks, this can easily be done by pushing the jute fibres around the sampling point toward the centre of the hole.



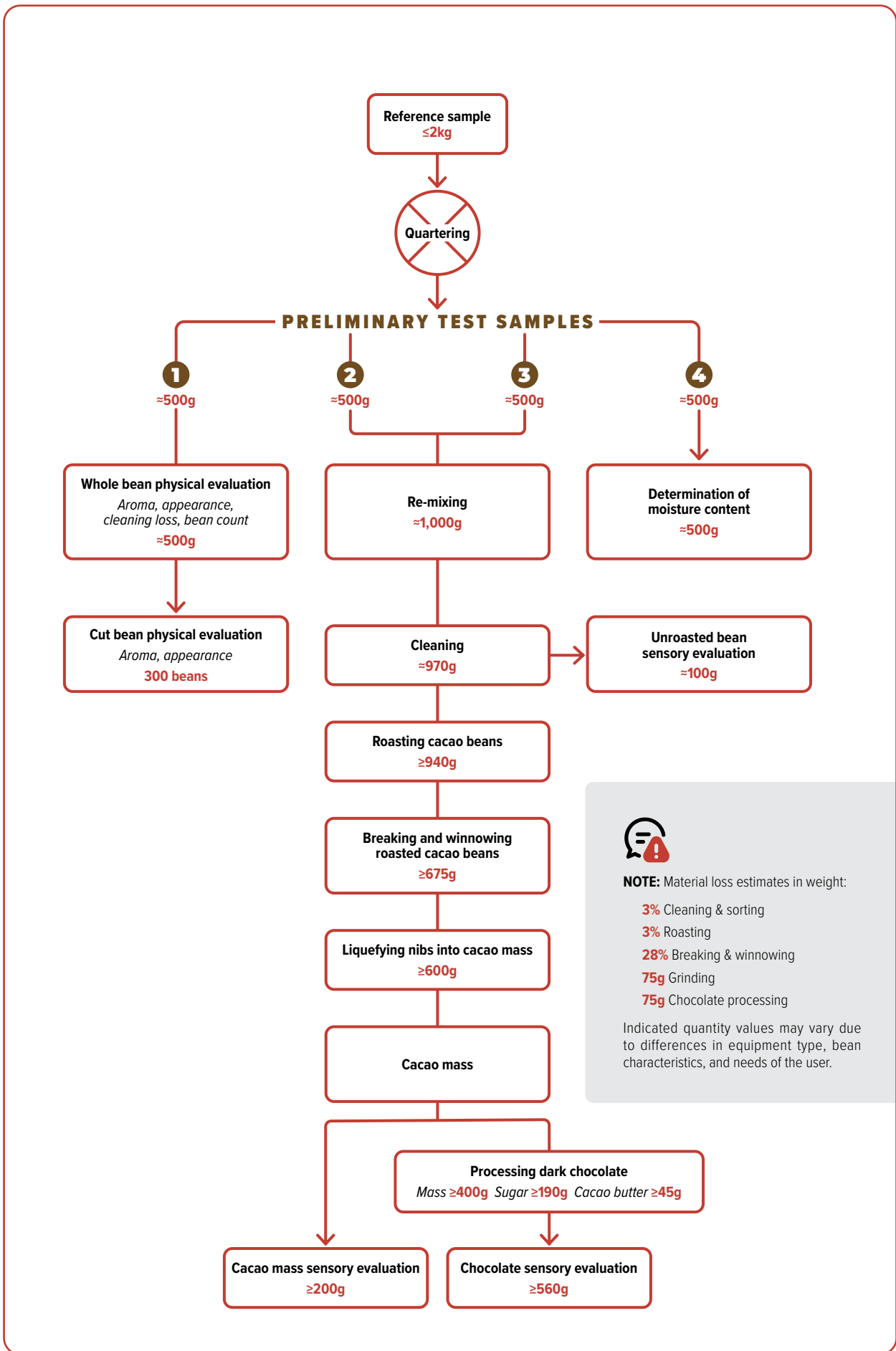
**NOTE:** If the bags are meant to protect the beans from moisture and should not be punctured, take the samples by opening each sampled bag and retrieve the beans from different positions. Use a special sampling spear as shown in 'Annexes', Figure 43d. If not available, it is necessary to pour out the beans on a clean surface and take the beans from the pile.

8. Collect all primary samples into a clean storage vessel or bag.
9. Empty the primary samples on a clean flat surface in an area free of contamination.
10. Immediately mix the collected primary samples carefully and thoroughly with the sampling spoons to get the composite sample.
11. Divide the composite sample by quartering to obtain the reference sample (see Annexes, Figure 28 and Figure 29 for visuals):
  - Clean the surface where the quartering will take place.
  - Tip the composite sample onto the surface.
  - Gather the beans into a cone shape.
  - Flatten the cone forming a circular shape or ellipse.
  - Divide the circular shape into halves.
  - Divide each half into quarters.
  - Discard beans from the first and last quarters (in a diagonal position).
  - Mix quarters two and three.
  - Repeat the procedure until the targeted amount of beans has been obtained.



**NOTE:** Quartering can also be carried out using special devices, such as a quartering tool (Annexes, Figure 47). Using such devices carries a risk that should not be underestimated, as it can potentially result in the creation of more broken beans, fragments, residue, and other undesirable elements. Samples of cacao should be drawn and quartered carefully and gently. The beans should not be subjected to rough handling.

12. Pack the reference sample in a new bag and promptly seal it.
13. Label the bag with an identification (number, name, code, etc.) that links it to the data associated to the sample. This data may be different from case to case.
14. Bag, label and store the excess beans from the composite sample with the original lot of beans.
15. Take test samples for each analysis of the physical and sensory quality evaluation. The recommended amounts are based on a preliminary test sample (defined by ISO 2451:2017 as a "quarter of the reference sample obtained by using a splitter/divider, which can be less than 600g") and are illustrated in Figure 6. If the test is non-destructive, the samples can be reused.



**Figure 6.** Chart illustrating the splitting of a 2kg reference sample into preliminary test samples for all evaluations described in this guide (based on ISO 2451:2017).

### 5.4.3 Sampling cacao beans from bulk

Sampling beans from bulk involves taking incremental samples while the lot is in motion during loading or discharging. The following steps should be followed:

1. Calculate the duration of sampling intervals for a lot in motion considering the capacity of the hand scoop/s, the time required to load or discharge the beans (t) with 2kg as the minimum size of the reference sample. Use Formula (1) in Figure 7 below.

#### Definition of variables

- t:** total time required to load/discharge the beans in minutes
- s:** capacity of hand scoop in kilograms (kg)
- w:** minimum weight of reference sample in kilograms (kg)
- n:** number of sampling points
- i:** duration of sampling intervals in minutes

#### Formula

(1) Number of sampling points:  $n = \frac{W}{s}$                       (2) Sampling intervals:  $i = \frac{t}{n}$

**EXAMPLE:** The cacao bean lot is 12 tonnes and will be loaded in about 20 minutes. The samples can be obtained manually using a hand scoop with a capacity of 250g.

w = 2kg; s = 0.25kg; t = 20 minutes

- The required number of sampling points is 8 (using formula 1: 2kg/0.25kg per scoop = 8 sampling points).
- A sample needs to be taken every 2.5 minutes (using formula 2: 20 minutes/8 samples = 2.5 minutes)

**Figure 7.** Example of a calculation of sampling intervals for a lot in motion (Bioversity International, 2022).

2. Take the incremental samples across the whole section of the flow, perpendicular to the direction of the flow and at previously established time intervals (see example in Figure 7).
3. Start the time of sampling as soon as the hatches open and stop the time of sampling when the loading vessel is completely emptied or filled.
4. Collect all incremental samples into a clean storage vessel, such as a bucket with a lid (Annexes, Figure 46).
5. Carefully and thoroughly mix the incremental samples collected to form the composite sample.
6. Reduce the composite sample by following the instructions from step 11 of Section 5.4.2 'Sampling beans from bags'.

Taking incremental samples from still/static lots, wagons or vehicles:

1. Using Table 7 below, define the minimum number of sampling points in each wagon or vehicle.

**Table 7.** Minimum sampling points for taking incremental samples from a wagon or vehicle based on the amount of beans contained.

Amount of beans per wagon or vehicle (t)	Sampling points per wagon or vehicle
15 or less	5
15 to 30	9
more than 30	15

2. Assign the sampling points at locations corresponding to the middle of the wagons or vehicles and approximately 50cm from their outer sides.
3. At each sampling point, draw the incremental samples from three levels within the wagons or vehicles.
4. Collect all incremental samples into a clean storage vessel.
5. Carefully and thoroughly mix the incremental samples collected to form the composite sample.
6. Reduce the composite sample by following the instructions from step 11 of Section 5.4.2 'Sampling beans from bags':

Steps for taking incremental samples from still/static lots with shipping containers:

1. Each barge or ship should be sampled. If the samples cannot be obtained inside the barge or ship, the contents of the shipping container can be emptied first into a warehouse or storage location where the incremental samples can be drawn from.
2. The piles must be accessible on all sides and must not exceed 25t each.
3. The minimum number of sampling points is nine in each pile.
4. Draw the incremental samples from all side, and ensure that a sufficient number of beans is obtained from the centre (middle point from top to bottom) of the barge, ship or pile.
5. Collect all incremental samples into a clean storage vessel.
6. Carefully and thoroughly, mix the incremental samples collected to form the composite sample.
7. Reduce the composite sample by following the instructions from step 11 in Section 5.4.2 'Sampling beans from bags':

## 5.5 Documentation of data, calculations and results

Documenting accurate and detailed information of the sampling process is crucial for interpreting physical and sensory evaluation results, which provide inferences about the characteristics of the entire lot.

Every sample process must be accompanied by a unique sample ID assigned following the user's specific identification system that links the sample to a specific lot. The data to be recorded from the sampling process may include (but is not limited to) the following information:

- Sample ID.
- Weight (kg) of the sample.
- Sample origin.
- Sample producer.
- Date of sampling.
- Name of sample submitter.
- Name of sampler.
- Location where the sample was taken, e.g. warehouse.
- Types of analysis requested.
- Lot that the sample represents.

- Number of bags in the lot where the sample was taken.
- Number of reference samples.
- Size of reference samples.
- Mark/s of the original bag/s from which the sample was taken.
- Description of the bags (material, double bag, etc.).
- Number of sampling points.
- Notes about the external conditions of the bag/s from which the sample was taken.
- Sampling equipment used.
- If applicable, storage conditions of the sample (e.g. refrigeration at XX°C).
- Type of sampling method (i.e. bagged, bulk, stationary, moving stream).
- Dominant genetic origin or bean variety of the sample.
- Harvest period, i.e. main or mid-crop.
- Post-harvest conditions, i.e. fermentation and drying methods.
- Storage conditions, i.e. temperature, relative humidity, and use of pest control of the sample before reception.
- Bag or packaging conditions, e.g. material used for the sample at reception.
- If available:
  - » Grade of beans, e.g. A, B, C, or SS for substandard.
  - » Physicochemical data, e.g. moisture content.

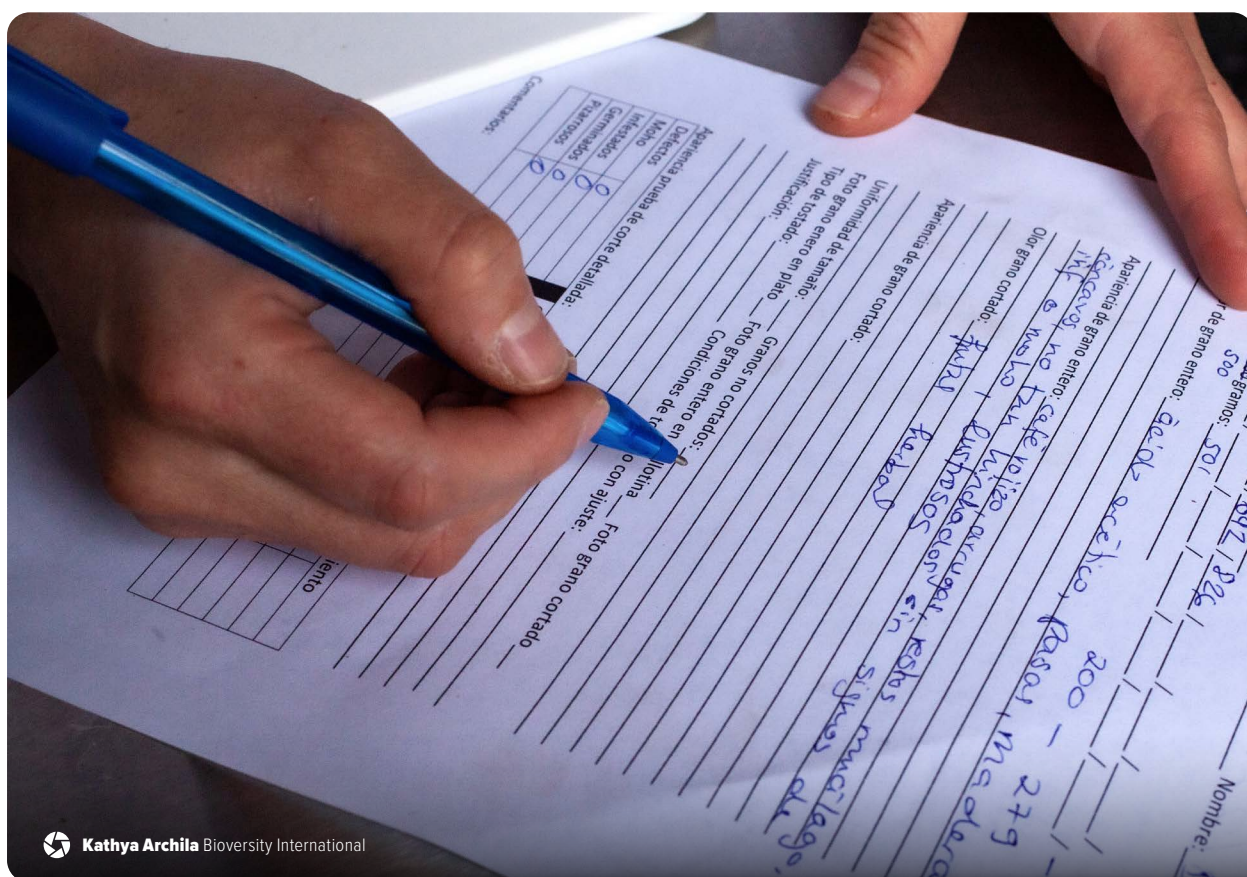


Table 8 below shows an example of the information that could be recorded on the lot, its provenance and/or place of origin and information on the post-harvest process. This information may vary according to specific needs and situations.

**Table 8.** Example of information to be recorded on a bean lot.

Sample number/ID	_____
Date of sampling (dd/mm/yyyy)	_____
Bag or container ID the samples were received in	_____
Country of origin of the cacao beans	_____
Sample owner's name (farmer)	_____
Farm location – address, city, village/town, country	_____
Processor (fermentation and drying)	_____
Date arrived (dd/mm/yyyy)	_____
Date fermented (mm/yyyy)	_____
Duration of fermentation (days)	_____
Method of fermentation	_____
Turning regime used etc.	_____
Dates of drying (dd/mm/yyyy)	_____
Drying method	_____
Sample identity and origin	_____
Sample storage conditions prior to receipt and before assessment	_____
Sampler's name	_____
Lot ID/Number	_____
Lot size (kg)	_____
Lot type (bags or bulk)	_____
Lot general condition	_____
Shipping marks (units x weight)	_____
Reference samples (units x weight)	_____
<b>Additional remarks:</b> condition of sample (visual, aroma, presence of waste, insects, mould, broken beans etc.)	_____





## PART B | PHYSICAL EVALUATION

### Chapter 6. **Introduction**

The physical evaluation of fermented and dried cacao samples serves as the initial step in assessing the quality and flavour of cacao. Producers and buyers attach great significance to these evaluations, focusing on indicators such as bean size, colour, moisture content, presence of contaminants, and signs of pests or diseases. Additionally, aroma assessments of both whole and cut beans are conducted during this stage.

This section provides a comprehensive protocol for determining the moisture content of cacao bean samples. It also includes the determination of bean size as a function of bean weight and bean count. It encompasses the assessment protocol for whole cacao beans, which aims to characterise the beans and identify any defects based on their outer surface. This is crucial for evaluating consistency in the physical quality of beans within a single batch or lot, as well as for making comparisons between different batches or lots.

Furthermore, this section covers the protocol for conducting cut tests, where whole beans are halved to examine their internal characteristics. These tests consider the colour, aroma, internal fissuring, and the presence of defects, all of which can affect the quality and flavour of the beans.

Additionally, this section provides details on the equipment, tools and materials required for the evaluations, the process for classifying cacao beans, and guidelines for documenting the results.

# Ch 7. Determination of moisture content

## 7.1 Objective

The objective of this protocol is to measure the moisture content of fermented, dried and unroasted cacao beans for subsequent processing.

It describes two methods: (1) the oven-drying method, which is the standard reference for calibrating alternative methods and (2) the method using a hand-held moisture meter (See Figure 8 for the comparison between the 2 methods).

Choosing a method depends on the needs and resources of the user. Both have advantages. The oven-drying method provides a direct measurement of the loss of water. The moisture meter is portable, allowing the user to carry out measurements from any location. However, in order to guarantee the accuracy and precision of the results, moisture meters must be calibrated and maintained periodically, e.g. once or twice a year.

The optimal range of moisture content for fermented and dried cacao beans is 6.5–7.5%. Moisture content below 6% can result in a shell that is too brittle and a greater likelihood that the beans disintegrate, leading to more broken beans. Moisture content above 8% results in the loss of edible material, and an increased risk of mould and bacterial growth, with potentially serious consequences for food safety, flavour and processing quality.

When conducting a flavour evaluation, determining the moisture content of cacao beans has two main purposes:

- Verifies that the sample is in the correct range for food safety, flavour and processing.
- Informs the determination of roasting conditions, allowing for more precise tailoring of roasting for each specific sample to express the beans' full flavour potential (see Chapter 11 'Roasting cacao beans').

## 7.2 Key specifications

**Table 9.** Key specification for the determination of moisture content.

Parameter	Specification
Minimum size of test sample of cacao beans	500g



## 7.3 Equipment, tools and materials

### Cacao beans

The minimum size of the test sample is 500g of cacao beans at room temperature (20–25°C/68–77°F), quartered from the reference sample, following the sampling process see Chapter 5 'Sampling bagged and bulk cacao beans'.

### Oven-drying method

- **Grinder:** For grinding beans into a coarse powder without heating (see Annexes, Figure 71 for examples).
- **Ventilated or forced air oven:** With temperature control at  $103\pm 2^{\circ}\text{C}$  ( $217\pm 3.6^{\circ}\text{F}$ ) see Annexes, Figure 48.
- **Heat-resistant metal or glass dishes:** Equipped with a lid for each sample (at least two), with a minimum useable surface area of  $35\text{cm}^2$  and a minimum diameter of 70mm and depth of 20–25mm (see Annexes, Figure 48).
- **Desiccator:** Large enough to contain all samples and can be sealed well, and filled with a dry desiccant (see Annexes, Figure 48).
- **Analytical measuring scale:** With a precision of 1mg.

### Moisture meter method

- **Moisture meter:** Calibrated for cacao beans with a moisture content ranging from 2% to 20%. Examples are shown in Annexes, Figure 49, Figure 50 and Figure 51

## 7.4 Procedure

### 7.4.1 Oven-drying method

The following steps outline the procedure for measuring moisture content using an oven:

1. Check that the desiccant in the desiccator is dry and has not changed colour. If it is not dry, or has changed colour (indicating wetness) dry it following the manufacturer's instructions for that specific desiccant material and brand.
2. Check that the dishes and lids are dried. If not, dry them overnight in the oven at  $110^{\circ}\text{C}$  ( $230^{\circ}\text{F}$ ) and store them in the desiccator until use.
3. Label the dishes and their lids clearly (e.g. A and B for the two test samples that are being measured).
4. Grind 500g of cacao beans into a coarse powder not exceeding a 5mm particle size (this size can be inspected visually). Avoid the formation of a paste as this can occur if the beans are ground too finely.
5. From the ground cacao beans, take at least two test samples (A and B) and follow steps 6–7 for each.
6. Weigh the empty dish with its lid and record its cacao mass as  $m_0$  ( $m_{0A}$  for test sample A and  $m_{0B}$  for test sample B).
7. Without setting the measuring scales to zero, quickly transfer 10g of the test sample into each of the dishes and cover them with their lids immediately. Record the total mass of each dish with the lid and the test sample as  $m_1$  ( $m_{1A}$  for test sample A and  $m_{1B}$  for test sample B).



**NOTE:** It is important to carry out the grinding and weighing (steps from 4 to 7) as quickly as possible, and within five minutes at most, to avoid any sample absorption or loss of moisture due to environmental conditions. When these two steps cannot be carried out immediately within the maximum timeframe indicated, the ground cacao beans will need to be stored in a plastic bag or air-tight container for a maximum of two hours.

8. Set the oven to  $103^{\circ}\text{C}\pm 2^{\circ}\text{C}$  ( $217^{\circ}\text{F}$ ).
9. Open the oven and place the dishes containing ground cacao beans on the rack. Remove the lids and place each open dish onto its corresponding lid. The test samples must dry uncovered.
10. Set the oven for  $16\text{h}\pm 1\text{h}$  at  $103^{\circ}\text{C}\pm 2^{\circ}\text{C}$  ( $217^{\circ}\text{F}$ ). Use an external timer if the oven does not have an inbuilt timer function for this length of time. Avoid opening the oven during this process. The measurement process may be carried out overnight, as 16 hours exceeds normal daily working hours.
11. When the 16<sup>th</sup> hour is reached, open the oven and cover the dishes with the lids before removing them from the oven.
12. Transfer the covered dishes to the desiccator and close or seal.



**NOTE:** To avoid moisture content variance due to environmental conditions, pay careful attention and open and close the desiccator as quickly as possible.

13. Leave the dishes inside the desiccator until the samples have cooled to room temperature ( $20\text{--}25^{\circ}\text{C}$  or  $68\text{--}77^{\circ}\text{F}$ ). This should take approximately 30–40 minutes.
14. To avoid moisture transfer, use tweezers to pick up the cooled dishes containing the sample and bring it to the scale for weighing. Record the mass as  $m_2$  ( $m_{2A}$  for sample A and  $m_{2B}$  for sample B).
15. Calculate the moisture content as a percentage of the initial mass, using the following formula (see Annex 3 for an example of calculation):

$$\text{moisture content} = (m_1 - m_2) \times \frac{100}{m_1 - m_0} \quad \text{where: } \begin{array}{l} m_0: \text{mass of empty dish with lid} \\ m_1: \text{mass of dish with lid and test sample before drying (g)} \\ m_2: \text{mass of dish with lid and test sample after drying (g)} \end{array}$$

16. Express the result as the mean of the moisture content of all test samples (test sample A, test sample B, etc).



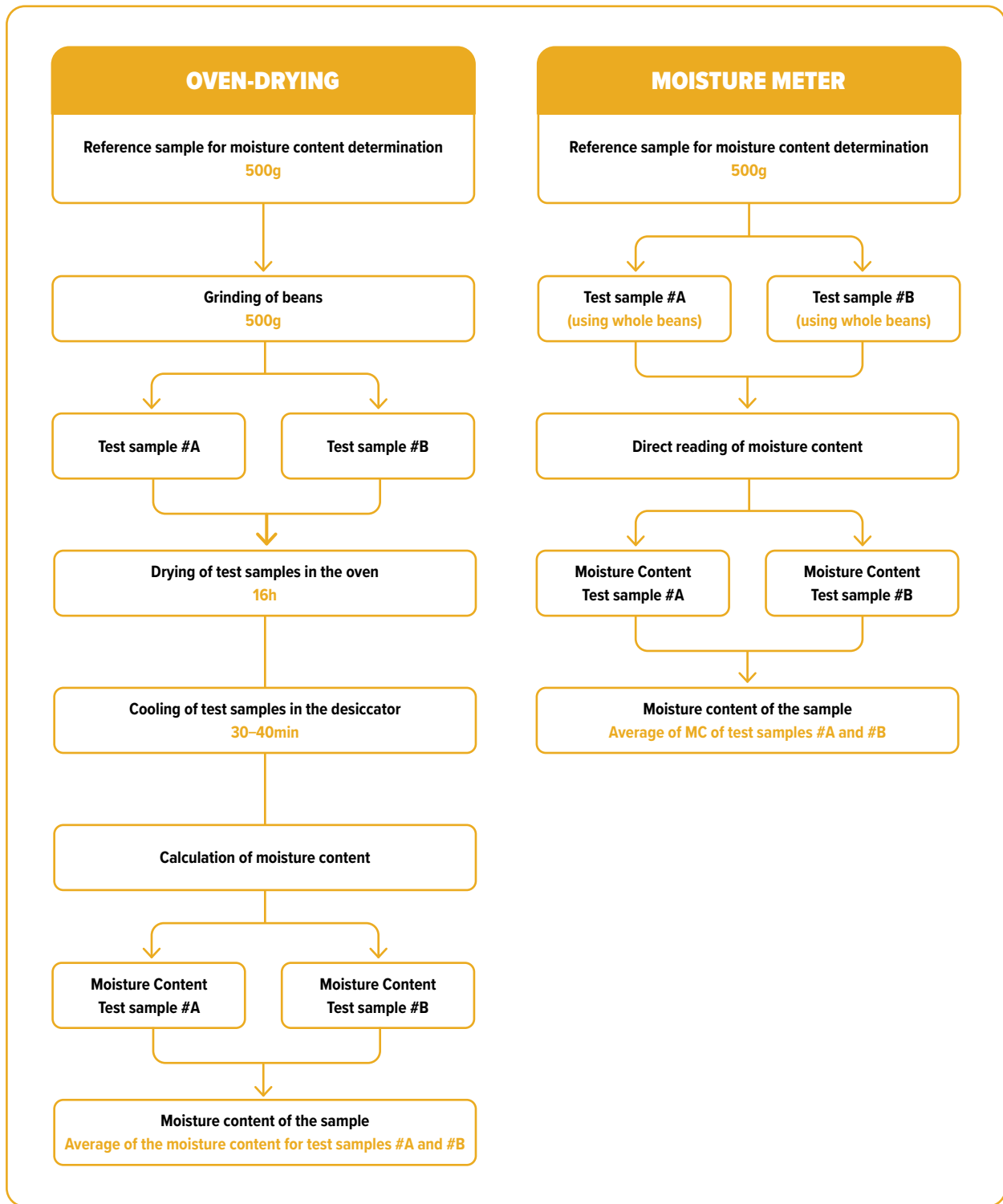
**NOTE:** The measurement is considered repeatable if the difference between two measurements (carried out simultaneously and by the same analyst) does not exceed a 0.3g/100g loss in mass.

## 7.4.2 Method using a moisture meter

This method uses a moisture meter. There are several equipment models and different brands that can be used. The choice depends on the users' preference and/or the given availability of commercial products.

The procedure consists of pouring the beans directly into the chamber or cup of the moisture meter. The portion size depends on the size of the chamber or cup as well as the beans, with smaller beans making a better fit for the cup. The measurements are taken in sequence and the result is the average of all the readings.

### 7.4.3 Comparison of methods



**Figure 8.** Comparison between oven-drying and moisture meter methods.

## 7.5 Documentation of data, calculations and results

Since moisture absorption, malabsorption and release are dynamic processes. Therefore, when recording data for moisture content determination, conditions such as ambient temperature and relative humidity in the testing area at that particular point in time, must be recorded.

The information to be documented for each bean sample is presented in Table 10 and Table 11 below, depending on the method used.

**Table 10.** Measurement of moisture content by oven-drying method.

Reference sample number/ID	_____	_____
Date processed (dd/mm/yyyy)	_____	_____
Total weight of the sample (g)	_____	_____
Grinder brand and model	_____	_____
Oven brand and model	_____	_____
Time drying starts (hh:mm)	_____	_____
Time drying ends (hh:mm)	_____	_____
Total drying time (hh:mm)	_____	_____
Drying temperature (°C or °F)	_____	_____
Room relative humidity (RH) at start	_____	_____
Room relative humidity (RH) at end	_____	_____
	<b>Test sample A</b>	<b>Test sample B</b>
Mass of the empty dish with lid- $m_0$ (g)	_____	_____
Mass of the dish with lid containing test sample <u>before</u> drying- $m_1$ (g)	_____	_____
Mass of the dish with lid containing test sample <u>after</u> drying- $m_2$ (g)	_____	_____
Moisture content (%) ( $m_1 - m_2$ ) (g)	_____	_____
<b>Comments</b>	_____	

**Table 11.** Measurement of moisture content using a moisture metre.

Reference sample number/ID	_____	_____
Date processed (dd/mm/yyyy)	_____	_____
Moisture meter brand and model	_____	_____
Amount of beans per measurement (g)	_____	_____
	<b>Test sample A</b>	<b>Test sample B</b>
Moisture content (%)	_____	_____
Average moisture content (%)	_____	_____
<b>Comments</b>	_____	

# Ch 8. Physical evaluation of whole cacao beans

## 8.1 Objective

This protocol describes the procedure for assessing the appearance and aroma of whole cacao beans through visual inspection and smell. It also describes the process of cleaning and sorting a given sample as a preparatory step for processing beans into cacao mass and chocolate for sensory evaluation. It includes procedures for the following:

- Describing the general external appearance.
- Describing the external aroma.
- Measuring the cleaning loss.
- Categorising foreign and cacao-related matter.
- Calculating the yield of clean, whole and well-formed cacao beans.
- Estimating the average size of the bean through the bean count and bean index.

The specific objectives of this protocol are to:

- Assess the overall external appearance and aroma of whole cacao beans to characterise the bean sample and identify serious defects.
- Measure and categorize the cleaning loss to calculate the clean bean yield.
- Obtain an indicator of cacao bean size by comparing it to the bean weight either through a cacao bean count per 100g or by calculating the average individual bean weight.

This protocol is important to assess the consistency of the physical quality of cacao beans within a single batch or lot, or between different batches or lots. For flavour evaluation, the physical evaluation of whole cacao beans aids in the following:

- Determining time and temperature adjustments for a basic roast, based on bean size and moisture content.
- Minimising damage to breaking and winnowing equipment resulting from abrasions, such as foreign matter including pebbles or stones.
- Increasing the efficiency of separating edible from non-edible portions of the beans, i.e., shells of cluster beans or shrivelled beans.
- Reducing risks of food safety by removing dust particles that harbour potentially pathogenic microorganisms and eliminating physical hazards (e.g., glass fragments).

## 8.2 Key specifications

**Table 12.** Key specifications for the physical evaluation of whole cacao beans.

Parameter	Specification
Minimum size of cacao bean test sample for sieving and calculating the cleaning loss	500g
Minimum size of cacao bean test sample for a bean count, appearance and aroma description	500g

## 8.3 Equipment, tools and materials

### Cacao beans

The minimum test sample size for sieving and determining the cleaning loss is 500g obtained from quartering the reference sample with a minimum of 2kg of beans (see Chapter 5 'Sampling bagged and bulk cacao beans').

Approximately 500g of cleaned and sorted beans is randomly selected for determining the bean count, describing the appearance and aroma..

### Tools for weighing

- Weighing scales – Electronic top-loading scales (Annexes, Figure 52), 2kg weighing capacity and 0.1g accuracy.
- Weighing trays.
- Hand-held scoop.

### Other tools

- Sieve with a mesh of 5mm size.
- Mechanical shaker can also be used.
- Camera for taking photos.
- Artificial light with an illumination of 800 to 1,000 lux if the natural is not sufficient.

## 8.4 Procedure

### 8.4.1 Determining the cleaning loss

Cleaning loss refers to the overall reduction in cacao bean sample weight resulting from the removal of small particles, such as dirt, through the process of sieving. It also includes the elimination of larger particles like stones, screws, flat beans, or clusters.

Sieving refers to the fine particles loss from the sample that pass through a 5mm mesh sieve. These cacao particle fines are typically dust present in the bag of the cacao beans..

The cleaning loss procedure is as follows:

1. Using a clean tray, weigh the cacao bean sample and record the total mass weight.
2. Pass the sample through a sieve with a mesh size of 5mm. A mechanical shaker can be used to ensure maximum separation of the sieving (particle fines).
3. Put the sieving away for weighing.
4. Transfer the remaining bean sample onto a flat tray, preferably with a white surface, to clearly see all the beans in one layer.
5. One by one, remove all cacao matter that contains nibs such as broken beans and bean fragments, bean clusters (clumped together and doubled), and infested beans showing insect damage.
6. Remove all foreign matters such as stones, wooden sticks, plastic pieces, glass, screws, and dry placenta.
7. Leave all clean, whole and well-formed beans on the tray. This is the clean and sorted sample.

8. Weigh it and calculate the yield of clean beans as a percentage of the total mass. The cleaning loss can be categorised by weighing each of the categories and calculating the percentage of each category in relation to the total mass of the sample.
9. Record the data of the original bean samples and of the resulting cleaned and sorted bean samples to calculate the yield (see Table 15).
10. Take photos of the cleaning loss under good natural or artificial light with an illumination of 800 to 1,000 lux for documentation purposes.

### 8.4.2 Determining the bean size

The procedure for calculating bean size is as follows:

1. Use at least 500g of the cleaned and sorted sample to determine the bean count.
2. Measure the weight of the mass of whole bean sample up to 0.1g. Record this as  $m_{WHOLE}$ .
3. Count the number of beans in the weighed sample. Record this as  $n_{WHOLE}$ .
4. Record the bean count ( $n_{BEAN}$ ) as the number of beans per 100g using the formula below:

$$\tilde{x} = \frac{m_{WHOLE}}{n_{WHOLE}}$$

5. Record the average bean weight ( $\tilde{x}$ ) using the formula below:

$$n_{BEAN} = \frac{n_{WHOLE}}{m_{WHOLE}} \times 100$$

6. Store the cleaned and sorted cacao bean sample in a clean food safe bag or container.
7. Throw away any remaining sample particles found in the tools used and on working surfaces.
8. Clean and sanitise all tools and work surfaces.
9. Visually examine the size homogeneity of the clean sample and leave a comment on your general impression of the sample.
10. Record the data (see Table 16).



**NOTE:** Bean size is an essential step towards determining the precise roasting conditions of a specific bean sample for sensory flavour evaluation (see Chapter 11 'Roasting cacao beans'). Additionally, beans can be classified based on a bean count as shown next in Table 13 and Table 14.

**Table 13.** Classification of beans by size based on bean count/100g (ISO 2451:2017). National regulations may differ.

Size code	Descriptive size classification	Bean count (100g)
1	Standard beans	<100
2	Mediums beans	101–110
3	Small beans	111–120
4	Very small beans	>120

**Table 14.** Example of grading allowances for cacao beans following a quality assessment (ICE, 2017). National grading systems may vary according to national laws or agreements with client.

Factors	Cacao bean grade		
	Outstanding	Satisfactory	Unacceptable
<b># of beans with defects</b> (per 100 beans)	0–5	6–15	>15
<b>% of residue and foreign material</b> (per 2kg sample)	–	1.30–3.75%	>3.75%
<b>Bean count – # of beans</b> (per 100g)	90–99	101–120	>120
<b>Standard deviation bean count</b> (per 2kg)	–	26–40	>40
<b>% of bean clusters</b> (per 2kg)	–	2.60–7.50%	>7.50%

### 8.4.3 Describing the appearance and aroma of whole cacao beans

Choose a location that is free of strong smells and pay particular attention to smells from perfumes, creams, deodorants, and hair products that may distort the aroma of the beans.

1. Place the 500g cleaned and sorted beans on a tray, bowl or plate.
2. Smell the beans at a distance of approximately 2cm.
3. Describe the odours and pay particular attention to identifying those that may indicate defects. Refer to Table 40 for a listing of off-flavours..
4. Visually examine the beans under natural daylight or equivalent artificial light with an illumination intensity of 800 to 1,000lux:
  - **Bean surface:** shrivelled or wrinkled, plump or plain, concave or convex, with or without stuck mucilage rests, clean or dirty. This is important because beans with shrivelled or wrinkled shells are not easily winnowed and will have higher processing losses due to shells sticking to the cotyledons or nibs. Meanwhile, fully plump beans will roast easily; their shells will come off more readily, thus requiring gentler breaking.
  - **Colour:** light or dark brown, tending toward orange or red, with or without spots, white, green or black spots. Off-colours can be due to heavy external mould and dark spots are often due to contact with metal.
  - **Signs of infestation:** presence of live and dead larvae, moulted larvae skins, webbing materials and insect droppings, which could pose a food safety risk and affect the flavour of the beans.
5. Take photos using natural daylight or artificial light with an illumination intensity of 800 to 1,000 lux. Document the appearance and aroma of the beans (see Table 17).

## 8.5 Documentation of data, calculations and results

**Table 15.** Data to be recorded for sieving, cleaning loss and yields of clean beans.

<b>Sample number/ID</b> _____	
Date processed (dd/mm/yyyy)	_____
Weight of the original cacao bean sample (g)	_____
Weight of the cleaned and sorted sample (g)	_____
Calculated cleaning loss (%)	_____
Calculated yield of clean whole and well-formed beans (%)	_____
.....	
<b>Categorisation of cleaning loss</b>	
<b>Sieving</b>	Weight (g) _____
	Percentage (%) _____
<b>Cacao-related matter</b>	Weight (g) _____
	Percentage (%) _____
<b>Foreign matter</b>	Weight (g) _____
	Percentage (%) _____

**Table 16.** Data to be recorded for the bean count and the average bean weight as indicators of bean size.

Sample number/ID	_____
Weight of the whole beans (g)	_____
Number of beans	_____
Calculated bean count (beans/100g)	_____
Calculated bean average weight (g/bean)	_____
Visual general impression of size homogeneity	_____

**Table 17.** Data to be recorded for the appearance and aroma of whole beans.

<b>Sample number/ID</b> _____	
<b>Parameter</b>	<b>Description</b>
<b>Appearance</b>	Bean surface _____
	Colour _____
	Signs of infestation _____
	Signs of mould _____
<b>Aroma</b>	Off-odours _____
	Dominant aroma attributes _____

# Ch 9. Physical evaluation of cut cacao beans

## 9.1 Objective

A cut test is performed on fermented and dried beans as the primary method for visually evaluating the physical quality of the beans, including colour, internal fissuring, and the presence of defects. Additionally, the aroma of cut beans is assessed. This information is essential for characterising the bean sample, confirming the genetic composition of the beans, and determining the optimal roasting conditions for processing the beans into cacao mass for sensory evaluation.

Results of the analyses described in this protocol may lead to the rejection of samples for further sensory analysis due to food-safety risks, if certain levels of defects are found. Such defects are characterised by: (1) extreme internal or external mould presence, (2) moth infestation or (3) high intensity of smoky odours. The experience of the person carrying out the cut test analysis is critical.

The cut test aroma gives a good initial indication of the dominant aromas that may be present in the cacao mass and/or chocolate. It also guides the selection of the roasting conditions.

This evaluation helps identify defective beans and excludes them from sensory evaluation due to food safety-related risks.

The objective is to assess a minimum of 50 and up to 300 beans, cut either using a knife and cutting board or a guillotine cutter, to expose equal halves that are quickly examined under good light before surface oxidation can occur. The use of a guillotine cutter allows the evaluator to immediately smell the aroma of 50 beans cut at the same time. If cutting beans individually, the use of protective gloves is an important precautionary measure requiring careful attention to avoid injuring hands and/or fingers.

All visual inspections (i.e., assessment of appearance and fissuring) must be carried out in daylight or with an equivalent artificial light of 800 to 1,000lux in illumination.

The location should be odourless, especially for the assessment of the aroma of cut beans. The bean and room temperature should be at minimum 22°C (71.5°F). If not, the beans will not release odour as they are poorly perceived in cold temperatures.

## 9.2 Key specifications

**Table 18.** Key specifications for the physical evaluation of cut cacao beans.

Parameter	Specification
Minimum number of cacao bean for the cut test	300 (ISO 2292:2017) – see note below

## 9.3 Equipment, tools and materials

### Cacao beans

A total of 300 cacao beans are to be taken randomly from the reference sample avoiding empty and flat beans (see Chapter 8 'Physical evaluation of whole cacao beans').



**NOTE:** All commercial contracts are governed by formal arbitration requirements that require that cut tests be conducted on up to 300 beans. Cut test can be repeated as many times as necessary to comply with legal and customer requirements. Companies tend to start with 50 beans. If those do not reveal any defects, no further cuts are made.

## Cacao beans

- For cutting individual beans:
  - » A knife, pruning shears or a plastic cutter with a fine edge are critical to ensure that the internal structure of the bean is not at all or minimally altered, to have an accurate view of the internal texture fissuring the beans (Annexes, Figure 54).
  - » Cutting board.
  - » Protective gloves.
  - » Classification board for cut beans (Annexes, Figure 55).
- A guillotine cutter for cutting 50 beans at once (Annexes, Figure 56f).
- Colour guide reference tool (Figure 35), for photographs of the cut beans.
- Cacao cut test chart (Annexes, Figure 33).
- Camera for photo capture.
- Artificial light of 800 to 1,000lux in illumination.
- Location that is odourless with a room temperature of 22°C (71.6°F), at minimum.

## 9.4 Procedure

### 9.4.1 Cutting the beans in halves

The procedures for cutting individual beans in half using a knife is as follows:

1. Randomly select the first set of 50 beans to cut, irrespective of size, shape and condition, from the test sample of 300 beans.
2. Wear protective gloves.
3. Use a knife, pruning shears or plastic cutter with a fine edge (Annexes, Figure 54) to cut each bean by holding it steadily to ensure an even cut lengthwise along the central longitudinal axis.
4. Immediately smell the bean and record your observations.
5. Put the two halves of the bean on the classification board (Annex 14.4, Figure 54).
6. Take photos using the colour guide reference and good natural light or artificial light of 800 to 1,000lux in illumination, within 15 minutes of cutting as colours will fade.
7. Record the observations in number and percentage for each category (defective beans, colour, fissuring, fermentation, mould, and insect infestation).
8. Repeat the process for all beans up to 300.
9. Take a random handful of the cut beans, smash them with your hands and smell them.
10. Record the description of the aroma.

The procedure for using the guillotine cutter for 50 beans at a time is as follows:

1. Open the guillotine and lay both sides horizontally on a table or on a flat and clean work surface.
2. Place a bean in each of the 50 chambers of the cutter on one side of the cutters. Select the beans randomly irrespective of size, shape and condition, from the test sample of 300 beans. Arrange the beans in such a way that the beans' longitudinal axis lines up with the longitudinal axis of the chamber in the cutting bed (Annexes, Figure 56a).

3. Close the top side of the guillotine cutter and press the latch firmly, to secure the closed cutter after filling with the beans (Annexes, Figure 56b and Figure 56c).
4. Place the cutter vertically on its feet on the floor or a low table (Annexes, Figure 56d).
5. Insert the guillotine blade to begin cutting. There is only one way that the blade can enter the cutting chamber, since one of the brass rails is larger than the other (Annexes, Figure 56d).
6. Apply careful, even pressure to cut the beans and create a smooth and even cut to ensure that the blade moves down the rails vertically, until it comes to a stop with the handle on the top of the cutting block (Annexes, Figure 56e). Applying uneven pressure can result in irregular bean breakage and a rough cut, which makes examination more difficult. Do not remove the cutting blade while the cutter is positioned vertically, to prevent the halves on the upper part from falling out of their guillotine chambers.
7. Lay the guillotine cutter flat on a table or on a flat and clean work surface (Annexes, Figure 56f); undo the latch and open the top part of the cutter (Annexes, Figure 56g).
8. Remove the blade (Annexes, Figure 56h).
9. Using a knife, manually cut any bean that remains uncut by the guillotine.
10. Take photos for your records using the colour guide reference and good natural light or artificial of 800 to 1,000lux in illumination within 15 minutes of cutting as colours will fade.
11. Record the observations by number and percentage for each category (defective beans, colour, fissuring, fermentation, mould, insect infestation, see Table 20).

#### 9.4.2 Describing the aroma

1. Immediately after cutting, assess the aroma by smelling the beans at a distance of 2cm from the nose, moving your head up and down the samples to perceive the overall smell.
2. Assess all aromas perceived, such as dominant, non-defective and defective odours, as listed in Table 40.
3. Record the perceived aroma using the form in Table 20. The perceived aromas are useful in selecting the most suitable roasting conditions for processing the beans into cacao mass for sensory evaluation (see Chapter 11 'Roasting cacao beans').

#### 9.4.3 Assessment of appearance defects, colour and fissuring

1. Visually examine both halves of each bean in daylight or equivalent artificial light of 800 to 1,000lux in illumination for the characteristics listed by group in Table 19.
2. Record your observations using the evaluation form in Table 20.
3. Assess each bean on the basis of defect level (Group 1), colour (Group 2) and fissuring (Group 3) detailed in Table 19.
4. Count the beans for each group, using the guide in Table 19.
  - a. **Group 1 – defective beans:** count how many beans are mouldy, insect-damaged, germinated and slaty: in descending order of severity. If a bean presents two or more defects, record the defect that is higher on this list. For example, if a bean is both mouldy and germinated, record the defect as mouldy, not germinated. Record the number of beans in each category.
  - b. **Group 2 – colour:** it takes about 15 minutes from the time the beans are cut before the colour starts to fade and change due to oxidation. Thus, photos should be taken within this time frame. In order to standardise colours for different lighting and camera

**Table 19.** Characteristics of internal appearance of beans by groups (based on Sukha, 2016; and Seguine, 2014).

<b>Group 1: defective beans</b>	<b>Group 2: colour</b>	<b>Group 3: fissuring</b>
Mouldy beans	<b>Low fermented</b>	Fissuring grade 1
Insect-damaged/infested beans	Fully purple/violet	Fissuring grade 2
Germinated beans	Ivory/white/blond	Fissuring grade 3
Slaty beans	<b>Partially fermented</b>	Fissuring grade 4
	Partly purple/violet	
	Partly brown	
	<b>Well fermented</b>	
	Light brown/yellowish	
	Fully light brown	
	Fully brown	
	<b>Over fermented</b>	
	Fully dark brown	
	Fully very dark brown	
	Fully black	

exposures, a reference guide for colour (see Annexes, Figure 35) may be used. Figure 33 and Figure 34 in the Annexes show coloured photos of cut beans that illustrate different degrees of fermentation. In general terms, purple/violet beans are less fermented than light to dark brown beans, while very dark brown or even black coloured beans indicate overfermentation. Record the number of beans in each category.

- c. Group 3 – fissuring:** fissuring is characterised by the opening up of large splits or rifts within the beans' internal structure as a result of proteolysis during fermentation which is retained during drying. Beans that are heavily fissured are generally more fermented than beans that have a cheesy or slaty appearance when cut. Record the number of beans in each category.

Fissuring and colour changes are two separate processes that occur during fermentation. While fissuring grade and colour are related, they are not always correlated and may depend on the beans' genetic traits and post-harvest conditions, when fermented and dried. When used alone, neither a fissuring grade, nor colour can provide complete information about the degree of fermentation, hence a comprehensive analysis that includes all observations about bean appearance is recommended.

Judgement is required in interpreting cut tests. The cut test and the flavour profile are important to assess the level of fermentation. A cut test is indicative and does not predict the results of a flavour evaluation.

## 9.5 Classification of cacao beans

Various standards for evaluating the physical quality of cacao beans and grading methods rely on the qualitative and quantitative assessment of specific criteria, primarily determined through the cut test. These evaluation criteria include:

- **Defects:** Assessing the appearance of beans, such as the presence of mouldy, germinated, or insect-damaged beans.
- **Sensory attributes:** Evaluating the aroma of the beans, including detecting smoky, mouldy, or hammy odours.
- **Degree of fermentation:** Examining the colour and fissuring of the cut beans' surface to determine the level of fermentation, distinguishing between smooth or fissured surfaces.

Different grades and categories for classifying cacao beans are set by the International Organization for Standardization (ISO), the Cocoa Merchants' Association of America (CMAA), the Federation of Cocoa Commerce London (FCC), the U.S. Food and Drug Administration (FDA), the ASEAN Ministers on Agriculture and Forestry (AMAF) and others, based on the percentage of defects and/or level of fermentation (Annexes, Table 47). National regulations on cacao bean grading vary among countries – see compilation in Annexes, Table 48.



## 9.6 Documentation of data, calculations and results

**Table 20.** Form to record the appearance and aroma of cut beans. It is recommended 50 should be described.

<b>Sample number/ID</b> _____								
<b>Aroma</b>								
Aroma description _____								
<b>Appearance</b>								
Description on the overall appearance of cut beans _____								
<b>Defective beans</b>								
		<b>Number of beans</b>						
	<b>DEFECT</b>	<b>Cut 1</b>	<b>Cut 2</b>	<b>Cut 3</b>	<b>Cut 4</b>	<b>Cut 5</b>	<b>Cut 6</b>	<b>Total%</b>
	Mouldy	_____	_____	_____	_____	_____	_____	_____
	Insect-damaged/infested	_____	_____	_____	_____	_____	_____	_____
	Germinated	_____	_____	_____	_____	_____	_____	_____
	Slaty	_____	_____	_____	_____	_____	_____	_____
	<b>Total</b>	_____	_____	_____	_____	_____	_____	<b>100%</b>
<b>Colour</b>								
		<b>Number of beans</b>						
	<b>CATEGORY</b>	<b>Cut 1</b>	<b>Cut 2</b>	<b>Cut 3</b>	<b>Cut 4</b>	<b>Cut 5</b>	<b>Cut 6</b>	<b>Total%</b>
↑ - ↓ <b>FERMENTATION</b> + ↓	Fully purple/violet	_____	_____	_____	_____	_____	_____	_____
	Ivory/white/blond	_____	_____	_____	_____	_____	_____	_____
	Partly purple/violet	_____	_____	_____	_____	_____	_____	_____
	Partly brown	_____	_____	_____	_____	_____	_____	_____
	Light brown/yellowish	_____	_____	_____	_____	_____	_____	_____
	Fully light brown	_____	_____	_____	_____	_____	_____	_____
	Fully brown	_____	_____	_____	_____	_____	_____	_____
	Fully dark brown	_____	_____	_____	_____	_____	_____	_____
	Fully very dark brown	_____	_____	_____	_____	_____	_____	_____
	Fully black	_____	_____	_____	_____	_____	_____	_____
		<b>Total</b>	_____	_____	_____	_____	_____	_____
<b>Fissuring grade</b>								
		<b>Number of beans</b>						
	<b>FISSURING GRADE</b>	<b>Cut 1</b>	<b>Cut 2</b>	<b>Cut 3</b>	<b>Cut 4</b>	<b>Cut 5</b>	<b>Cut 6</b>	<b>Total%</b>
	1	_____	_____	_____	_____	_____	_____	_____
	2	_____	_____	_____	_____	_____	_____	_____
	3	_____	_____	_____	_____	_____	_____	_____
	4	_____	_____	_____	_____	_____	_____	_____
	<b>Total</b>	_____	_____	_____	_____	_____	_____	<b>100%</b>
<b>Comments</b> _____								



## PART C | PROCESSING CACAO BEAN SAMPLES

### Chapter 10. **Introduction**

The objective of processing fermented and dried cacao beans into mass and chocolate is to carry out the sensory evaluation and describe their flavour profile and determine their global quality.

This section provides protocols for various stages of processing cacao beans samples from roasting, breaking and winnowing, to processing the cacao nibs into mass and dark chocolate.

After analysing the bean samples for physical qualities such as moisture content, bean size, and cut test aroma, precise roasting temperatures and time can be determined for each sample optimal flavour expression. The resulting cacao nibs are then ground into a fine cacao mass and chocolate for sensory evaluation.

# Ch 11. Roasting cacao beans

## 11.1 Objective

This protocol describes the roasting process for fermented and dried cacao beans. It is developed through extensive experience in roasting cacao beans from all regions and cacao-producing countries worldwide, representing a broad range of genetic diversity and flavour profiles resulting from post-harvest practices. The goal of determining the optimal roasting conditions is to ensure the optimal flavour expression of each cacao bean. The basic roasting time and temperature are selected based on the dominant genetics, and adjusted based on the bean size and moisture content.

Once roasted the beans can be broken and winnowed and further processed into mass and chocolate for subsequent sensory evaluation. For this purpose, cacao beans samples are roasted only once. Therefore the optimal roasting conditions must be selected carefully. Bean-to-bar chocolate makers will typically conduct multiple roasts to determine their desired flavour profile for the final product they intend to create. This protocol provides guidance on selecting the most appropriate roasting conditions when conducting a single roast.

The procedure detailed in this protocol specifically applies to the use of a forced air convection oven equipped with precise temperature and time controls, to ensure accuracy and reproducibility in the roasting process.

It is important to note that the roasting conditions outlined in this protocol may not eliminate microbiological hazards, as it ultimately depends on the initial microbiological load present in the unroasted beans. It is the responsibility of the user to implement additional controls and perform microbiological analyses to ensure food safety when processing samples into mass or chocolate to be consumed by panel members for sensory evaluation.

## 11.2 Key specifications

**Table 21.** Key specifications for roasting cacao beans.

Parameter	Specification
Minimum size of cacao bean test sample	600g
Type of oven	Forced-air convection oven, specifications in Tables 60 and 61 Oven trays with the mesh – see Section 11.3.2 'Oven trays'
Basic roast: temperature and time	<b>Low roast:</b> 112°C (234°F) x 25min <b>Medium roast:</b> 120°C (248°F) x 25min <b>High roast:</b> 130°C (266°F) x 25min
Adjustments to roasting temperature and time	Based on bean size and moisture content (see Annexes, Table 49)

## 11.3 Equipment, tools and materials

### Cacao beans

The minimum test sample is of 600g of cleaned and sorted, cacao beans representing a lot. The amount of cacao beans must be enough to cover each oven tray with a single layer (see Section 11.4.2 'Loading the beans on the oven trays'). This can be between 600–800g with the use of 2 trays per roasting. If the targeted amount of cacao mass is greater, the roasting process is repeated until the full sample is roasted.

#### 11.3.1 Roasting oven

The procedure is for the use with a forced air convection oven with the minimum recommended specifications provided in Table 22.

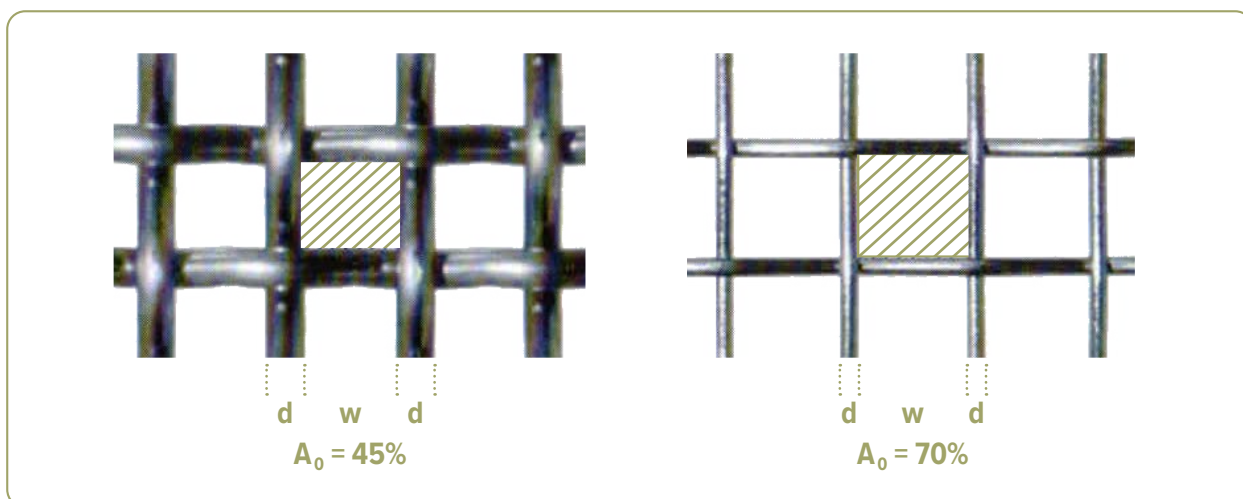
**Table 22.** Recommended specifications for the roasting oven.

Parameter	Specification
Type	Forced air convection oven
Variables to control	Temperature and time (digital setting)
Temperature range	100–200°C (212–392°F)
Recovery time after 30s of opening the door at 150°C (302°F) in empty oven	Less than 5 min
Temperature uniformity within the oven at 150°C (302°F)	Variation of $\pm 2^{\circ}\text{C}$ ( $\pm 3.6^{\circ}\text{F}$ )
Temperature stability (over time) within the oven at 150°C (302°F)	Fluctuation of $\pm 0.3^{\circ}\text{C}$ ( $\pm 0.6^{\circ}\text{F}$ )
Speed of temperature increase (from ambient temperature to 150°C/302°F, empty oven)	6°C (10.8°F) per minute maximum
Venting	Closed
Air circulation rate	80 chamber-air exchanges/hour
Number of trays	2
Position of trays	Symmetrically placed above and below the fan opening
Compliance	Food grade, national and local regulations



### 11.3.2 Oven trays

- It is recommended to use two oven trays covered with a wire mesh screen from food-safe materials, preferably stainless steel. However, regular steel can be used as an alternative (refer to Annexes, Figure 58 and Figure 59). It is important to avoid using zinc-coated or treated steel wire mesh screens due to their potential toxicity at high temperatures and their reactivity with the acidity of the beans.
- To minimise contact between the beans and the surface of the oven tray, it is advisable to use trays with thin-wired mesh screens. This helps prevent excessive heat transfer to the beans through conduction. Examples of mesh screens are detailed in Figure 60 of the Annexes. For square wire mesh standard specifications, refer to Table 62 of the Annexes.
- It is recommended to ensure that the screen open area between each steel wire thread, which forms the mesh, is greater than 75% of the total surface area of the tray. The screen open area refers to the percentage of the mesh opening in relation to the entire screen surface and is determined by the ratio between the mesh width (w) and wire diameter (d) (refer to Figure 9).
- Avoid using metal plates or trays with holes, as they do not provide sufficient screen open area. These plates or trays can lead to uneven roasting due to conduction where the metal comes into contact with the beans.



**Figure 9.** The open area of a screen ( $A_0$ ) defines the mesh openings as a percentage of the entire screen surface and is based on the ratio between mesh width (w), assuming the space is square, and the wire diameter (d). ([metalmesh.com.au/glossary](http://metalmesh.com.au/glossary))

$$A_0 = \frac{(w \text{ (mm)})^2}{(w \text{ (mm)} + d \text{ (mm)})^2} \times 100\%$$

- In cases where filler beans are used, use thin stainless-steel or aluminium dividers to separate the two types of beans.

### 11.3.3 Filler beans

- If there are not enough cacao beans to fill both oven trays, filler beans should be used.
- Filler beans should have the following characteristics:
  - » Free of defects and off-flavours (see Chapter 9 'Physical evaluation of cut cacao beans'), to avoid the transfer of extraneous odours to the reference bean sample.
  - » Neutral in flavour, with a flavour profile similar to the reference (if known) to ensure that the roasting of filler beans does not impart strong odours to the reference bean sample.

- » Match the reference bean sample in terms of dominant genetics, bean count, and moisture content. This is necessary to avoid any transfer of over-roasted flavours to the reference bean sample. While under-roasted notes are of less concern and are less likely to be transferred, it is still important to ensure consistency in the roasting conditions for the filler beans.

### 11.3.4 Other tools

- A top-loading digital scale with a minimum capacity of 400g and precision of 1g for weighing the beans.
- A digital timer in addition to the one provided by the oven.
- Heat-resistant mitts for safely handling, loading and removing the roasting trays.
- Heat-resistant, food-grade containers for weighing the beans and transferring them from the scale to the roasting trays.
- A heat-resistant stand to allow the roasting trays to cool or alternatively a separate tray to place the freshly roasted beans for cooling.
- A brush for cleaning the oven.
- A non-contact infrared thermometer with a measuring range of 0–100°C (32–212°F) to measure the temperature of the beans during the cooling process, prior to breaking and winnowing.

## 11.4 Procedure

### 11.4.1 Selecting the roasting conditions

The specific roasting temperature and time are determined based on available information from the samples and/or verification by experts regarding the dominant genetics of the samples (whether leaning towards Criollo, Trinitario or Forastero type). Additionally, the physical analysis of both whole and cut beans, as well as the aroma, serve as indicators of the genetic characteristics described in Chapters 8 and 9. It is important to ensure that the bean sample is clean and sorted, removing damaged beans (such as those with missing shells, germinated, obvious defects, or cuts), extraneous matter, and small or flat beans.

The selection of the basic roast (low, medium, or high roast), must be done carefully to optimise the expression of the inherent flavour characteristics. For example, a high roast may enhance the development of intense cacao flavours in Forastero types, while it could result in the loss of delicate flavour notes (e.g., floral, fruity) in Trinitario and Criollo types. According to the basic roasting conditions, further adjustments are made based on bean size and moisture content. These adjustments account for differences in heat transfer, which in turn influence flavour development.

1. To determine the appropriate basic roasting conditions in Table 23, the following factors should be taken into account:
  - Dominant genetic type (if known).
  - Physical appearance of the whole and cut beans, including their colour, which can indicate the genetic type or degree of fermentation.
  - The aroma from the cut test (refer to Section 9.4.2 'Describing the aroma'), which is indicative of the flavour notes that could be expressed.
  - The necessary adjustments of time and temperature are based on the bean size and moisture content. Refer to Table 49 in the Annexes.
  - If the aroma notes of the unroasted beans are not clearly perceived or identified, it is recommended

to conduct roasting trials using at least two different roast types (refer to Table 23).

- It is crucial to document and communicate the selected roasting conditions (time and temperature), along with relevant sensory evaluation data (see the form in Section 11.5 Table 24).

**Table 23.** Basic roasting conditions, including temperature and time, are determined based on the aromas identified in the cut test and the dominant genetic type of the cacao beans (if known).

Basic roast	Temperature	Time (minutes)	Cacao bean aroma from cut test and information on genetic types
Low	112°C (234°F)	25	Significant, nutty or caramel notes are perceived. This roast may be best suited for some Criollo types
Medium	120°C (248°F)	25	Significant fresh fruity, browned fruits, spicy or floral notes are perceived. This roast may be best suited for some Trinitario types
High	130°C (266°F)	25	None of the above notes are significantly perceived. At these roasting conditions, cacao notes will be enhanced. This roast may be best suited for some Forastero types

#### 11.4.2 Loading the beans on the oven trays

1. Clean the oven wire mesh trays thoroughly using a suitable brush before loading them.
2. Load each tray with a single layer of beans. For each roasting session, prepare a maximum of two trays.
3. Weigh the beans (in grams) and make sure to record the data.
4. If there are insufficient beans to completely cover the two trays, fill the empty surface with filler beans. Use dividers to keep the filler beans separate. Refer to Section 11.3.3 on 'Filler beans' for more information.
5. Put both trays below and above the air fans at equal distance.



**NOTE:** The oven load significantly affects the roasting results, making it crucial to ensure that both trays are covered precisely with a single layer of beans, each with the same weight.

#### 11.4.3 Roasting process

1. Turn on the oven and set the desired roasting temperature as determined in Procedure 11.4.1 'Selecting the roasting conditions' step 2.
2. Keep the two loaded trays close to the oven, ready for quick loading as soon as the oven reaches the target temperature.
3. Set the timer for 20 seconds, which is the maximum time for opening and closing the oven to minimise temperature drop.
4. Once the oven reaches the desired temperature, start the timer, open the oven door, place the two trays inside, and promptly close the oven door. Position the trays as symmetrically as possible, with one tray above and the other below the circulating fan. Optionally, take note of the lowest temperature reached after closing the door, which indicates the temperature drop.

5. When the temperature reaches 2°C (3.6°F) below the target roasting temperature, start the timer for the targeted roasting time.
6. When the targeted roasting time is reached, open the oven door, remove the two trays and place them on a heat-resistant clean surface.
7. Load two additional trays if necessary to complete the roasting of a specific sample. Ensure that the removal and loading process does not exceed 20 seconds. Repeat this process until the roasting of the sample is completed.



**NOTE:** Any recommendations in roasting times are based on careful control in the laboratory. This ensures that recovery times for oven temperatures after loading the roasting trays are kept as constant as possible. Ovens different from the specified type, including their recovery times, can still be used. Nevertheless, experience and experiments may be needed to adjust the start of the roasting time, as uniform temperature throughout the oven is critical.

#### 11.4.4 Cooling the beans and moisture content

1. Cool the beans on the trays kept at room temperature, away from anything that has a strong smell. If available, use a cooling tray (see Annexes, Figure 61).
2. The beans are considered ready for breaking and winnowing when their temperature is approximately 40°C (104°F), which can be measured using an infrared thermometer or sensed as barely warm to the touch. The time it takes for the beans to reach this temperature can vary, depending on the room temperature and ventilation, typically taking about 10 minutes.
3. After roasting, weigh the beans and record the data.
4. It is recommended to break and winnow the roasted beans within 60 minutes after roasting. This timeframe facilitates easier separation of the shells from the nibs.
5. In certain processing scenarios, knowing the moisture content of the beans after roasting can be useful. For instructions on how to measure the moisture content, refer to Section 7.4.1 'Oven-drying method'. On average, there is a 4% moisture loss during roasting.



**NOTE:** Unroasted beans are a raw agricultural product that may contain pathogens prior to roasting and can cross-contaminate the roasted beans if there is no clear separation of processes. Clean and disinfect all counter space, contact surfaces and tools between batches and samples. See Part A, Chapter 3 for additional recommendations.



## 11.5 Documentation of data, calculations and results

**Table 24.** Data to be recorded for the roasting process and roasting results.

<b>General</b>	
Reference sample number/ID	_____
Date (dd/mm/yyyy)	_____
Name of the person carrying out the roasting process	_____
<b>Oven</b>	
Brand	_____
Model	_____
Type	_____
Year	_____
<b>Trays</b>	
Material	_____
Wire mesh screen open area (%)	_____
Thickness of the wire mesh screen (mm)	_____
Number of trays used	_____
<b>Weight of the beans before roasting (g)</b>	_____
	_____
<b>Weight of beans per tray (g)</b>	_____
	_____
<b>Basic roasting conditions</b>	
LOW	112°C (234°F) 25min _____
MEDIUM	120°C (248°F) 25min _____
HIGH	130°C (266°F) 25min _____
<b>Moisture content (%)</b>	_____
<b>Bean size (g)</b>	_____
<b>Adjusted roasting conditions</b>	
Temperature (°C or °F)	_____
Time (min)	_____
<b>Weight of the beans after roasting (g)</b>	_____
	_____
<b>Moisture content after roasting (%)</b>	_____
	_____
<b>Additional information</b>	_____
	_____

## Ch 12. Breaking and winnowing cacao beans

### 12.1 Objective

This protocol outlines the process of breaking and winnowing roasted cacao beans to obtain the nibs, which are then grounded into a mass and chocolate for sensory evaluation.

Breaking the roasted beans reduce their size and loosen the shells from the nibs or cotyledons. Winnowing aims to separate the shells from the nibs. To facilitate the separation of shells from the nibs, it is recommended to break and winnow the roasted beans within 60 minutes after roasting. The process of breaking and winnowing roasted beans can be carried out using manual, semi-manual, or electro-mechanical systems. It is crucial to handle the beans carefully during the breaking process to avoid generating fines and dust.

Once the broken roasted beans have been winnowed, the visual inspection should indicate that there is no remaining cacao shell in the nibs. This is essential to reduce the risk of equipment damage and ensure health safety, as the shells may contain pathogens that are not eliminated during the roasting process. Cacao shells are fibrous and hard, and they may also carry abrasive silicate materials on their exteriors. Their presence during grinding into mass and chocolate, can lead to equipment abrasion and negative impacts on flavour. According to the Codex Alimentarius (Codex Stan 141-1983, revised 2001 amended 2014), the acceptable maximum shell content in cacao mass is 1.75%. Although this cannot be measured analytically with a scale, the goal is to eliminate all shells based on visual inspection, ensuring that there are less than 0.1% of shell fines in the nibs.

The exterior of the cacao shells may retain non-pathogenic thermophilic bacterial spores that survive the roasting process. By completely removing shells and shell fragments through visual inspection, Cacao of Excellence data shows that thermophilic microorganisms counts are far below 10,000/g with an average of around 100/g.

Inefficient winnowing can result in a significant loss of small nib particles, which can have a considerable economic impact, particularly when dealing with large volumes of beans. Depending on the sample, some shells may remain stuck to the nibs and not separate during the winnowing process. These remaining shells must be manually removed (picked) using tweezers.

It is important to note that breaking and winnowing should not be conducted in close proximity to unroasted cacao beans. Additionally, it is recommended to calculate the yield of nibs obtained from the roasted beans once the shells are completely removed, to estimate the quantity of cacao mass to be produced.

### 12.2 Key specifications

**Table 25.** Key specifications for breaking and winnowing cacao beans.

	Parameter	Specification
	Minimum size of test sample of roasted cacao beans for representativeness of a bean lot	600g
	Target for the shell-to-nib ratio – visually	0%

## 12.3 Equipment, tools and materials

### Cacao beans

The output of the roasting process of a minimum of 600g of cacao beans, representing a bean lot. This quantity can be increased based on equipment capacity and/or for a greater quantity of cacao mass and chocolate for sensory evaluation.

#### 12.3.1 Manual and semi-manual processes

##### Recommended tools for a manual process

- 3 trays or bowls to collect shells and nibs separately.
- Tight-fitting rubber gloves.

##### Recommended tools for a semi-manual process

- Zip-type, resealable plastic bags, heavy gauge ( $\geq 3\text{mm}$ ) (Annexes, Figure 62a).
- A rolling pin (Annexes, Figure 62a).
- A flat tray of a suitable size, depending on the amounts roasted.
- At least 1 tray or bowl to collect the shells and nibs separately.

##### Recommended winnowing tools options

- A hair dryer or ventilator (Annexes, Figure 62b).
- A winnowing basket.
- A self-made winnower (Annexes, Figure 63).

#### 12.3.2 Electro-mechanical process

A cacao bean breaker and winnower are required. The following are examples of commercial brands available:

- CAPCO cacao bean cracker and winnower (Annexes, Figure 64).
- CocoaTown™ cacao bean cracker (Annexes, Figure 65) and winnower (Annexes, Figure 66).
- At least 2 trays or bowls to collect shells and nibs separately.

#### 12.3.3 Recommended tools for picking shells from the nibs

- A stainless steel tray.
- Tweezers for picking the nibs with stuck shells.
- A bowl for collecting the nibs with stuck shells.
- Eye protection.
- Ear protection during mechanical procedures.

## 12.4 Procedure

### 12.4.1 Manual process

1. Wear tight-fitting rubber gloves from start to finish.
2. Fill a clean tray or bowl with the roasted cacao beans and have two empty clean trays or bowls within close proximity to collect the nibs and shells separately.
3. Break the beans individually between your fingers and the shells to obtain the nibs.
4. Collect the nibs and shells in separate trays or bowls.

5. Use a pair of tweezers to remove the shell fragments, if shell fragments remain among the nibs, and if the shell is stuck on the nib, discard the nib.
6. Discard the shells.
7. Inspect visually to ensure that there are no shells with the nibs.
8. Record the weight of the nibs.
9. Store the nibs until further use (see Section 12.4.6 'Storage of cacao nibs').
10. Between batches, clean and disinfect the counters, contact surfaces and tools, using a food-grade and odourless cleaning agent or disinfectant as described in Chapter 3 on 'Food safety considerations'.

## 12.4.2 Semi-manual process

### Breaking

1. Fill from third to a half of a new resealable zip-type bag with roasted cacao beans.
2. Place the bag on a flat surface.
3. Apply pressure by running a rolling pin over the beans to beak them (Annexes, Figure 62a).
4. Flip the bag on the other side and run the rolling pin over the beans once more, making sure to beak all remaining whole beans.



**NOTE:** It is recommended to use a new resealable zip-type bag for each sample or for the same sample, especially when the bag becomes punctured.

### Winnowing

Wind-winnowing or using a hair dryer or ventilator can create a mess. It is advisable to perform these processes in a protected outdoor area to ensure that the shells are blown away and not dispersed indoors.

The wind-winnowing technique is as follows:

1. Transfer the broken beans with shells into a tray or a winnowing basket.
2. Hold the container with both hands on one side, toss the broken beans and shells into the air, and allow them to fall back into the tray.
3. While tossing, allow the wind to carry the lighter shells away. If there is no wind stream, use a ventilator to blow the shells in one direction.
4. The wind-winnowing technique may not completely remove all shells. Therefore, use a pair of tweezers to remove these shells completely. Pay special attention to shells that remain attached to the nibs and remove them.
5. Collect the winnowed nibs in a separate container.
6. Record the weight of the nibs.
7. Discard the shells.
8. Store the nibs until further use (see Section 12.4.6 'Storage of cacao nibs').

The hair-dryer technique is as follows:

1. Transfer the broken beans with shells onto a flat tray in a well-ventilated area.
2. Set the hair-dryer at the coolest temperature or no-heat setting.

3. Hold the hair-dryer at a 30–45° angle at a distance of ≥15cm from the tray.
4. Gently, move the hair-dryer nozzle along the tray to maximize winnowing and remove as many shells as possible, lightly tossing the broken material in the tray to expose it to the air stream.
5. Gradually increase the speed setting of the hair dryer, particularly towards the end of the process when larger shells are still present.
6. Using the hair dryer for winnowing will not completely remove all shells. Use a pair of tweezers to remove the remaining shells completely. Pay special attention to shells that remain attached to the nibs and remove them.
7. Collect the winnowed nibs in a separate container.
8. Record the weight of the nibs.
9. Discard the shells.
10. Store the nibs until further use (see Section 12.4.6 'Storage of cacao nibs').

Use of a self-made winnower with a vacuum cleaner and a ventilator (Annexes, Figure 63) is as follows:

1. Switch on the vacuum cleaner.
2. Feed the broken beans into the inlet hopper.
3. Switch on the ventilator and control the speed (high or low) as needed.
4. Repeat the process as many times as needed to remove all shells.
5. Inspect the outgoing nibs for the presence of shells.
6. Use a pair of tweezers to remove the remaining shells completely. Pay special attention to shells that remain attached to the nibs and remove them.
7. Collect the winnowed nibs in a separate container.
8. Record the weight of the nibs.
9. Discard the shells.
10. Store the nibs until further use (see Section 12.4.6).
11. Between batches, clean and disinfect the counters, contact surfaces and tools, using a food-grade and odourless cleaning agent or disinfectant as described in Chapter 3 on 'Food safety considerations'.

### 12.4.3 Electro-mechanical process

The procedure for breaking and winnowing cacao beans using electrical machines may vary depending on the given equipment's type and model. It is best to consult the manual. The general steps for using electrical machines are presented below. Images, specifications, and procedure for two brands are detailed in Annexes, Figure 64, Figure 65, Figure 66 and Annexes, Table 64 and Table 65.

#### Breaking

1. Verify the readiness of the equipment for use, ensuring that it is clean and that all its components are properly assembled.
2. Turn on the breaker.
3. Feed the cacao beans into the inlet hopper of the breaker.
4. Tailor the speed setting (if applicable to the equipment) of the impact breaker according to the desired size of the broken or cracked beans.
5. Collect the broken beans and place into a clean container.
6. Turn off the breaker.

## Winnowing

1. Verify the readiness of the equipment for use, ensuring that it is clean and that all its components are properly assembled.
2. Turn on the winnower.
3. Gradually introduce the broken beans into the sieving and vacuum section of the winnower.
4. Adjust the vacuum (aspiration) setting (if applicable to the equipment) of the winnower based on the size and/or density variations within the broken beans. For instance, select a higher aspiration setting for large nibs.
5. Collect the winnowed nibs in a separate container.
6. Discard the shells.
7. Use a pair of tweezers to remove the remaining shells completely. Pay special attention to shells that remain attached to the nibs and remove them.
8. Combine the nibs collected in step 5.
9. Turn the equipment off.
10. Record the weight of the nibs.
11. Store the nibs until further use (see Section 12.4.6).
12. Between batches, clean and disinfect the counters, contact surfaces and tools, using a food-grade and odourless cleaning agent or disinfectant as described in Chapter 3 on 'Food safety considerations'.

### 12.4.4 Calculation of the yield of nibs

Calculating the yield of nibs obtained from the roasted beans is crucial in estimating the quantity of cacao mass that can be processed. The formula is presented in Figure 10, below.

$$\text{Yield} = \frac{\text{Weight of the nibs free of shells (g)}}{\text{Weight of roasted cacao bean (g)}} \times 100$$

**Figure 10.** Formula for calculating the yield of cacao nibs from roasted beans.

### 12.4.5 Considerations for breaking and winnowing unroasted cacao beans

When breaking and winnowing unroasted cacao beans, it is imperative to adhere to additional food safety measures to prevent the contamination of nibs by pathogens. Some of the recommended measures include, but are not limited to, the following:

- Ensure beans are thoroughly cleaned before breaking and winnowing.
- Follow the steps indicated in Chapter 8 'Physical evaluation of whole cacao beans'.
- Perform a thorough microbiological analysis of unroasted beans and verify that the counts are within the acceptable limits. If the sample results exceed the acceptable limits, it is crucial to refrain from further processing the unroasted beans for sensory evaluation. It is essential to adhere to national regulations regarding acceptable microbiological limits in this process.
- Preferably, follow the manual process to avoid mixing shells with nibs.
- Minimise the contact between the cleaned nibs and the removed shells.
- Record the weight of the nibs.
- Store the nibs until further use (see Section 12.4.6).

### 12.4.6 Storage of cacao nibs

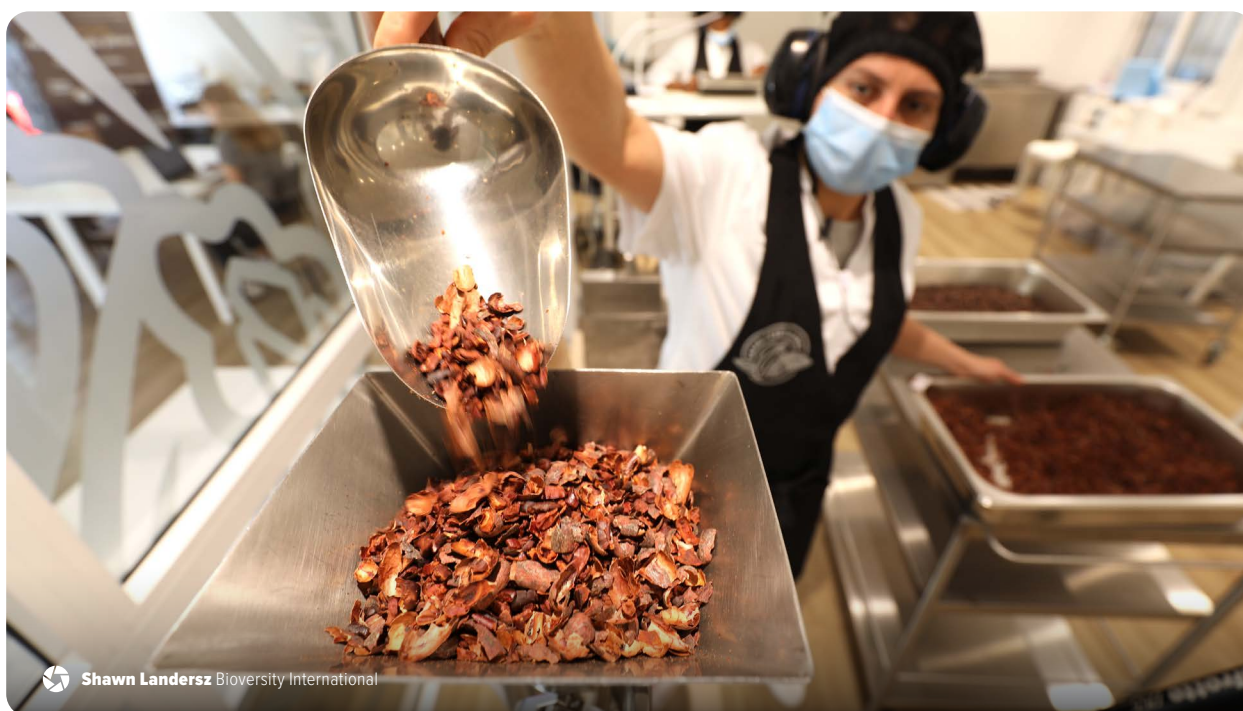
For flavour evaluation of cacao beans as mass, nibs should be processed into mass within 48 hours after winnowing. To prevent rehumidification and the absorption of odours, store the nibs for immediate use in clean food-grade containers or a multi-layer barrier film (vacuum seal type bags). If the nibs are to be processed into cacao mass at a later time, they should be stored at 10–16°C (50–61°F) no longer than seven days. Before opening the container for processing into cacao mass, allow the nibs to reach room temperature.

### 12.5 Documentation of data, calculations and results

The information necessary to document the breaking and winnowing process of each bean sample is provided in Table 26. It is crucial to accurately and thoroughly describe the process to facilitate the interpretation of sensory evaluation results for cacao mass and/or chocolate. This documentation enables comparisons among samples and effectively communicates the conditions required for process reproduction or repetition.

**Table 26.** Data to be recorded for breaking and winnowing cacao beans.

Reference sample number/ID	_____
Date processed (dd/mm/yyyy)	_____
Name of the person processing the beans	_____
Total roasted bean weight before breaking and winnowing (g)	_____
Total nib weight after breaking and winnowing (g)	_____
Yield (%) (nib weight / roasted bean weight x 100)	_____
Process used (manual, semi-manual or electro-mechanical)	_____
Breaker brand and model	_____
Winnower brand and model	_____
Other notes on equipment used	_____
<b>Comments</b>	_____



## Ch 13. Processing cacao nibs into mass

### 13.1 Objective

This protocol outlines the procedure for transforming cacao nibs into cacao mass, also referred to as cacao mass or paste, with a specific particle size. The resulting cacao mass is intended for sensory evaluation of cacao beans in the form of cacao mass or chocolate.

The steps detailed below are specific for grinders which use tension from granite stones to apply different grades of shear. This reduces the size of the nibs, ruptures their fat-containing cells, releases the cacao butter and refines the particle size of the mixture between 20 and 14µm. The particle size must not be too low, for example 10µm. This may result in a texture the texture that is overly sticky and goeey. The liquefying process can also be facilitated by pre-grinding the nibs. This protocol also describes how to measure the particle size of the cacao mass.

### 13.2 Key specifications

**Table 27.** Key specifications for processing cacao nibs into mass.

	Parameter	Specification
Minimum size of cacao nibs test sample – output of roasting, breaking and winnowing		600g
	Target for final particle size of cacao mass	14–20µm
	Maximum temperature for cacao mass processing	55°C (131°F)

### 13.3 Equipment, tools and materials

#### Cacao nibs

The test sample size should consist of the outcome of roasting 600g of cacao beans. This quantity can be increased to suit specific needs such as the working capacity of available equipment and the desired amount of cacao mass and chocolate for flavour sensory evaluation

#### 13.3.1 Grinders

- Grinders, mills, melangers, and refiners have the same function. In this Guide, the term “grinder” is used. They grind cacao nibs into cacao mass for a particle size of 20µm or less which can take 10–20 hours, without raising the temperature of the cacao mass above 55°C (131°F). See Annexes, Figure 68, Figure 69 and Figure 70.
- A grinder will have a bowl or a drum with a granite bottom and a set of stones set on an axel that can be conical or cylindrical.
- When necessary, a pre-grinding step can be carried out to facilitate liquefying. Examples are shown in Annexes, Figure 71.
- A pre-grinder will have a bowl and blades similar to a blender or mixer.

#### 13.3.2 Micrometer

The micrometer should meet the following specifications. See examples in Annexes, Figure 72.

- Analogue or digital.
- A measuring range 0–25µm.
- An accuracy 0.001µm.
- Flat measuring faces (see micrometer parts in Annexes, Figure 37).

### 13.3.3 Other tools and materials

- An oven with a temperature range of 35–100°C (95–212°F) including temperature control for warming nibs, grinder bowls and stones.
- Food-safe, heat-resistant and odour-free containers with lids, for preheating the nibs.
- A non-contact infrared thermometer with a measuring range of 0–100°C (32–212°F).
- A scale with a capacity of 2.5–10kg with a precision of 0.1g, for weighing the grinder's bowl and its content, as well as cacao mass drops, cacao butter etc.
- An infrared thermometer with a measuring range of 0–100°C/0–212°F (refer to Annexes, Figure 73).
- Neutral tasting deodorised cacao butter for lubricating the grinding stones and brushing the grinder bowl.
- A scraper.
- 2–3 spatulas.
- A piping bag.
- Parchment or baking paper (unwaxed) for producing 1–2g drops.
- Two heat-resistant trays, such as those used for baking.
- One tray of any food-safe material.
- Sterile containers for storing cacao mass.
- A refrigerator or deep-freezer for long-term storage of cacao mass.
- Timers.

## 13.4 Procedure

### 13.4.1 Cleaning

Before beginning, ensure that all working surfaces, tools, and equipment are thoroughly cleaned and disinfected, with the exception of the inside of the grinder's bowl and stones. Porous granite stones have the potential to retain soap and disinfectant, which may contaminate the cacao mass during processing. Cleaning the stones with hot water alone is recommended (refer to Section 13.4.6 'Considerations for cleaning the grinders' for further details).

Measure the weight of the cacao nibs to be ground for each sample, as well as the weight of each grinding bowl and stone.

### 13.4.2 Pre-grinding (optional)

The nibs should be pre-ground to a size of approximately 500µm (0.5mm). The pre-grinding step is employed when loading the nibs gradually into the grinder becomes inconvenient. Pre-grinding the nibs enables loading them into the grinder all at once. However, it should be noted that pre-grinding necessitates additional time for equipment cleaning, and there may be some product loss during the process.

Various equipment options for pre-grinding cacao nibs are available. Examples of such equipment are presented in Annexes, specifically in Figure 71.

Below are the steps for a coffee-type grinder (Annexes, Figure 71a):

1. Pour approximately 50g of cacao nibs into the grinder.
2. Grind the nibs to approximately 0.5mm (500µm), which will yield a coarse powder.
3. Transfer the coarse powder into a clean bowl.
4. Repeat steps 1 to 3, adding 50g at a time, until all the nibs are ground.
5. Measure the time required for pre-grinding and record the data.

### 13.4.3 Pre-heating the cacao nibs and grinding equipment

Before starting, it is recommended to warm the nibs, grinder bowl, and stones to ensure smooth rolling of the stones and prevent them from sticking, as well as to avoid overheating of the motor. This can be achieved by following the steps below, using an oven:

1. Set the oven to 40–45°C (104–113°F).
2. Pour the nibs into a food-safe, heat-resistant and odour-free container and close the lid tightly. This protects the nibs from losing aroma volatiles and picking up odours that may be present in the oven during the preheating.
3. Transfer the container with the nibs, together with the bowl and grinding stones (placed on a tray), inside the oven.
4. Allow from two to four hours to heat the nibs, bowl and grinding stones to reach a temperature of 40–45°C (104–113°F).

### 13.4.4 Grinding

1. Using a brush and melted deodorised cacao butter, lubricate the surface and the centre axel of the grinding stones. For cacao mass with high fat content the use of cacao butter to lubricate the grinding stones is an option.
2. Switch on the grinder.
3. Record the time that the grinding starts.
4. While the drum is running, add 40–50g of nibs (approximately one cup) at a time between the stones.
5. Add the next portion of nibs once the previous portion has started to liquefy, and repeat this process until all the nibs have been added. Close the lid between each pouring of nibs. Each interval typically takes between 2 to 5 minutes, and the entire process can take approximately 10–15 minutes for 600g of nibs, depending on the fermentation and fat content of the beans.
6. While pouring the nibs, it may be necessary to occasionally pause the process and use a spatula to unblock any accumulated nibs and mass.
7. Regularly monitor the temperature of the milling mass using an infrared thermometer, at intervals of every half hour during the initial 2 hours. The temperature should be maintained below 55°C (131°F). If the temperature exceeds 55°C (131°F), you can take the following measures to cool down the milling mass: ventilate the room, place a fan towards the grinder, or temporarily turn off the grinder.

8. Once the mass is at a stage where there are no visible coarse particles, regularly check the particle size of the cacao mass using a micrometer. For detailed instructions on the use of a micrometer and interpretation of a scale reading, refer to Annex 10.
9. When the cacao mass reaches the targeted particle size of 20µm or down to 14µm, turn the grinder off.
10. Record the final particle size.
11. Record the time that the grinding ends.
12. If you are not further processing the cacao mass into chocolate, proceed with pouring and storing immediately to avoid the cacao mass from solidifying in the grinder bowl (see Section 13.4.5 'Pouring and storing cacao mass' below).
13. Weigh the final poured cacao mass and record the data.



**NOTE:** The frequency of scraping, measuring temperature and measuring particle size will depend on the amount of cacao mass, and the equipment used, among other factors. It is recommended to start every hour and adjust.

### 13.4.5 Pouring and storing cacao mass

The cacao mass can be immediately poured into sterile containers and stored either as a single solid block or portioned into 1–2g drops. It is recommended to use drops if they are intended to be used within the next six months. Moreover, drops are convenient for sensory evaluation as they are already individually portioned. To minimise any potential bias in visual appearance during evaluation, it is advisable to follow a standardised method for creating the cacao mass drops of equal size. For instance, one can utilise chocolate moulds with cavities of 1–2g or a stainless steel tray with standard holes suitable for 1–2g of cacao mass.

For cacao mass stored in containers as solid mass, pour the cacao mass from the grinder bowl into the containers. Scrape the sides and stones to remove all the cacao mass.

Cover the containers while allowing to cool to room temperature. If the room temperature exceeds 23°C (73.4°F), use an odour-free cooling cabinet or fridge. Make sure that the cacao mass begins to solidify within 15–20min after liquefying, in order to avoid stratification and to obtain a homogeneous sample. Since the cacao mass is not tempered, the solidified mass may not have a shiny appearance, i.e., white spots may develop.



**NOTE:** Stratified cacao mass samples look whitish at the top, and increasingly dark at the bottom of the container. Stratification occurs when the cooling speed of warm cacao mass is slow before it solidifies. The cacao butter remains liquid longer allowing the tiny solid particles to sediment. Sedimentation increases the concentration of solids at the bottom. As a consequence, the composition and the flavour are not homogeneous in the sample. If stratification has occurred, remelt the cacao mass, mix well to homogenize it, and immediately resolidify the mass properly.

Once solidified into a block, it can be taken out of the mould or container and put into a vacuum-sealed bag.

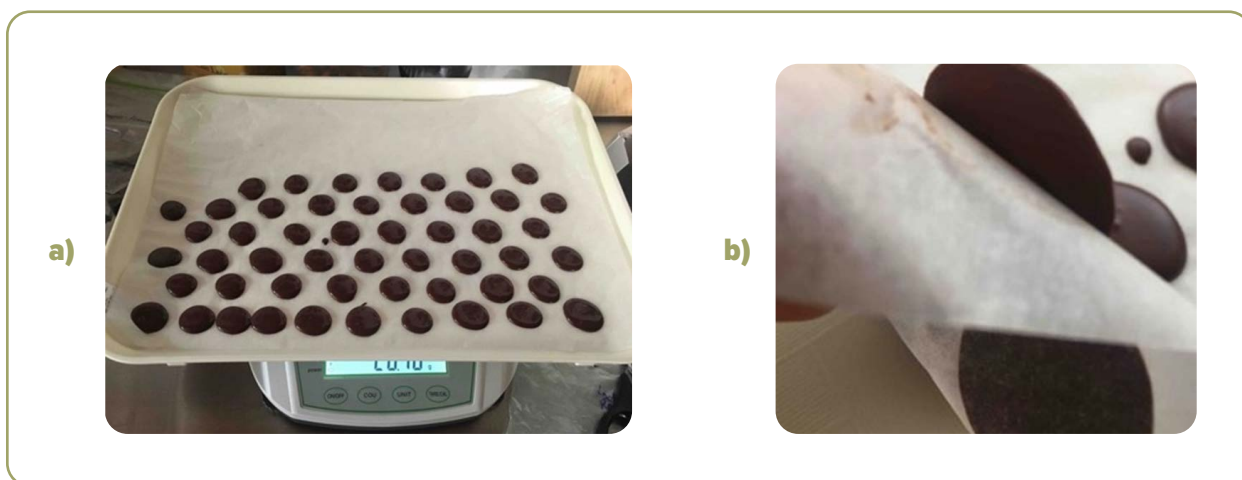
For storage, the cacao mass must be placed in sealed containers (blocks or jars) to avoid absorption of extraneous odours and/or loss of volatiles. For storage of more than one year, store in a deep freezer at -18°C (-0.4°F). If to be stored for less than one year, store in a refrigerator or in a dark place where the temperature is lower than 20°C (68°F).

All stored cacao mass, whether for short or long-term, must be labelled with a unique ID code that links it to all associated data.

When removing a sample from a deep freezer or refrigerator, leave the sample in the container sealed until the mass has come to room temperature in order to avoid moisture condensation in the cacao mass.

Steps for portioning cacao mass into 1–2g drops (see Figure 11 below):

1. Place a sheet of unwaxed parchment paper onto a tray.
2. Place the tray on the scales and tare it.
3. Fill a piping bag with warm cacao mass resulting from of the grinding process and cut the tip off.
4. Pipe a 1–2g droplet of cacao mass onto the parchment paper, guided by the weight indication on the scales. An alternative to using a piping bag is to use two teaspoons to take 1–2g portions of the mass and place them on the tray.
5. Repeat until the whole parchment paper surface is covered with cacao mass drops in parallel rows.
6. Allow the drops to cool to room temperature until the pieces solidify.
7. As these are not tempered, they will naturally not have a shiny appearance and spots will develop.
8. Wearing gloves, detach the cacao mass drops from the parchment paper into a sealed container or vacuum-sealed bag. Care must be taken in order to avoid crushing of the drops.



**Figure 11.** Producing cacao mass drops in portion size: **a)** piped drops on the parchment paper **b)** detaching drops after solidifying (Bioversity International, Alvarado, 2019).

#### 13.4.6 Considerations for cleaning the grinder

- Clean the grinder's bowls and stones using only hot water (50–70°C or 122–158°F).
- Do not use soap or disinfectant as granite has porosity that can trap soap and disinfectant and release it into the next batch of cacao mass.
- After washing with hot water only, dry the grinder bowl and stones in a warming oven at 40°C (104°F).

## 13.5 Documentation of data, calculations and results

The information required to document the grinding process for each bean sample is presented in Table 28 below. It is crucial to provide an accurate and detailed description of the grinding process. This documentation is essential for interpreting the sensory evaluation results of the cacao mass and/or chocolate, making comparisons between samples, and effectively communicating the precise grinding conditions for the purpose of reproduction or repetition.

**Table 28.** Data to be recorded for grinding cacao nibs into mass.

Reference sample number/ID	_____
Date processed (dd/mm/yyyy)	_____
Name of the person processing the sample	_____
Weight of the cacao nibs (g)	_____
Net weight of the cacao mass (g)	_____
Final cacao mass particle size ( $\mu\text{m}$ )	_____
Total refining time (hours:minutes)	_____
Maximum temperature reached during process ( $^{\circ}\text{C}$ )	_____
Pregrinder brand and model, if used	_____
Grinder type, brand and model	_____
Storage conditions of cacao mass ( $^{\circ}\text{C}$ )	_____
Final shape of cacao mass (drops/single solid masses)	_____
<b>Comments</b>	_____



# Ch 14. Processing cacao mass into dark chocolate

## 14.1 Objective

This protocol provides a detailed procedure for processing cacao mass into dark chocolate, specifically for sensory evaluation purposes, using a standardised recipe. The objective is to establish a consistent method for blending ingredients and refining the mixture to create a dark chocolate that captures the intrinsic flavours of the cacao beans. While the protocol is not designed for commercial chocolate production, its principles can be applied. This protocol refers to cacao mass processed according to the protocol described in Chapter 13 'Processing cacao nibs into mass'.

## 14.2 Key specifications

**Table 29.** Key specifications for processing cacao mass into dark chocolate.

Parameter	Specification
Target for the final particle size of the chocolate	≤18µm
Maximum temperature for chocolate processing	55°C (131°F)
% of cacao mass	63
% of cacao butter	7
% of sugar	30
Total % cacao	70

## 14.3 Equipment, tools and materials

### 14.3.1 Ingredients

The ingredients required for processing cacao mass into chocolate are as follows:

#### Melted cacao mass

The cacao mass should be melted at a temperature of approximately, 40–45°C (104–113°F) and have a particle size of 14–20µm. The required amount will vary depending on the equipment capacity and the number of panel members involved in the sensory evaluation.

#### Deodorised cacao butter

This ingredient is added to enhance the flow of the cacao mass during processing. Use deodorised cacao butter of pressed, expelled, or refined quality grades. Ensure compliance with national regulations regarding the identity standards for cacao butter, as these may vary by country. In the absence of specific regulations, refer to Codex Stan 86–1981, Standard for Cocoa Butter (Table 30 below), to verify the product specifications provided in the technical sheet or product label.

**Table 30.** Standard for cacao butter as provided by *Codex Stan 86-1981*.

Free fatty acids	≤1.75% (weight)
Unsaponifiable matter	≤0.70% (weight), except in the case of pressed cacao butter, which shall be ≤0.35% (weight)
Hexane	≤1 mg/kg, excluding press cacao butter
Moisture content	≤0.1% (weight)

## Sugar

White sugar with a neutral taste is added to provide sweetness and balance the bitterness of the cacao mass. Its neutral taste is to ensure that the only flavour flavour of the chocolate is from the cacao mass.

### Quality of ingredients

The quality of ingredients must be inspected before use, considering the following criteria:

- **Safety and absence of contaminants:** All ingredients must meet the minimum food safety standards to minimise biological, chemical, and physical hazards.
- **Proper labelling:** To ensure compliance with food and ingredient labelling regulations, including proper allergen declaration.
- **Functionality:** Check the information regarding ingredient use and functionality, especially if it affects the processing of the ingredients.
- **Absence of any flavours:** This is to ensure that the sensory evaluation is focused on the flavours of the cacao mass and not on the ingredients.

To assess the flavour neutrality of the cacao butter, follow these steps:

- Melt the cacao butter.
- Taste the melted cacao butter to check for any atypical or off-flavours.

Ensure that the cacao butter tastes clean without any undesirable flavours. Note that non-deodorised cacao butter naturally has a sweet chocolate aroma due to the presence of 2,3-Butanediol. However, this compound should not be present in the cacao butter being assessed, which is why deodorised cacao butter is used. Pay attention to any atypical or off-flavours in the cacao butter, such as mouldy, rancid, rubbery, roasted, or green flavours, as they indicate a deviation from the desired neutrality.

To assess the flavour neutrality of the sugar, follow these steps:

- Preheat the oven to either 50°C (122°F) or 65°C (149°F).
- Weigh 50g of sugar into a glass jar.
- Close the jar tightly.
- Place the jar in the preheated oven for one hour at 50°C (122°F) or for 20 minutes at 65°C (149°F).
- After the designated time, remove the jar from the oven.
- Open the jar and assess the odour that comes out. Stand close enough to perceive the aroma but maintain a safe distance to avoid burning.

The sugar should have a very light, sweet scent with only subtle hints of brown sugar or caramel notes.

Detect any off odours, such as vegetative, rotten vegetation, or fermented sugar notes. If any off odours are detected, the sugar should not be used, and an alternative source or batch should be assessed for flavour neutrality.

### 14.3.2 Mixing equipment

The following equipment and tools are required for the mixing process:

- **Grinders:** The grinders should be capable of mixing the ingredients and refining the particle size to 18µm without raising the temperature above 55°C (131°F) during the process. Examples of suitable grinders can be found in Annexes, Figure 68 and Figure 69. Other grinding equipment can be used as long as it is food-safe, achieves the target particle size, and adheres to the specified processing time and temperature limits.

- **Micrometer:** An analogue or digital micrometer (Annexes, Figure 72) with a measuring range of 0–25mm and a resolution of 0.001mm. It should have flat measuring anvil faces (refer to Annex 10).
- **Infrared thermometer:** An infrared thermometer with a measuring range of 0–100°C/32–212°F (refer to Annexes, Figure 73).
- **Scales:** Scales with a capacity to weigh 1–8000g and a resolution of 0.1g.
- **Bowls:** Three to four bowls are needed to weigh each ingredient separately.
- **Spoons:** Two to three spoons are required to serve the ingredients separately.
- **Knife and cutting board:** These are necessary for cutting portions of cacao mass blocks.
- **Oven:** An oven with a temperature range of 45–100°C (113–212°F).
- **Plastic scraper or spatula:** Used for scraping and transferring the mixture.
- **Cleaning agent and disinfectant:** These are essential for maintaining cleanliness and ensuring proper hygiene during the process.

### 14.3.3 Additional equipment for tempering

- Moulds of polycarbonate, PVC or silicon with cavities for thin chocolate bars, approx. 3–5g moulds.
- A cooling cabinet or fridge set up at 13–16°C (55.4–60.8°F).

#### For manual tempering

- A digital thermometer with a measuring range of 20–60°C/68–140°F (see Figure 78) with either a probe or infrared function.
- Well-tempered deodorised cacao butter (only for the seeding method) should exhibit certain visual characteristics to ensure it is properly tempered. It should be in a solid state, displaying a uniform appearance without any white spots on the surface. Additionally, when broken, it should produce a distinct and clear snap sound. Refer to Figure 83 for a visual reference.
- Heating equipment such as a warming oven with capacity to maintain a temperature of 40°C (104°F) or a microwave.
- Cooling equipment or tools such as:
  - » A marble slab of at least 2cm in width (Figure 76) with a working environment of 18–20°C (64–68°F).
  - » A cooling cabinet or fridge set operating at a temperature range of 13–16°C (55.4–61°F).
- Other tools and materials:
  - » A grater.
  - » A thermoresistant plastic spatula (Figure 79a).
  - » A heat gun (Figure 80).
  - » A ladle or piping bags.
  - » Non-stick, unwaxed baking paper.
  - » Paper towels.

#### For machine tempering:

There are several options available for tempering machines, which vary in price, capacity, cooling and heating mechanisms, as well as the continuous or batch system they use and the way the chocolate is kept flowing.

The specific choice of tempering machine depends on the user's needs and available resources.

This protocol covers two types of tempering machines:

- **Fully-automatic machines:** These machines can run a complete tempering program and provide a signal, either through sound or visual cues, to indicate when the chocolate is ready (see Figure 82).
- **Semi-automatic machines:** These machines feature a chocolate bowl with automatic stirring and temperature control, where the user needs to manually set each temperature (see Figure 81).

## 14.4 Procedure

### 14.4.1 Recipe

Cacao of Excellence used a standard recipe of 66% cacao content since its first Awards Edition in 2009 until 2021. Recently, Cacao of Excellence revised its recipe based on the flavour profile of the diverse beans samples from over 55 countries and taking into account market trends. It's the updated recipe for the 2023 Cacao of Excellence Awards Edition. Table 31 below details the standard recipe used now by Cacao of Excellence for processing beans into cacao mass and dark chocolate with 70% cacao content for the purpose of sensory evaluation.

**Table 31.** Standard recipe used by Cacao of Excellence to process cacao mass into chocolate for the sensory evaluation of cacao beans.

Ingredients	Composition
Cacao mass	63%
Sugar (flavour-neutral)	30%
Deodorised cacao butter	7%
<b>Total</b>	<b>100%</b>
Cacao content (cacao mass + cacao butter)	70%
Ratio of cacao mass to sugar (cacao mass/sugar)	2.1%
Fineness – particle size	14–18µm

### 14.4.2 Preparing the cacao mass

To prepare the cacao mass, follow the steps outlined below.

1. Clean and disinfect all tools and working surfaces.
2. Retrieve the cacao mass from storage and allow it to reach room temperature. To prevent condensation, keep the cacao mass samples inside their packaging or jars while they come to room temperature. If the cacao mass samples are large and have been frozen, gradually thaw them by first placing them in the fridge and then at room temperature.
3. Heat the drum and stones of the grinder in a heating oven at 40–45°C (104–113°F) for at least 1 hour.
4. Place the hardened cacao mass on a cutting board and use a knife to cut it into small pieces.

### 14.4.3 Producing the chocolate

The key stages involved in producing chocolate are the mixing and refining processes, aimed at achieving the desired particle size of 14–18µm.

The cacao mass, cacao butter, and sugar are carefully combined. The mixing occurs at temperatures below 55°C (131°F), ensuring the ingredients are well blended without surpassing this temperature limit.

The chocolate mixture is grounded, to reduce the particle size to a range of 14–18 $\mu$ m. This refining process contributes to the overall texture and smoothness of the chocolate, allowing for enhanced sensory evaluation.

### Process

1. Ensure that all tools and working surfaces are cleaned and disinfected.
2. Weigh the cacao mass, cacao butter, and sugar in separate bowls.
3. Melt the cacao butter in the oven at a temperature of 40–45°C (104–113°F), and set it aside until it is needed.
4. Start the grinder and add the melted cacao mass into the drum, allowing it to run for 2–5 minutes.
5. While the grinder is in running, carefully pour the sugar into the cacao mass in a consistent manner.
6. After the initial 30–45 minutes of grinding, use a spatula to scrape the chocolate from the interior surfaces of the drum, as well as the stones and scraper, and incorporate it back into the chocolate mass.
7. Every 2–3 hours, perform the following checks:
  - » Monitor the temperature of the chocolate mass, ensuring it remains below 55°C (131°F). If the temperature exceeds this limit, turn off the grinder for approximately one hour or until the temperature drops below the threshold before continuing the process.
  - » Assess the consistency of the chocolate mass, which should maintain a fluid state. If the mass thickens during the process, as indicated by a decrease in rotation speed of the grinding stones, add one-third of the cacao butter to the mixture by pouring it onto the stones. This allows for immediate distribution into the chocolate mass, ultimately restoring its fluidity. Repeat this adjustment as necessary until all the cacao butter has been added to the chocolate mass.
  - » Measure the particle size of the chocolate mass using a micrometer, following the instructions outlined in Annex 10. Monitor the decrease in particle size until it reaches the desired range of 14–18 $\mu$ m, when the refining process is nearly complete. At this stage, it is advisable to check the particle size more frequently, approximately every hour.
8. Once the particle size of the chocolate reaches the desired fineness of 18 $\mu$ m, stop the grinder.
9. Remove the stones along with their axle from the grinder, and scrape all the chocolate from the sides of the stones and the centre axle into the drum. Exercise caution not to scrape any gritty or dry solids, as these may be particles that did not achieve the target particle size. These parts should be discarded. Set aside the stones with the axle for cleaning.
10. Transfer the liquid chocolate into a bowl in order to proceed with the tempering and moulding process (refer to Sections 14.4.4 and 14.4.5 below).



**NOTE:** The time needed to complete the chocolate-making process usually depends on the following factors:

- Amount of chocolate mixture (longer time needed for larger volumes).
- Chocolate recipe chosen (proportion of ingredients).
- Composition of the cacao mass (cacao butter content).
- Efficiency of the grinder (technical specifications).
- Grinding temperature (the higher the better without exceeding 55°C– 131°F).

The chocolate making process can take at least ten hours, depending on the quantity being produced. For instance, when mixing and refining 500g of chocolate to a particle size of 18µm using a grinder with a capacity of 250–1000g, it can take anywhere from eight to twelve hours.

It is critical that during the chocolate making process and the grinders are never left unattended. If the grinding operation needs to extend beyond regular working hours, the machines should not be left running without supervision. Unlike grinding cacao nibs into a mass, where the temperature typically rises only at the beginning, the addition of sugar to the cacao mass during the chocolate processing increases its viscosity, and consequently, the temperature can exceed the recommended limit of 55°C (131°F). To mitigate this, cacao butter is added to reduce viscosity and, in turn, lower the temperature. However, this process must be closely supervised, as the risk of the temperature surpassing the recommended maximum can result in damage to the mass and flavour, as well as pose a fire hazard.

In the event that the process needs to be interrupted, place the drum containing the chocolate, covered with a lid or plastic wrap, into an oven set at 40°C (104°F) until it is ready for grinding again. This ensures that the mixture remains warm and in a liquid state, enabling the process to resume promptly the following day.

#### 14.4.4 Tempering the chocolate

There are various methods to temper chocolate, involving precise temperature manipulation during the crystallisation process of cacao butter. Cacao butter serves as the food matrix in chocolate, suspending sugar and cacao solids. This fat can crystallise in six different forms (I – VI). Among these forms, the presence of tiny crystals of type V is desirable in the melted chocolate, as it maintains a fluid consistency. A properly tempered chocolate should always remain fluid without any crystallised lumps.

The ideal room temperature for chocolate tempering is approximately 20°C (68°F), with a relative humidity of 40%.

##### Tempering chocolate by hand following the seeding method

Tempering chocolate by hand using the seeding method involves melting the chocolate mass to a specific temperature and introducing the desired crystal type V, found in cacao butter, into the melted mass. This seeding process stimulates the replication of the type V crystals throughout the mass, ensuring a uniform distribution. The following steps outline the process:

- Transfer the chocolate mass from the grinder drum into a bowl. If the chocolate is in solid form, chop it into pieces and place them in the bowl. Proceed to heat the chocolate mass to 45°C (113°F) to melt all types of crystals.
  - Grate the solid, well-tempered cacao butter fine. The amount needed is equal to 0.5% of the total chocolate mass to be tempered.
1. Cool the heated chocolate mass from 45°C (113°F) to 32.5 °C (90.5°F), choosing one of the following methods:

- b. Pour a portion of the chocolate mass onto a marble slab to cool it, and then mix it with the remaining warm chocolate. Practice is required to determine the right timing and amount for specific conditions. Take the temperature measurement when mixed with the warm chocolate.
  - c. Continuously mix the chocolate mass at room temperature (around 20°C or 68°F) until it reaches 32.5°C (90.5°F).
  - d. Place the bowl containing the chocolate mass in the refrigerator for a few minutes, then remove it and mix well until the mass reaches 32.5°C (90.5°F).
2. Add the grated, well-tempered cacao butter, which should be 0.5% of the weight of the chocolate mass.
  3. Stir the mixture continuously for 1 minute, ensuring that all lumps are thoroughly eliminated.
  4. Proceed to mould the chocolate immediately.



**NOTE:** It is not recommended to use a hot water bath for heating the chocolate mass, as it would increase the relative humidity in the room. If necessary, follow the recommendations in Figure 74.

### Tempering chocolate with a machine

Refer to the user's manual of the chosen tempering machine and follow the instructions to set up a tempering program suitable for dark chocolate. The specific settings will vary depending on the machine.

To ensure the optimal temperature for the tempering machine, perform a temperature testing method using pieces of thick paper dipped in chocolate.

The steps are as follows:

- Melt the chocolate in a bowl at 45°C (122°F).
- Cut 20 small strips of thick paper and write temperatures ranging from 29°C to 32°C (84°F to 90°F) in increments of 0.2°C (0.4°F) on each strip. You should have a total of 16 paper strips.
- Transfer the melted chocolate at 45°C (122°F) into the tempering machine.
- Set the cooling temperature on the machine to 29°C (84°F).
- When the cooling temperature display reaches 32°C (90°F), dip the end of the first paper strip marked 32°C (90°F) into the chocolate and set it aside.
- When the temperature screen shows 31.8°C (89°F), repeat the process for each subsequent 0.2°C (0.4°F) decrease in temperature until you have 16 strips of chocolate samples with their recorded temperature.
- Set the machine to heat to 45°C (113°F) to prevent solidification of the chocolate.
- Allow the strips of chocolate samples to set at room temperature (about 20°C [68°F] for 30 minutes).
- Examine the paper strips and identify the one on which the chocolate has set with the most glossy/shiny appearance. This specific temperature should be programmed into the tempering machine for the particular chocolate being tested.

## 14.4.5 Moulding of chocolate

### Moulding

1. Keep the moulds at room temperature (warm) and place them on the working surface.
2. Fill the piping bag with the tempered chocolate and cut the tip off or use the ladle, a piping bag will ensure more precision and less loss of chocolate mass.
3. Pipe the chocolate into each cavity of the moulds.
4. After filling the moulds with chocolate, to ensure even distribution and remove any air bubbles, gently tap the moulds on the working surface to vibrate them. This tapping action helps evenly spread the chocolate in the cavities of the moulds and eliminates any trapped air bubbles.
5. Place the moulds inside a fridge at 4–8°C (39–46°F) for 10 minutes or a cooling cabinet with a temperature of 13–16°C (55–61°F) for a maximum of 30 minutes. This will depend on bar thickness and the humidity of the environment. Do not leave in the cooling cabinet or fridge longer than the times mentioned as this can lead to water condensation on the surface of the chocolate.
6. When chocolate pieces (bars) become loose from the mould cavity, remove the moulds from the cooling cabinet or fridge.
7. To unmould the bars, first crack the mould and turn it over on a clean surface in one decisive and rapid movement.
8. It is advisable to wear gloves when handling the chocolate bars to prevent them from melting, fingerprints and maintain food safety.
9. After unmoulding, place the chocolate bars in a suitable storage container or pack them in sealed bags to ensure freshness and proper storage.

### Cutting shapes without moulds

1. Prepare a tray or tablet by placing a sheet of baking paper on it.
2. Pour the tempered chocolate directly from the bowl onto the baking paper, spreading it to create a layer with a thickness of about 3mm.
3. Transfer the tray or tablet to a cooling cabinet set up at 13–16°C (55–61°F) or a fridge with a 4–8°C (39–46°F) temperature range.
4. Monitor the chocolate's appearance as it transitions from shiny to a satin-like texture, but has not fully solidified. Once it has reached this desired appearance, take the tray or tablet out of the cooling cabinet or fridge and cut the chocolate into squares of the desired size. Place them back into the fridge or cooling
5. When the chocolate squares have solidified, remove the tray or tablet from the cooling cabinet or fridge.
6. Wear gloves to handle the chocolate bars, ensuring they don't melt and maintaining food safety. Carefully detach the chocolate pieces from the baking paper.
7. Place the chocolate pieces in a suitable storage container or pack them in sealed bags to maintain freshness and proper storage.

## 14.5 Documentation of data, calculations and results

**Table 32.** Data to be recorded for the chocolate-making process.

Reference cacao bean sample number/ID	_____	_____
Date processed into chocolate (dd/mm/yyyy)	_____	_____
Name of the person processing the sample	_____	_____
<b>Recipe used - Ingredients</b>	<b>Proportion (%)</b>	<b>Weight (kg)</b>
Cacao mass	_____	_____
Deodorised cacao butter	_____	_____
Sugar	_____	_____
Type of sugar – sugar cane, beetroot, etc.,	_____	_____
<b>Total amount of recipe</b>	<b>100%</b>	_____
Total weight of chocolate produced (g)	_____	_____
Total grinding time to reach the target particle size (hh:mm)	_____	_____
Final particle size (µm)	_____	_____
Maximum temperature reached during the mixing and refining process (°C or °F)	_____	_____
Deodorised cacao butter information	_____	_____
Sugar description	_____	_____
Comments	_____	_____
Date of tempering	_____	_____
Storage temperature	_____	_____





## PART D | SENSORY EVALUATION

### Chapter 15. **Introduction**

This section outlines the protocols for conducting sensory evaluation of cacao beans, whether in the form of unroasted beans coarse powder or processed into cacao mass and dark chocolate.

Key considerations encompass the selection and conduct of sensory evaluation panel members and individual assessors, appropriate facilities and environment, cacao-related sample preparation, serving methods, and the sensory evaluation process.

The outcomes of the sensory evaluation are presented as flavour profiles for each cacao sample, along with a global quality score. To facilitate accurate interpretation of flavour characteristics, a glossary of terms is provided, which includes descriptors and scales for flavour intensity. These are based on the Cacao of Excellence Glossary of Terms that includes the description of the flavour attributes and intensity scale and the global quality score and the Flavour Wheel. The sensory evaluation results should be documented using the evaluation form as well as the conditions under which the evaluations took place.

# Ch 16. **General guidelines for sensory evaluation**

## **16.1 Objective**

The objectives of this section are to provide guidance and promote the effective implementation of best practices and principles for sensory evaluation in assessing the quality and flavour of fermented and dried cacao beans. This applies to unroasted cacao beans, cacao mass, and dark chocolate. The section covers the following key areas:

- Sensory evaluation facilities and environment.
- Preparation of cacao beans, mass, and chocolate for sensory evaluation.
- Guidelines for sensory evaluation assessors.

The details of the sensory evaluation procedures, such as numbering, coding, and sample setup, are outlined. Reliable and consistent sensory data generated through these practices are essential for obtaining accurate and meaningful insights into the evaluated cacao products.

## **16.2 Sensory evaluation facility and environment**

When choosing or designing a sensory evaluation facility, the following elements should be considered:

- A location that is accessible and free from noise and odours.
- A construction that pays attention to wall colour, and lighting fixtures as well as the quality of construction.
- An internal layout that allows for the privacy of assessors and enables a smooth flow of samples and communication of data.
- An environment that provides good ventilation, a comfortable room temperature and relative humidity.

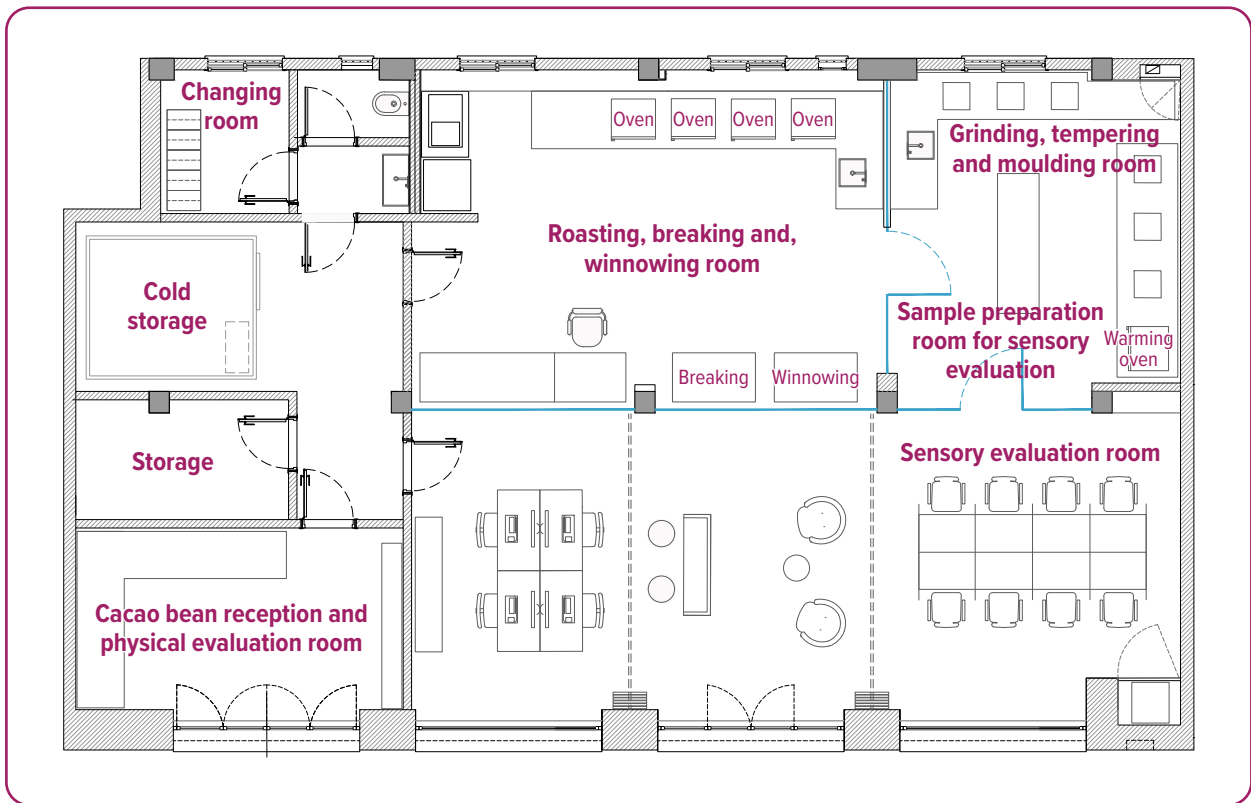
In most cases, the layout of a sensory evaluation facility is divided into three main areas: sample preparation, sample tasting, and offices/administration. The sample preparation area serves as a temporary storage space for cacao samples, where they can be prepared (e.g., melted) and organised along with other necessary materials. The tasting area is where assessors conduct individual evaluations without interruptions or distractions, or engage in group discussions for consensus evaluations. These areas should be located in close proximity to facilitate the serving of samples, while also ensuring sufficient separation to minimise potential interference. Assessors should enter and exit the tasting area without passing through the preparation area to avoid access to information that may bias their evaluation. For reference, Figure 12 provides an example layout of such a facility.

The following additional facilities can be considered:

- Storage rooms for supplies.
- Cold storages for cacao samples.
- Offices and classrooms.
- Changing room and toilets.

### **16.2.1 Area for the preparation of the cacao-related samples**

Before evaluating cacao-related samples, it is important to plan and prepare the number of assessors, the number of samples to be evaluated and the sample serving order. These considerations help ensure a well-organised and systematic evaluation process.

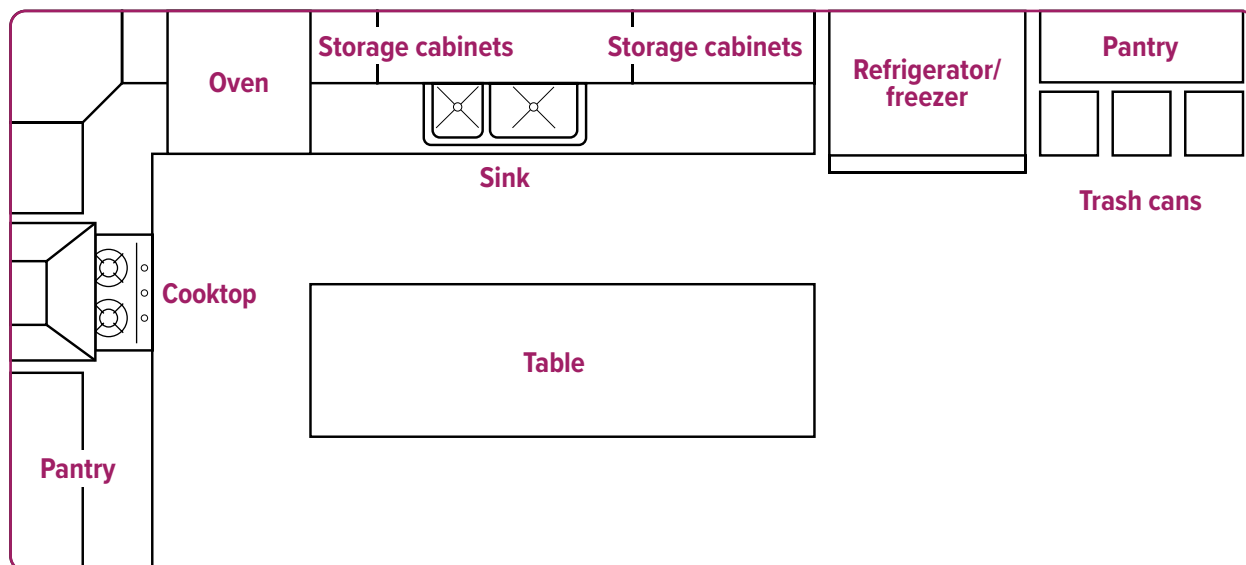


**Figure 12.** Example of a sensory evaluation facility: Layout of the Cacao of Excellence laboratory in Rome, Italy.

The key features of an ideal sample preparation area are as follows:

1. **Physically separated from the sensory evaluation area:** While the sample preparation and sensory evaluation areas should be adjacent to each other to facilitate the transfer and serving of samples to the assessors, it is ideal to keep a physical barrier between them. This is important as it:
  - Prevents the risk of information leakage (e.g. identity of the samples to be evaluated) that can lead to bias.
  - Minimises potential distractions from the sample preparation area (e.g. external noise or odours) that can affect the manner assessors evaluate the samples.
2. **Kitchen-style layout:** The area should include a sink, stove, refrigerator, freezer and storage cabinets. Sample storage space will be needed for the refrigeration and freezing of cacao mass and chocolate, storage cabinets for utensils, serving containers, spittoons, documents and other materials used for sample preparation and sensory evaluation. In addition, the area will need sufficient counter top space for sample preparation and serving arrangements. The design and construction of the area, including the placement of fixed equipment, should support ease of cleaning and maintenance.
3. **Availability of appropriate equipment and facilities:** The area should support the minimum technical requirements for equipment and tools as specified in this guide, such as:
  - Outlets for connecting to electrical appliances and devices such as grinders, blenders and heating equipment.
  - Refrigerators to store cacao beans, cacao mass, and chocolate samples, especially when the room temperature exceeds 22°C (72°F) for immediate or short-term storage (less than one year). Freezers should be utilised for longer-term storage exceeding one year.

- An adequate ventilation system with air filters and fume exhausts for the preparation of products with aromatic properties.
- An adequate clean water supply.
- Installed garbage disposals and trash cans.



**Figure 13.** Example of layout for sample preparation similar to a kitchen environment.

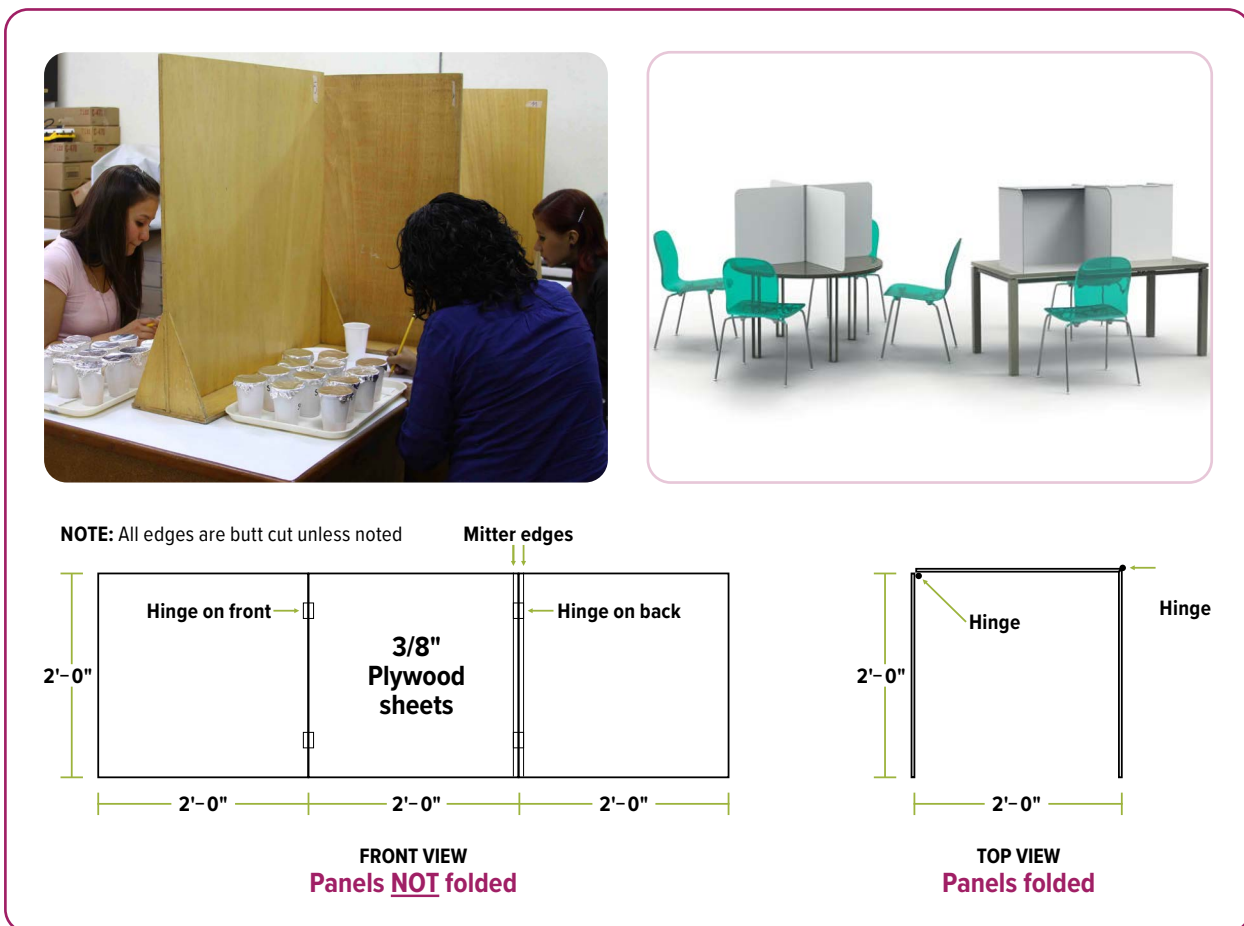
### 16.2.2 Area for performing sensory evaluations

The sensory evaluation area should be designed to minimise biases, enhance assessor sensitivity, and eliminate external influences to ensure evaluations are performed in a quiet, uninterrupted environment.

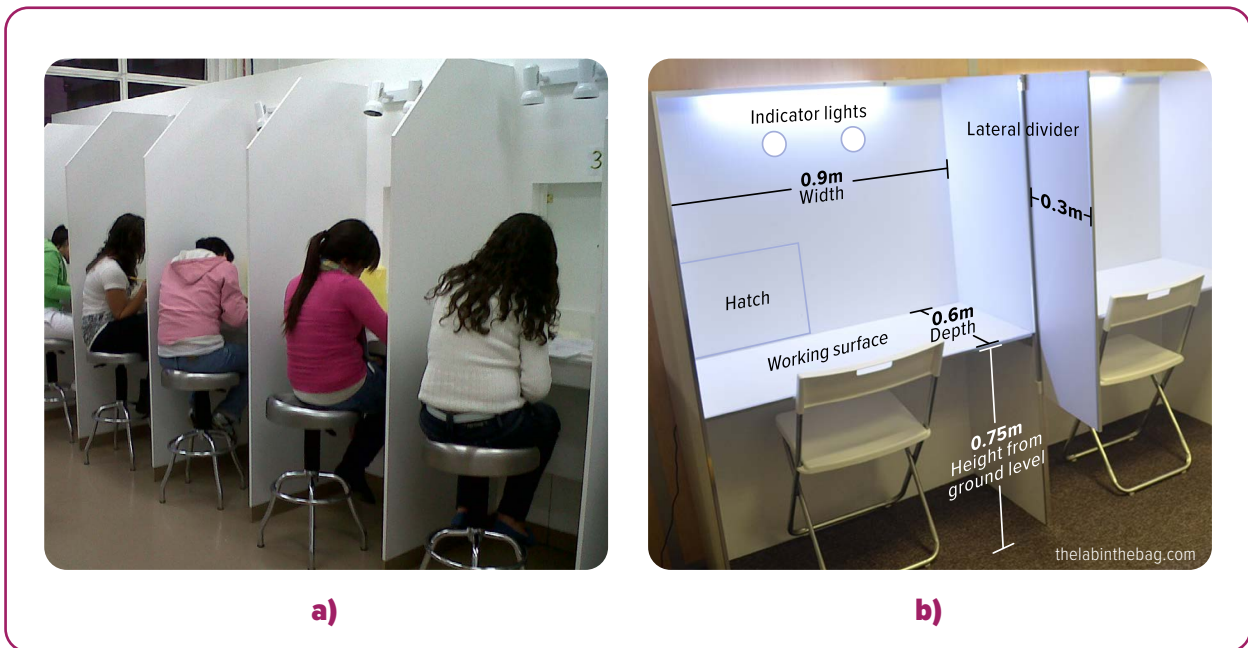
The key features of an ideal sensory evaluation area are as follows:

- Convenient and central location to accommodate an adequate number of participants.
- Isolated from sources of odours and noises to prevent distractions. Cleaning products used in the area, particularly in the sample preparation and tasting areas, should be odour-free.
- Effective ventilation and airflow, with the inclusion of activated carbon filters in the ventilation system or air conditioner to absorb odours. If necessary, a slight positive air pressure can be created in the tasting area to minimise the inflow of air from other areas.
- Simple furnishings and neutral colour schemes, such as off-white and light neutral grey, to minimise distractions and maintain assessor focus. Countertops should be smooth, non-absorbent, and easy to clean.
- Sufficient lighting in the sample preparation and tasting areas, with shadow-free illumination equivalent to office lighting intensity levels of 300–500lux and 700–800lux at the table surface.
- Availability of a signalling communication system, such as the use of coloured light bulbs operated by a switch, to facilitate communication among assessors.
- Maintain a comfortable relative humidity of 45–55% and a temperature ranging from 20–22°C (68–72°F) within the sensory evaluation area.
- Provide spacious tasting areas with approximately one metre squared (1m<sup>2</sup>) of space per person to accommodate assessors, test and reference samples, as well as data entry systems.

- Provide individual seating areas, booths, or partitions in the tasting areas to prevent assessors from influencing or interrupting each other. If possible, physically separate the assessors by placing tables with movable partitions made of non-resinous wood or plywood, painted with low-odour water-based paint in a neutral colour (see Figure 14). Use opaque, non-reflective dividers between individual booths that are easy to clean. Ideally, the dividers should extend about 46cm (18in) beyond the countertop to minimise auditory and visual distractions. While privacy is important, ensure adequate ventilation and space for cleaning.
- Consider permanent individual booth partitions equipped with electrical outlets for computerised data entry systems and necessary electrical appliances. Each booth should have controlled lighting and a serving hatch connecting to the sample preparation area. The number of booths depends on available space, typically ranging from 3 to 25.
- Sinks are not recommended in the sensory evaluation area to avoid odour contamination, and spittoons or dedicated cups should be provided.
- Furnish the area with comfortable chairs and tables at appropriate heights, allowing sufficient space for evaluating samples and using any necessary devices such as computers and keyboards
- Include a separate discussion area for briefings, discussions, or consensus-building exercises. Equip this area with tools such as blackboards or whiteboards, odour-neutral markers, papers, and visual aids.



**Figure 14.** (Top) Sensory areas equipped with tables and movable partitions constructed from non-resinous wood or plywood painted with neutral colours. (Bottom) Example of a construction layout for portable sensory booths. (Alejandro Anzueto/Universidad del Valle de Guatemala; <https://thelabinthebag.com> and Lawless and Heymann, 2010).



**Figure 15.** a) Fixed sensory evaluation booths that are individualised and limit interactions between assessors; b) Sample layout for a single, fixed sensory evaluation booth. (Alejandro Anzueto/Universidad del Valle de Guatemala and ISO 8589:2007).

## 16.3 Preparation of samples, serving, and sensory evaluation

Standardisation is crucial when preparing, serving, and evaluating samples. It ensures consistent and reliable results. To achieve standardisation:

- Prepare all samples under the same conditions, using the same location, person, and utensils.
- Store samples in identical storage equipment, such as refrigerators, freezers, or storage cabinets.
- Ensure that samples have uniform visual appearance, size, shape, and serving temperature during evaluation to minimise biases.
- Use identical tools for serving samples to avoid influencing sensory attributes. For instance, when evaluating cacao mass, use odour-neutral cups with lids to preserve aromas and prevent external odours from interfering.
- Maintain an equal number of samples per session for all assessors for consistency.

### 16.3.1 Palate cleansing between samples

In a sensory evaluation session, multiple samples are often tasted. While water aids in removing residual materials from the tongue after tasting a sample, palate cleansers are utilised to thoroughly cleanse and neutralise the oral cavity. This process eliminates lingering flavours and residues in the mouth, ensuring that there is no flavour overlap, particularly when evaluating samples with diverse flavour profiles.

To cleanse the palate between tasting cacao mass or chocolate samples, the proceeding steps can be followed:

1. Rinse the mouth with warm water at temperature of  $40\pm 2^{\circ}\text{C}$  ( $122\pm 4^{\circ}\text{F}$ ) and spit it out.
2. Chew a small piece (approximately  $2\times 2\text{cm}$ ) of water cracker (see description below) using only the front teeth. Move the crumbs around with the tongue to capture any remaining particles from the cacao mass or chocolate and swallow.
3. Rinse the mouth again with warm water and spit out.

4. Rinse the mouth for the third time with warm water and swallow.

Several palate cleansers, typically of food origin, can be used during the process. These may include:

- Non-yeast, unsalted and flavourless water crackers (made only with flour and water) as recommended by Cacao of Excellence.
- Solutions of pectin or carboxymethylcellulose, particularly for assessing astringency.
- Fresh produce such as apple, baby carrots and cucumber.

### **16.3.2 Number of cacao-related samples and instructions**

Instructions for assessors should be communicated clearly and concisely, preferably in both verbal and written formats, aligning with standard operating procedures. Sufficient quantities of cacao-related samples should be available, considering the number of assessors, portion sizes, the number of attributes to be evaluated, and the desired number of replications.

The maximum number of samples that can be evaluated in a single session is determined by factors such as sensory adaptation and fatigue. Fatigue can be influenced by the sample size and number of samples per tasting session. The complexity of the task can also contribute to fatigue. Many cacao evaluation experts find that tasting chocolate is more tiring than tasting cacao mass.

It is important for the panel to reach an agreement on the number and size of samples to be tasted prior to the evaluation session. When reference samples are used before each session, it is advisable to limit the total number of samples tasted to a maximum of 10 per session. It is also recommended to take a break until the next session to allow the senses to rest and recover.

In analytical sensory evaluation, it is generally recommended to spit out the product rather than swallow it. This helps to reduce the carry-over effect or the influence of one product on the perception of the next.

### **16.3.3 Blind coding samples**

Blind coding and labelling of samples play a crucial role in preventing assessors from having any information about the samples beyond what is indicated on the container. This practice is essential to eliminate potential biases related to the origin and processing of the samples.













For coding, it is recommended to use random three-digit numbers. It is important to avoid using numbers that may hold significance or create biases among the assessors. Examples like 911 should never be used. Various tools such as Microsoft® Excel®, online random code generators, and tables of random numbers can be employed to generate these codes (refer to Figure 16). Maintaining a record of sample identities and codes is essential. The blind codes should be written on both the serving container and its lid or cover to minimize the risk of sample mix-up.

### **16.3.4 Randomised order of samples**

Randomisation of the sample presentation order is necessary for statistical validity and to mitigate any potential order effects, particularly the first-position order effects. This practice is particularly helpful in scenarios where carry-over effects may occur.

To minimise the impact of first-position order effects, randomisation can be implemented by ensuring that each sample is presented in the first position an equal number of times, thus distributing the effect evenly across all samples and assessors. Another approach is to serve a dummy sample as the initial presentation. Examples of randomisation can be found in Tables 33 and 34.

**Table 33.** Example of sample coding and serving orders for 6 samples evaluated by 6 assessors.

	 <b>SAMPLE A</b>	 <b>SAMPLE B</b>	 <b>SAMPLE C</b>	 <b>SAMPLE D</b>	 <b>SAMPLE E</b>	 <b>SAMPLE F</b>
<b>ASSESSOR</b>	 <b>820</b>	 <b>314</b>	 <b>582</b>	 <b>172</b>	 <b>738</b>	 <b>552</b>
<b>I</b>	6 <sup>th</sup>	4 <sup>th</sup>	3 <sup>rd</sup>	2 <sup>nd</sup>	5 <sup>th</sup>	1 <sup>st</sup>
<b>II</b>	2 <sup>nd</sup>	1 <sup>st</sup>	6 <sup>th</sup>	5 <sup>th</sup>	4 <sup>th</sup>	3 <sup>rd</sup>
<b>III</b>	4 <sup>th</sup>	2 <sup>nd</sup>	1 <sup>st</sup>	3 <sup>rd</sup>	6 <sup>th</sup>	5 <sup>th</sup>
<b>IV</b>	3 <sup>rd</sup>	6 <sup>th</sup>	4 <sup>th</sup>	5 <sup>th</sup>	2 <sup>nd</sup>	1 <sup>st</sup>
<b>V</b>	1 <sup>st</sup>	2 <sup>nd</sup>	5 <sup>th</sup>	6 <sup>th</sup>	3 <sup>rd</sup>	4 <sup>th</sup>
<b>VI</b>	5 <sup>th</sup>	3 <sup>rd</sup>	1 <sup>st</sup>	4 <sup>th</sup>	2 <sup>nd</sup>	6 <sup>th</sup>
<b>Notes</b>	_____					

**Table 34.** Example of the final serving order for each assessor with codes.

<b>ASSESSOR I</b>	 <b>552</b>	 <b>172</b>	 <b>582</b>	 <b>314</b>	 <b>738</b>	 <b>820</b>
<b>ASSESSOR II</b>	 <b>314</b>	 <b>820</b>	 <b>552</b>	 <b>738</b>	 <b>172</b>	 <b>582</b>
<b>ASSESSOR III</b>	 <b>582</b>	 <b>314</b>	 <b>172</b>	 <b>820</b>	 <b>552</b>	 <b>738</b>
<b>ASSESSOR IV</b>	 <b>552</b>	 <b>738</b>	 <b>820</b>	 <b>582</b>	 <b>172</b>	 <b>314</b>
<b>ASSESSOR V</b>	 <b>820</b>	 <b>314</b>	 <b>738</b>	 <b>552</b>	 <b>582</b>	 <b>172</b>
<b>ASSESSOR VI</b>	 <b>582</b>	 <b>738</b>	 <b>314</b>	 <b>172</b>	 <b>820</b>	 <b>552</b>

## 16.4 Considerations for sensory assessors

The selection of assessors for sensory evaluation should be based on specific criteria related to the tasks, type of sensory test, and the food product being evaluated. Various factors that may influence assessors' performance should be carefully considered to ensure efficient sensory evaluation, both at an individual and panel level. These factors pertain to the selection, training, performance, monitoring, and evaluation of assessors.

- **Selecting assessors:** Assessors should be selected based on their experience with the products to be evaluated, availability, commitment, and their incentives for participation (such as monetary compensation, recognition, or employment benefits). Recruitment processes can include questionnaires

to gather information about food preferences, allergies, restrictions, and general interest in participating. Additionally, assessors may undergo a medical examination to assess their overall health condition, as well as screening tests for sensory acuity, such as threshold discrimination, difference testing, ranking tests, etc. The number and diversity of recruited assessors should also be taken into account.

- **Training assessors:** Training should involve an orientation session that provides background information on the project, general good practices, the specific food product(s) to be evaluated (including the number and types), the type of sensory evaluation test, and the expected level of commitment. Training materials should include reference samples, a training manual, forms, data sheets, etc. Evaluation procedures should cover sample preparation and serving, the flavour attribute or descriptor lists (glossary of terms), the scoring system, the use of scales, etc.
- **Assessors' conduct during sensory evaluations:** Assessors as well as anyone involved in sample setup and handling should avoid using strong scents, perfumes, or aftershaves. Hands should be washed with scent-free soap before tasting. Individuals with colds or respiratory tract infections should not attend or participate in sample preparation and sensory evaluation sessions. Ideally, evaluations should take place at least two hours after a meal and one hour after consuming items such as cigarettes, coffee, spicy food, alcoholic beverages, or engaging in strenuous exercise. The date and time of day should be noted on the sensory score sheet.
- **Instructions:** Clear and concise instructions should be provided to assessors before the evaluation begins, both verbally and in written form. Assessors should feel comfortable asking questions if they are unsure about the instructions. Instructions can be pre-tested on individuals who are unfamiliar with sensory evaluation and the project. Assessors should strive to be independent in their evaluations, following their initial instincts and trusting their abilities. They should avoid making facial expressions or verbalising their reactions until everyone has finished tasting. Assessors should also refrain from discussing the evaluation until everyone has completed the sensory assessment.
- **Evaluation and monitoring of performance:** Similar to any analytical or measuring apparatus, assessors should undergo regular checks to ensure their ability to conduct evaluations consistently and validly. It is important to monitor assessors' performance individually and in comparison to the panel, considering factors such as repeatability, discrimination capacity, and alignment with other panel members. Clear criteria and procedures for evaluating assessors' performance should be defined and presented to the sensory evaluation panel.

For descriptive analysis, assessors' performance, particularly in using scales, can be evaluated and calibrated as necessary for each attribute, using appropriate reference materials like cacao mass or chocolate.

Maintaining assessors' motivation to participate in sensory evaluation sessions is crucial. This can be achieved through a feedback and/or reward system that instils a sense of purpose and significance among the assessors. Feedback on assessors' performance can be presented by sharing data on their individual performance across sessions and comparing it with other assessors in the panel. It is essential to maintain assessor anonymity, ensuring that panel members only receive their own feedback and not that of other members.

Certificates of attendance or evaluation performance can serve as effective motivators. By implementing these strategies, assessors are more likely to stay engaged and dedicated to their roles in sensory evaluation.

8	2	0	3	1	4	5	8	2	1	7	2	7	3	8	5	5	2	9	0	6	3	1	8	4
0	8	7	3	3	1	9	7	5	2	5	7	8	9	8	0	3	8	2	5	1	2	7	5	2
2	3	3	8	8	1	4	2	4	0	2	6	1	8	9	5	2	8	9	8	3	4	0	1	0
4	7	5	5	8	3	0	7	7	1	9	1	8	1	7	4	1	7	1	3	7	9	3	3	7
1	9	3	9	5	3	4	9	5	5	2	7	5	8	0	3	4	8	8	1	2	7	5	3	4
2	8	7	8	1	4	1	4	9	4	2	4	1	5	2	9	4	8	2	1	5	2	8	1	9
8	4	8	5	1	3	9	8	6	0	7	2	1	9	0	2	0	8	7	0	8	0	1	3	0
0	3	8	8	4	7	5	1	5	1	7	3	4	5	2	0	7	4	7	9	8	6	7	7	4
3	5	3	1	9	3	7	4	9	5	0	2	0	1	4	6	2	5	4	5	8	5	0	9	2
3	4	5	9	5	2	7	9	8	9	0	5	5	8	5	1	7	7	3	5	5	4	7	7	2
4	1	5	3	0	9	1	3	7	2	5	8	7	7	1	3	6	3	9	7	8	7	9	1	7
7	2	9	5	6	7	8	5	4	5	3	4	5	4	1	9	8	8	7	5	7	9	3	1	8
5	9	2	8	9	8	6	4	4	1	5	3	7	7	0	8	0	2	5	6	0	8	1	2	0
1	3	3	3	9	0	5	2	8	7	4	0	9	0	3	7	3	1	7	9	4	5	5	2	8
4	8	0	1	0	8	6	2	1	0	0	5	0	3	1	5	4	9	0	3	7	4	7	0	1
7	7	0	8	6	3	2	8	8	5	8	9	5	8	4	0	5	9	1	8	0	5	4	9	4
3	3	8	5	7	5	7	4	3	4	5	7	9	8	9	5	0	7	7	6	8	8	8	5	9
9	1	7	1	3	6	9	2	9	1	9	4	2	3	3	0	8	1	8	7	7	6	4	7	2
6	2	2	8	0	9	4	5	3	7	2	5	4	8	8	5	6	6	5	0	4	6	5	6	8
1	7	5	9	0	0	2	0	5	8	5	8	5	1	9	5	3	3	7	4	0	5	8	2	4
0	3	9	6	9	4	7	3	5	7	0	8	5	4	7	1	1	8	5	3	2	8	0	9	8
3	0	8	2	8	1	4	4	1	8	7	8	6	9	9	9	7	5	8	9	8	4	5	9	0
9	4	9	1	2	2	0	1	3	2	4	8	7	9	1	8	8	2	9	8	3	2	8	2	9
7	2	5	1	4	4	9	8	5	2	8	5	5	1	0	8	2	6	2	0	8	9	2	2	3
9	9	2	5	7	4	3	1	2	3	8	4	1	5	2	4	0	4	2	2	8	7	1	8	2
2	0	9	1	8	9	4	4	8	1	4	8	8	7	9	2	5	0	8	9	3	3	0	1	2
8	5	2	8	1	2	1	7	7	1	4	7	8	1	4	2	7	3	7	4	0	0	1	2	9
1	2	9	9	8	4	2	5	3	2	7	4	3	2	3	3	8	5	3	3	8	5	5	3	2
3	2	8	3	7	9	6	0	4	8	8	0	5	4	1	1	4	9	0	5	0	9	4	4	1
0	9	3	4	1	1	9	5	8	3	2	4	6	7	3	4	4	9	2	3	7	2	5	7	8
8	7	5	3	4	2	1	5	5	0	1	2	4	7	5	5	2	8	8	7	8	2	8	0	3
9	6	0	1	3	0	5	3	8	6	2	9	6	0	3	4	7	8	1	1	9	1	6	5	3

**Figure 16.** Table of random numbers: start on any column or row and read in any direction to create random three-digit numbers to label the sample cups. (Lawless and Heymann, 2010).

# Ch 17. Sensory evaluation of unroasted cacao beans as coarse powder

## 17.1 Objective

This protocol\* outlines the procedure for preparing and conducting sensory evaluation of unroasted cacao beans ground into a coarse powder. The primary objective is to perform an initial quality screening of fermented and dried but unroasted cacao bean samples, complementing the physical evaluation and aroma profile obtained from whole and cut beans. This evaluation helps identify defects, off-flavours, and other characteristics relevant to decision-making processes. Additionally, it provides an indicative flavour profile and overall quality assessment that can be expected once the beans are roasted and processed into cacao mass or chocolate.

The process can be conducted either in the field or a laboratory setting, with or without access to electricity, and by an individual assessor or a panel of assessors. This method serves as a complement to the sensory evaluation of cacao beans as mass or chocolate. It offers a quick and cost-effective tool for monitoring the quality and flavour potential of a small, uniform cacao bean sample at an early stage of the value chain, following harvest and post-harvest processes. It is important to note that the results obtained will be indicative and should be interpreted with caution, considering the representativeness of the tested sample (as explained in Chapter 5, 'Sampling bagged and bulk cacao beans'). It is also essential to recognise that flavour precursors develop during the roasting process, and the particle size of the powder can impact the release of flavour compounds.

*\*The content of this protocol was developed by the Fine Cacao and Chocolate Institute (FCCI) and reviewed by the members of the ISCQF Working Group.*

## 17.2 Key specifications

**Table 35.** Key specifications for the sensory evaluation of cacao beans as unroasted coarse powder.

Parameter	Specification
Sample size from a 2kg representative sample	500g
Test sample size for a small uniform cacao bean lot	30–50 cacao beans
Particle size of coarse powder	0.5mm
Quantity of coarse powder for sensory evaluation	Half a teaspoonful (2.5ml)
Palate cleanser between sensory evaluation of a sample	Water at room temperature
Flavour attributes to be evaluated	Glossary of terms
Scale for intensity of flavour attributes and global quality	0–10

## 17.3 Equipment, tools and materials

The recommended tools and equipment for preparing and conducting a sensory evaluation of fermented, dried and unroasted cacao beans as coarse powder, are as follows:

- A popcorn popper (see Annexes, Figure 67) can be used if electricity is available. In cases where electricity is not available, a nutcracker (see Annexes, Figure 84) or a knife can be used.
- A grinder able to grind cacao beans to a particle size of 0.5mm without heating, such as an electric blade mill grinder with stainless steel blades (Annexes, Figure 85) or a manual burr mill grinder (Annexes, Figure 86).

- A container of 180–240ml (3/4 to 1 cup) sealed with a lid, food-safe and odourless in order to hold the sample during the sensory evaluation (Annexes, Figure 87). If the sample is not immediately assessed, keep the container sealed to preserve volatiles until an evaluation is performed.
- Spit and rinse cups.
- Water at ambient temperature (neither cold nor cooled) to rinse the palate between samples.
- A teaspoon with a standard capacity of 2.5ml.
- An evaluation form and a pen with unscented ink.
- A pair of tweezers.

## 17.4 Procedure

### 17.4.1 Sample preparation

This protocol involves handling unroasted cacao beans. Unroasted beans are a raw agricultural product that may contain pathogens, posing a food safety hazard if consumed. The coarse powder should not be tasted by individuals who are young, old, pregnant, or have weakened immune systems.

It is important to maintain good hand hygiene by washing hands frequently, especially before and after sample preparation and before and after sensory evaluation. If sample preparation is interrupted, hands should be washed again before resuming the process or handling the beans. Additionally, all tools and working surfaces should be cleaned and disinfected prior to processing. For further food safety recommendations, please refer to Chapter 3.

The following steps are recommended for sample preparation:

1. If the evaluation is conducted blind, a person other than the assessor should select the sample and assign a randomised three-digit blind code to the cacao bean sample. The processing can then be carried out by the assessor.
2. Either sample 500g from a 2kg representative sample or select 30–50 cacao beans randomly from a sample that has undergone physical quality and moisture content evaluation, as outlined in Chapter 7 'Determination of moisture content,' Chapter 8 'Physical evaluation of whole cacao beans,' and Chapter 9 'Physical evaluation of cut cacao beans'.



**NOTE:** 30–50 beans may be sufficient for the evaluation for a uniform and small lot. However, in order to obtain a statistically representative sample, 500g of beans should be obtained from quartering from the representative sample of 2kg, then ground and mixed for sensory evaluation (see Chapter 5 'Sampling bagged and bulk cacao beans').

3. Loosen the shells of the beans:
  - If electricity is available loosen the shells by puffing the beans in a popcorn popper (Annexes Figure 67) for a maximum of 60 seconds. Agitate the popper during this period to continuously minimise the heat exposure of the beans.
  - If electricity is not available, use a nutcracker (Annexes, Figure 84) to slightly crush the beans with and loosen the shells for an easier peeling. A knife can also be used to loosen the shells.
4. Peel the cacao beans with your fingers to obtain the nibs (shelled cacao beans). Collect them in a clean bowl and the shells in another bowl. Follow the protocol for winnowing manually for a quantity of 500g, Chapter 12 'Breaking and winnowing cacao beans'.
5. If shell fragments remain on some of the nibs, use the tweezers to remove (pick) them all.

6. Pour the shelled nibs into the grinder.
7. Grind the nibs into coarse powder with a particle size of around 0.5mm (this size can be inspected visually):
  - If using an electric grinder, process for 10 seconds while vigorously shaking the mill up and down to prevent clumping and to ensure that areas inside grinder that rise in temperature do not overheat the sample.
  - If using the burr grinder, turn the handle continuously until the particles are of a uniform size, approximately 0.5mm.
8. Label the odour-free container with the identification code for the sample. If the samples are to be blind assessed, use a randomised three-digit code (see Chapter 16 'General guidelines for sensory evaluation').
9. Pour the coarse powder into the odour-free container and close the lid until the sensory evaluation begins.



**NOTE:** Once ground into coarse powder, the sample should be in a sealed container and evaluated immediately. If stored for a successive evaluation, the sample should be kept in a tightly sealed container and the time lapse between sample preparation and sensory evaluation should not exceed three hours. The ground beans should not be stored in a fridge or freezer during this time as condensation may occur and freezing may alter the flavour profile. If samples need to be stored over a longer period, store whole beans and prepare the coarse powder shortly before the sensory evaluation.

### 17.4.2 Sensory evaluation

The following steps are recommended for the sensory evaluation of unroasted cacao beans ground in coarse powder:

1. Gently stir or tumble the coarse powder sample while placing the nose over the open container.
2. Assess the aroma of the sample and record any observations in the comments section of the evaluation form (access the form in Section 20.3).
3. Place a half teaspoonful (2.5ml) of the sample on the tongue and hold it in the mouth for the necessary duration needed to score the attributes, moving it across the palate. Do not chew.
4. Inhale tiny amounts of air through the mouth, as if sipping, and exhale through the nose to allow the aroma and flavour to become fully apparent.
5. In the mouth, notice the different attributes that become apparent at three contiguous time intervals: (1) the initial, (2) middle and (3) residual end flavour notes. Some flavours appear or disappear very quickly or are easily masked, while others can linger with a distinct aftertaste. The order or appearance of these notes varies from sample to sample.
6. While the different attributes are becoming apparent, evaluate the flavour of the coarse powder using the attributes and the intensity scale between 0 to 10 (refer to Table 38 in Chapter 20). The appearance and perception of flavour attributes may not necessarily align with the order listed on the form. Any attribute can become noticeable at the beginning or middle stages and then fade away. Evaluate the intensity of the attributes in the order they appear and are perceived, using a scale of 0-10, while keeping in mind the scale's defined meaning in the Glossary of Terms.



**NOTE:** The flavour attributes are divided into three groups:

**Core attributes:** Cacao, acidity, bitterness and astringency that are expected to be present in every cacao sample and scored.

**Complementary attributes:** Characteristics that may or may not be perceived in a cacao sample.

**Off-flavours:** Resulting from defects that may or may not be perceived in a cacao sample.

7. Once the sample is characterised, score the global quality between 0 and 10. The meaning of the scale is explained in Section 20.2, Table 39.
8. Spit out the coarse powder and saliva bolus into a spitting cup for this purpose.
9. Pay attention to the flavours that may be present in the finish and aftertaste and modify or review your scoring accordingly.
10. In the comments section, include any additional observations about the sample that have not been mentioned elsewhere. This includes any specific recommendations for the cacao producer, especially if there are notable observations related to the fermentation and drying process.
11. Thoroughly rinse the palate with water at ambient temperature (avoid cold or cooled water) and spit the rinse water into a cup for this purpose. Repeat as necessary, particularly in cases of significant off-flavours.
12. Note any general comments about the sample.
13. Take a break if you experience palate overload or carry-over effect.
14. Proceed with the next sample.



# Ch 18. Sensory evaluation of cacao beans as cacao mass

## 18.1 Objective

This protocol outlines the procedure for conducting sensory evaluation to assess the flavour attributes and global quality of fermented, dried and roasted cacao beans processed into mass without any additional ingredients. The primary objective is to generate one of two types of distinct sensory flavour profiles (based and adapted from ISO 13299):

- **Quantitative sensory flavour profile:** obtained by the statistical analysis of data generated by several assessors (panel) evaluating the same samples and flavour attributes.
- **Consensus sensory flavour profile:** obtained through a discussion and agreement by a group of assessors (panel) evaluating the same samples and flavour attributes after individual evaluation see Section 20.4.2 'Considerations on sensory profiling obtained by consensus'.

## 18.2 Key specifications

**Table 36.** Key specifications for the sensory evaluation of cacao beans as cacao mass.

Parameter	Specification
Quantity of cacao mass for evaluation per tasting	1–2g
Characteristics of the container for the cacao mass sample	Odour-free, 28ml cup with lid
Temperature of the cacao mass sample at the time of sensory evaluation	Melted at 48–50°C (118–122°F)
Maximum time that the sample should be at 48–50°C (118.4–122°F) heated only once i.e. not reheated	5 minutes
Palate cleanser between sensory evaluation of a sample	Non-yeast, unsalted and flavourless water crackers and warm water at 40–50°C (104–122°F)
Minimum number of assessors (members) in a sensory evaluation panel for quantitative sensory profiles (based on data analysis)	6
Minimum number of assessors (members) in a sensory evaluation panel for conventional sensory profiles (agreed final values)	4
Maximum number of cacao mass samples tasted during an evaluation session	6
Minimum number of known reference cacao mass samples tasted prior to each evaluation session for calibration purposes	2
Replicates: number of times each cacao mass is evaluated (minimum)	2
Minimum blind known cacao mass samples per evaluation session in absence of replicates	1
Flavour attributes (core and complementary) to be evaluated	Glossary of terms
Scale for intensity of flavour attributes and global quality	0–10

## 18.3 Equipment, tools and materials

### 18.3.1 Cacao mass samples

- For the production of cacao mass see Chapter 13 'Refining cacao nibs into mass'.
- The cacao mass samples should be stored as solid mass in jars (Annexes, Figure 88), as bars, or in portion-size drops (Annexes, Figure 89) inside a sealed container or bag. The jars, bags or containers must be odour-free and not permeable to moisture nor oxygen and avoid loss of aromas. Samples can be frozen in a deep-freezer at approximately  $-18^{\circ}\text{C}$  ( $-0.4^{\circ}\text{F}$ ) for long-term storage (more than a year), or kept in a refrigerator at approximately  $4^{\circ}\text{C}$  ( $39^{\circ}\text{F}$ ) or in a room at approximately  $15^{\circ}\text{C}$  ( $72^{\circ}\text{F}$ ) for up to a year if the temperature is maintained.
- For sensory evaluation, each assessor should be provided with 1-2g of the cacao mass sample to be evaluated (doubled if tasted twice). The samples to be evaluated include:
  - » Unknown cacao mass samples with unknown flavour profiles.
  - » Reference cacao mass samples with known flavour attribute scores for calibration.
  - » Blind control cacao mass samples in case no replicates are available.



**NOTE:** Depending on the number of assessors and samples per evaluation session, plan for the total amount of samples to be heated.

- It is recommended to evaluate a maximum of 12 unknown cacao mass samples per day, with a maximum of 6 samples per session. These numbers can be adjusted based on the assessors' experience, such as dividing them into two sessions of 6 samples or three sessions of 4 samples. The time intervals between sessions will depend on meal times and other food-related breaks. It is important not to conduct sensory evaluation immediately after a meal.
- For calibration purposes, it is advised to evaluate two reference cacao mass samples per session before assessing the unknown samples. The first reference sample should have a high cacao intensity, while the second sample can be chosen randomly or selected to match the expected flavour profile of the unknown samples if information about the region or country is available.
- If possible, it is recommended to evaluate each unknown cacao mass sample at least twice (two replicates) during different evaluation sessions to account for individual variation.
- To monitor an assessor's performance, it is suggested to include a blind control sample in several evaluation sessions.

### 18.3.2 Equipment and tools for cacao mass sample preparation

The suggested equipment and tools for preparing the cacao mass samples are as follows:

- For serving the cacao mass samples, it is recommended to use 28ml odour-free soufflé cups with lids (refer to Annexes, Figure 90). These cups should be made of food-grade material and should be heat-resistant to at least  $50^{\circ}\text{C}$  ( $122^{\circ}\text{F}$ ). Ideally, C-pet (Crystalline Polyethylene Terephthalate), polystyrene, or polypropylene plastic cups are recommended. However, glass or any other reusable material can also be used as long as they meet these specifications.



**NOTE:** To test if the containers are odour-free, place a number of cups in an odour-free glass container, seal it, warm it to  $50^{\circ}\text{C}$  ( $122^{\circ}\text{F}$ ) and hold it for one hour. Open the lid and smell the contents. If no odours are smelled, then the cups are odour-free.

- Adhesive labels and odour-free fine point permanent marker to label the cups.
- Top-loading weighing scales with an accuracy of 0.1g.
- Temperature-controlled heating equipment such as dry-bath incubator (Annexes, Figure 91), heating block, warming plate (Annexes, Figure 92), oven with trays (Annexes, Figure 94a), food dehydrator (Annexes, Figure 94b), or bain-marie (Annexes, Figure 94c).
- A non-contact infrared thermometer (0–100°C or 32–212°F) to measure cacao mass temperature (Annexes, Figure 73).
- A digital timer.
- A serrated knife and cutting board for cutting the solid cacao mass samples or a spoon or spatula to dig out the cacao mass out of a jar (Annexes, Figure 88 and Figure 89). It is important to avoid scraping in order to get enough cacao mass that was not exposed to the surface.
- A list of the serving sequence (three-digit codes generated randomly) of cacao mass samples for the evaluation session (see Chapter 16 'General guidelines for sensory evaluation').

## 18.4 Procedure

### 18.4.1 Preparation of the cacao mass samples

1. Clean and disinfect all working tools and surfaces using suitable cleaning agents and disinfectants. When cleaning tasting spoons and spatulas, use disinfectant or soap carefully that are completely free of odours. Allow them to air dry and air out to ensure the area is odour-free.
2. Gradually bring the cacao mass samples to room temperature after removing them from cold storage. If they were stored in the freezer, transfer them to the refrigerator for 24 hours before allowing them to reach room temperature.
3. Arrange all tools to be used by each assessor at their individual stations or sensory evaluation booths (refer to Figure 17).
4. Check the appearance of the cacao mass samples to be assessed to ensure they were properly solidified and are not stratified (see Chapter 13 'Processing cacao nibs into mass'). Stratified samples look whitish at the top, and increase in darkness towards the bottom. Stratification occurs when the cooling speed of melted cacao mass is slowed before it solidifies. The cacao butter remains liquid for longer allowing the tiny solid particles to sediment. Sedimentation increases the concentration of solids at the bottom. Consequently, the composition and the flavour are not homogeneous in the sample. Before portioning stratified samples, remelt the sample at no more than 45–50°C (113–122°F) and mix well to homogenise, then resolidify quickly to avoid stratification.
5. Prepare the portions of cacao mass:
  - a. If the cacao mass is solidified inside a jar (Annexes, Figure 88), use a spatula to dig out a vertical section of the desired amount of solid cacao mass needed considering a portion of 1–2g for each assessor. Wipe the spatula clean with a fragrance-free paper towel in between portioning out the various cacao mass samples.
  - b. If the cacao mass is solidified as individual portions or drops (Annexes, Figure 89), select the required number of drops and portion them out with a spoon or spatula, considering a portion of approximately 1–2g per assessor. Clean the spoon or spatula with a fragrance-free paper towel in between portioning out the various cacao mass samples.
  - c. If the cacao mass is solidified as blocks or bars (Annexes, Figure 89), cut them into chunks

using a serrated knife and cutting board, considering a portion of approximately 1–2g per assessor. Clean the knife and cutting board with fragrance-free paper towel in between portioning out the various cacao mass samples.

6. Label the cups with the randomized three-digit codes (Annexes, Figure 90). The label should be adhesive and securely fixed to the cup and the lid or the code written directly on the cup and the lid with an odour-free fine point permanent marker.
7. Put 1–2g of each cacao mass sample into the corresponding labelled cup (check that the sample corresponds to the code on the cup) and close the lid tightly on each sample.
8. Organise the cups with close lids with the cacao mass in groups according to the serving sequence (see Chapter 16 'General guidelines for sensory evaluation'). The first group of samples to be melted should be the first ones to be evaluated, specifically, the known reference cacao mass samples used for palate calibration.



**Figure 17.** a) Sensory evaluation booth equipped with samples, printed evaluation form, spatula and water thermos b) with heating equipment; and c) with heating equipment and computer with evaluation form (Bioversity International, Archila, 2022).

### 18.4.2 Melting cacao mass samples and serving assessors

The optimal temperature range for sensory evaluation of cacao mass is 48–50°C (118–122°F). This temperature range ensures the best expression of flavour and minimises differences among samples caused by inconsistent or uncontrolled crystallisation. It is important to set a specific temperature and time for heating the samples to ensure they are heated enough to allow for the optimal expression of core and complementary attributes, while also avoiding volatilisation and loss of delicate complementary attributes. This approach helps minimise variations in the sensory evaluation process.

The heating equipment should be set within the temperature range of 45–52°C (113–125°F). However, it is crucial to ensure that the cacao mass sample being evaluated remains within the range of 48–50°C (118–122°F). The sample should be fully melted, but it should not be heated for more than five minutes after reaching the desired temperature. It is important to avoid reheating or prolonging the heating process, as this can result in the loss of aromatic flavours due to re- or overheating.



**NOTE:** Use only the quantity needed and reseal the rest of the solid cacao mass sample to minimise air exposure, evaporation and the oxidation of the samples aromas.

The melting time for any given sample is dependent on many factors. These include:

- Inherent hardness or melting point of the cacao butter occurring naturally in the cacao mass.
- Sample size, e.g. 1g melts faster than 2g.
- Type of cups used, the material and its thickness.
- Contact of the bottom of the cups with the base of the heater.

It is recommended to conduct a few trials in advance of the sensory evaluation to find the total time needed to fully melt the samples with the specific heating equipment to be used and within the given environment. Take note of this time.

The steps for melting samples and serving one sample at a time are as follows:

1. Set the temperature of the heating equipment to uniformly melt the samples at 48–50°C (118–122°F).
2. Close the lid or door of the heating chamber to enhance thermal efficiency.
3. Once the heating chamber has reached the set temperature, open the lid or door and place the first cup or group of cups with cacao mass into the heating equipment.
4. Heat the samples until fully melted (duration specified in the trials). Avoid heating for more than five minutes after reaching 48–50°C (118–122°F).
5. Check the temperature of the samples before serving, using a non-contact infrared thermometer pointed at the closed cup, which provides a reliable estimate of the cacao mass temperature. Avoid opening the cups to prevent loss of aromas.
6. Confirm that the assessors are ready to begin the sensory evaluation.
7. Remove the melted samples in the cups from the heating equipment.
8. Serve the samples in the cups to the assessors and instruct them to start the sensory evaluation immediately, following the steps outlined in Section 18.4.3 'Flavour evaluation of cacao mass samples'.
9. While the assessors are evaluating the first group of samples, insert the next group of cups containing the samples into the heating equipment.
10. Repeat steps 3 to 9 until all the samples have been melted and assessed.

It is possible to reduce the time between successive evaluations by staggering the melting of samples (refer to Figure 18 and Figure 19 below) and synchronising it with the evaluation process. However, the evaluation time for each sample should not be arbitrarily set, as it can vary depending on several factors, including:

- Time interval needed by the assessors to evaluate one sample, i.e. less experienced assessors may take longer than more experienced assessors.
- The number of attributes to be scored and the written descriptions for each sample.

An example of staggered melting of samples is described in the Figure 18 and illustrated in Figure 19.

### Example of steps for staggering the melting of samples:

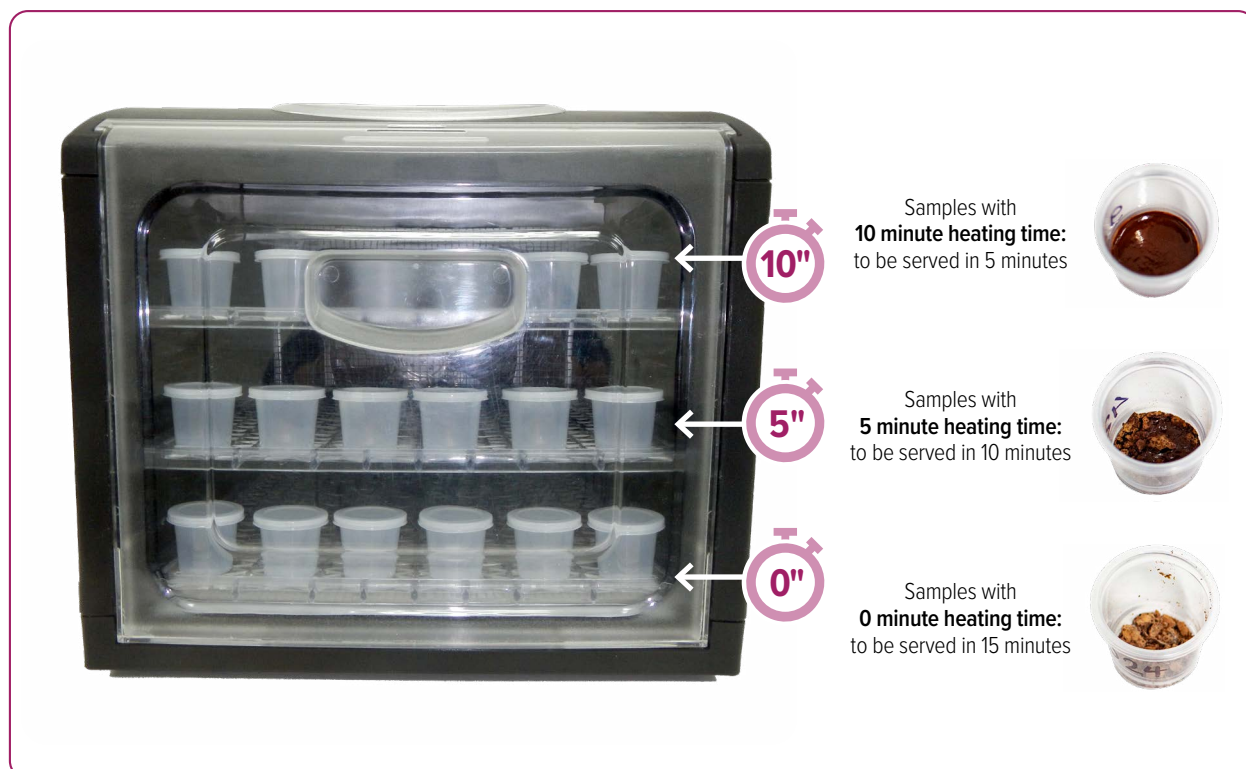
- Five-minute interval per sample
- Three groups of samples in the heating equipment
- Fifteen minutes of melting time per sample before evaluation

#### Steps:

1. Set the temperature of the heating equipment to heat the samples uniformly to 48–50°C (118.4–122°F).
2. Close the lid or door of the heating chamber for better thermal efficiency.
3. Put the first group of samples in cups into the heating equipment.
4. After 5 minutes place the second group of samples in cups into the heating equipment.
5. After 10 minutes, place the third group of samples in cups into the heating equipment.
6. After 15 minutes, take the first group of samples in the cups out of the heating equipment and insert the fourth group of samples. If needed, the second and third groups can be moved up inside the heating chamber.
7. Serve the first group of samples in cups to the assessors.
8. While they are assessing the first samples, insert the next group of samples in cups into the heating equipment.
9. Repeat this procedure (Steps from 3 to 9) until all samples have been assessed.

For example, for three groups of samples with a six-minute tasting interval, melting time per sample would be 18 minutes. However, for a seven or eight-minute tasting interval, two groups of samples should be in the heating equipment for a melting time of 14–16 minutes per sample. In this case, the temperature may need to be adjusted up to  $\pm 2^{\circ}\text{C}$  to ensure that the samples are just melted per specification. The specific melting time should be identified in the trials as it will depend on the heating equipment, the material of the cups and the environmental conditions.

**Figure 18.** Example of steps for staggering the melting of samples.



**Figure 19.** Example of heating stages of cacao mass samples when serving to a panel (using a food dehydrator). (Dolores Alvarado/ Bioversity International).

### 18.4.3 Flavour evaluation of cacao mass samples

1. Clearly explain the objective of the specific sensory evaluation to all assessors.
2. Ensure that the assessors are trained on the flavour attributes to be assessed and the sensory evaluation procedure being employed.
3. The first sample to be evaluated should be a known reference cacao mass sample for calibration with evaluation data obtained from a calibrated panel. Check that it is labelled as such, and that evaluation data is available.
4. Check that the three-digit code of the cacao mass sample to be evaluated corresponds to the matching code on the evaluation form see (Chapter 20 'Tools for sensory evaluation').
5. Place the cup with the melted cacao mass close to the nose, then remove the lid.
6. After clearing your nostrils by breathing out, take several inward sniffs to sense the aroma present in the head space of the cup. Deeply smell the sample immediately while simultaneously mixing it with the tasting spatula.
7. Record any observations about the aroma in the comments section in the evaluation form (see Chapter 20 'Tools for sensory evaluation').
8. Scoop approximately 0.75–1g (1ml) of melted cacao mass onto the tasting spatula.
9. Spread the cacao mass on the tongue, hold it in the mouth for the time necessary to score the attributes, slowly rubbing the tongue against the roof of the mouth.
10. Inhale tiny amounts of air through the mouth, as if sipping, and exhale through the nose to allow the aroma and flavour to become fully apparent. Only inhale small sips of air.
11. In the mouth, notice the different attributes that become apparent at three contiguous time intervals: (1) the initial, (2) middle; and (3) residual end flavour notes. Some flavours appear or disappear very quickly or are easily masked, while others linger with a distinct aftertaste. The sequence in which these notes manifest themselves may vary from one sample to another.
12. While the different attributes become apparent, evaluate the flavour of the cacao mass using the attributes and the intensity scale between 0 to 10 defined in the 'Glossary of Terms' (Chapter 20 'Tools for sensory evaluation'). The appearance and perception of flavour attributes may not necessarily follow the order specified in the 'Glossary of terms' or the evaluation form. Any attribute, regardless of its category (core, complementary, off-flavours), can become apparent during the initial or middle-time intervals and may subsequently disappear.



**NOTE:** In the 'Glossary of terms', the flavour attributes are divided into three groups:

**Core attributes:** Cacao, acidity, bitterness, astringency and roast degree expected to be present in every sample and should always be scored.

**Complementary attributes:** Characteristics that can be perceived but not always found in every sample.

**Off-flavours:** Defects that may be present in the cacao mass sample.

13. Once the flavour profile of the samples has been documented, evaluate its global quality on a scale of 0–10, based on the meaning described in Chapter 20 'Tools for sensory evaluation'.
14. Spit out the cacao mass and saliva bolus into the provided spitting cup.
15. Pay attention to any flavours present in the finish and aftertaste and adjust or revise your scores accordingly.
16. In the comments section, include any additional observations about the sample that have not been noted elsewhere, including any recommendations for the cacao producer, particularly regarding the fermentation and drying process.

17. Proceed with cleansing the palate to prepare for the evaluation of the next sample.

#### **18.4.4 Palate cleansing**

To clean the palate between each cacao mass or chocolate sample, follow these steps:

1. Rinse the mouth with warm water around 40–50°C (104–122°F) swilling vigorously.
2. Spit the rinse water into a spit cup designated for this purpose.
3. Chew a small piece of a non-yeast, unsalted and flavourless water cracker (approximately 2×2cm) with the front teeth only (do not use molars as the crackers may get stuck in the teeth and become difficult to dislodge). Move the crumbs around with the tongue to pick up cacao mass particles and swallow.
4. Rinse the mouth again with warm water and spit out (rinse forwards).
5. Rinse the mouth for the third time with warm water, but this time swallowing (rinse backwards).
6. Repeat any steps of the rinsing sequence if a sample is particularly persistent due to some defect or intense attribute.
7. Keep the mouth closed to stabilise temperature and normal saliva function in the mouth, for 2–3 minutes.

#### **18.4.5 Considerations for sensory evaluation of solid cacao mass**

Cacao mass can also be evaluated for flavour in its solid form, whether tempered or not, melted at an uncontrolled temperature, or taken directly from the refining process. This allows for convenient assessment of flavour and consistency within an organisation or company. However, it is important to note that evaluating solid cacao mass introduces variations that can compromise reproducibility across organisations. These variations include differences in flavour expression due to uncontrolled crystallisation.

To minimise variations and ensure consistent evaluation, the sample of solid cacao mass should be well-tempered, equilibrated at room temperature, moulded into any thin shape of about 4g.

The following steps are recommended for evaluating solid cacao mass:

1. Place a small piece of solid cacao mass (approximately 2g or half a piece) on the tongue.
2. Position the cacao mass pieces between the tongue and the palate.
3. Chew the cacao mass two or three times with the mouth closed, but do not swallow.
4. Allow the sample to melt completely.
5. Perceive the flavours as they appear and record the evaluation using the attributes and the intensity scale between 0 to 10 defined in the 'Glossary of Terms' (Chapter 20 'Tools for sensory evaluation').
6. Cleanse your palate as described earlier.
7. Specify in the documentation of results that the cacao mass sample was evaluated in its solid form, so that the results can be interpreted accordingly.

# Ch 19. Sensory evaluation of cacao beans as dark chocolate

## 19.1 Objective

This protocol describes the process of conducting sensory evaluation of fermented, dried and roasted cacao beans processed into a dark chocolate, in order to describe the flavour attributes and global quality.

## 19.2 Key specifications

**Table 37.** Key specifications for the sensory evaluation of cacao beans as dark chocolate.

Parameter	Specification
Quantity of dark chocolate for evaluation per tasting	2–3g
Temperature of the dark chocolate sample at the time of sensory evaluation	Room temperature
Palate cleanser between sensory evaluation of a sample	Non-yeast, unsalted and flavourless water crackers and warm water at 40–50°C (104–122°F)
Flavour attributes (core and complementary) to be evaluated	Glossary of terms
Scale for intensity of flavour attributes and global quality	0–10

## 19.3 Equipment, tools and materials

### 19.3.1 Dark chocolate samples

- For the production of dark chocolate see Chapter 13, 'Processing cacao nibs into mass' and Chapter 14, 'Processing cacao mass into dark chocolate'.
- The dark chocolate samples should be stored properly, ensuring they are well crystallised. They should be kept inside a sealed container or bag that is both odour-free and impermeable to moisture and oxygen. This will help prevent any loss of aromas and maintain the quality of the samples.
- It is recommended to evaluate a maximum of 12 chocolate samples per day, with no more than six samples in a single session. These numbers can be adjusted based on the assessors' experience. For instance, they can be divided into two sessions of six samples or three sessions of four samples. The timing between sessions should take into account meal times and other food-related breaks. It is important to note that sensory evaluation should not be conducted immediately after a meal.

### 19.3.2 Equipment and tools for cacao mass sample preparation

- Small plates or cups for serving the dark chocolate samples.
- Warm water (avoiding chlorinated tap water or water with added salts) to rinse the mouth between tastings, kept in a thermos capable of maintaining the water at 40–50°C (104–122°F) for at least 2+ hours (or the length of the evaluation session) (Annexes, Figure 93).
- Spit and rinse cups in a tasting booth.
- An evaluation form and odour-free pen or computer for recording results.

- Non-yeast, unsalted and flavourless water crackers, for palate cleansing in-between samples.
- Paper napkins.
- The Glossary of terms, containing a scale of intensity and meanings to use as references to score flavour attributes for the chocolate sensory evaluation.

## 19.4 Procedure

### 19.4.1 Preparation of the dark chocolate samples

1. Bring the chocolate samples to room temperature. If the samples are stored in a cold room, take them out one hour prior to the evaluation. In the case of samples stored in the freezer, transfer them to the fridge overnight and then allow them to reach room temperature for an hour before evaluation.
2. Cut the chocolate into 5g pieces and place them on the plates or cups to be served, previously labelled with the sample ID (three-digit-codes).
3. Order the chocolates in the right serving order.

### 19.4.2 Flavour evaluation of the dark chocolate samples

1. The first sample to be evaluated should be a known reference dark chocolate sample for calibration.
2. Check that the three-digit code of the dark chocolate sample to be evaluated corresponds to the matching code on the evaluation form.
3. Break the chocolate piece into 2 pieces.
4. Take one piece and place it close to the nose.
5. Deeply smell the sample whilst simultaneously rubbing its surface with the fingers.
6. After clearing the nostrils by breathing out, take several inward sniffs to sense its aroma.
7. Record any observations about the aroma in the comments section in the evaluation form.
8. Bite a piece of the dark chocolate and place it between the tongue and the palate.
9. Let the chocolate melt while rubbing with the tongue against the roof of the mouth.
10. Once it starts melting, spread the dark chocolate on the tongue and hold it in the mouth for the time necessary to score the attributes.
11. Inhale tiny amounts of air through the mouth, as if sipping, and exhale through the nose to allow the aroma and flavour to become fully apparent. Only inhale small sips of air.
12. In the mouth, notice the different attributes that become apparent at three contiguous time intervals: (1) the initial, (2) middle and (3) residual end flavour notes. Some flavours appear or disappear very quickly or are easily masked, whilst others could linger with a distinct aftertaste. The order of appearance of these notes varies from sample to sample.

While the different attributes are becoming apparent, evaluate the flavour of the dark chocolate using the attributes and the intensity scale between 0 to 10 defined in the 'Glossary of terms'.

Appearance and perception of the attributes will not necessarily follow the order in the 'Glossary of terms'. Any of the attributes, regardless of the group they belong to (core, complementary, off-flavours) may become apparent in the initial or middle-time intervals and disappear.



**NOTE:** In the 'Glossary of terms', the flavour attributes are divided into three groups:

**Core attributes:** Cacao, acidity, bitterness, astringency and roast degree expected to be present in every cacao sample and scored.

**Complementary attributes:** Characteristics that can be perceived but not always found in every sample.

**Off-flavours:** Resulting from defects that may or may not be present in the cacao sample.

13. Score the intensity of the attributes in order of appearance and perception in a scale of 1–10, considering the meaning of the scale.
14. Once the sample is characterized for its flavour, score the global quality between 0 and 10 using the scale and its meaning explained in the Glossary of terms found in Chapter 20, 'Tools for sensory evaluation'.
15. If needed, spit out the chocolate and saliva bolus into a spitting cup provided for this purpose.
16. Pay attention to the flavours that may be present in the finish and aftertaste and modify or review your scoring accordingly.
17. In the comments section, include any additional observations about the sample that are not noted elsewhere including any recommendations for the cacao producer, if anything is noted that relates to the fermentation and drying process.
18. Proceed with cleansing the palate to prepare for the evaluation of the next sample.

### 19.4.3 Palate cleansing

To clean the palate between each chocolate sample, follow these steps:

19. Rinse the mouth with warm water around 40–50°C (104–122°F) swilling vigorously.
20. Spit the rinse water into a spit cup designated for this purpose.
21. Take a small piece of non-yeast, unsalted and flavourless water cracker, approximately 2x2cm in size, and chew it using only the front teeth. Avoid using the molars, as the crackers may get stuck and be difficult to remove. Use the tongue to move the crumbs around the mouth, allowing them to pick up any chocolate particles. Afterward, swallow the mixture.
22. Rinse the mouth again with warm water and spit out (rinse forwards).
23. Rinse the mouth for the third time with warm water, but this time swallowing (rinse backwards).
24. Repeat any steps of the rinsing sequence if a sample is particularly persistent due to some defect or intense attribute.
25. Keep the mouth closed to stabilise temperature and normal saliva function in the mouth, for a period of 2–3 minutes.



## Ch 20. Tools for sensory evaluation

To ensure comparability of results, it is essential to have a common vocabulary and a set of tools that guide the sensory evaluation and recording process. These tools play a crucial role in providing valuable insights into the sensory attributes of a product. Manufacturers, marketers, and researchers can then utilise these insights to enhance the quality and appeal of the product to consumers. This chapter delves into the various tools employed in sensory evaluation. The tools are as follows:

- **Flavour Wheel:** This tool provides a quick and comprehensive overview of a shared vocabulary for flavour attributes and their sub-attributes. It assists in standardising the terminology used during evaluations.
- **Glossary of terms:** A collection of terms with definitions of flavour attributes and sub-attributes. This resource aids in understanding and assessing the intensity of flavours and the global quality of the product.
- **Sensory Evaluation Form:** This form is designed to record the flavour attributes and their intensity scores, global quality assessments, and any additional comments that may be useful for communication with the producers of the cacao bean samples and any users of the product.
- **Tools for Analysis and Visualisation:** These tools enable the analysis and visualisation of flavour evaluations, helping to create a flavour profile for the product.
- **Additional Documentation Guidelines:** This section provides further guidance on documentation practices, ensuring that evaluations are thorough, consistent, and properly documented.

By utilising these tools, sensory evaluations can be conducted in a standardised and systematic manner, allowing for meaningful comparisons and facilitating communication among stakeholders.

### 20.1 Flavour wheel

A flavour wheel serves as a standardised tool for describing and evaluating flavours, and it exists for various food commodities, including coffee, wine, and olive oil. Its purpose is to facilitate consistent and objective communication and comparison of sensory attributes. By utilising a flavour wheel, consumers, producers, and researchers can effectively identify and describe specific attributes such as acidity, bitterness, fruitiness, spiciness, and other subtle nuances that contribute to the overall sensory experience. This shared vocabulary enhances the understanding and evaluation of flavours in a coherent and structured manner.

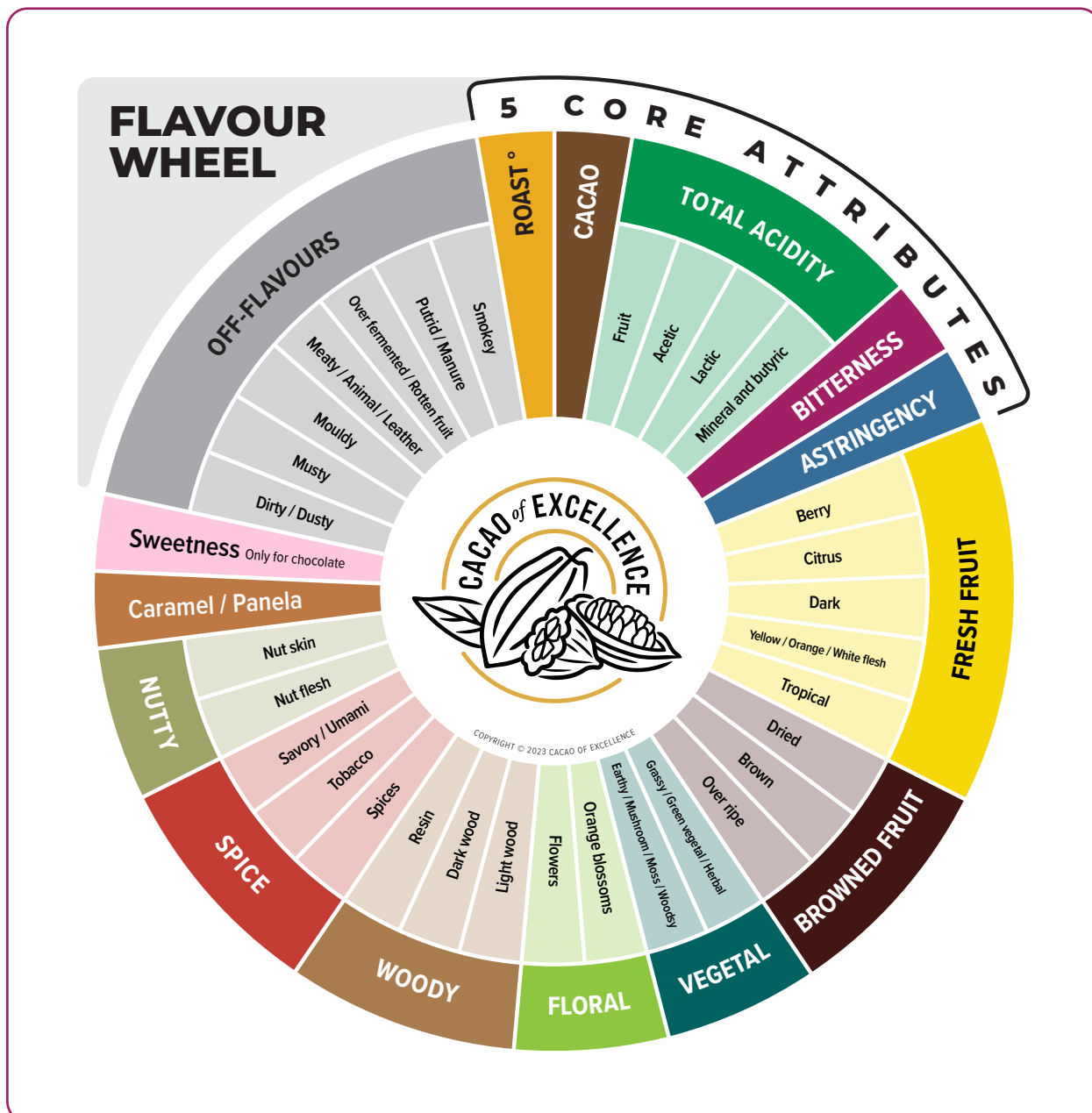
The Cacao of Excellence programme developed a flavour wheel (Fig. 20) based on its 12 years of experience evaluating cacao samples from around the world for its Awards competition. Its development involved the collective input of experts in sensory evaluation and in the processing of finished products.

The flavour attributes are divided into three groups:

**Core attributes:** Flavour characteristics expected to be present in every cacao. They include cacao, acidity, bitterness, astringency, and roast degree.

**Complementary attributes:** Flavour characteristics that may or may not be perceived in cacao samples. These complementary attributes are described as fresh fruit or browned fruit, vegetal, floral, woody, spice, nutty, and caramel/panela. In the case of dark chocolate, sweetness is also included.

**Off-flavours:** Characteristics that result from defects and may or may not be perceived in the cacao samples.



**Figure 20.** Cacao of Excellence Flavour Wheel (2023).

## 20.2 Glossary of terms for sensory evaluation

A glossary of terms is a valuable resource that provides a list of flavour attributes along with their definitions.

These flavour attributes and sub-attributes are categorized into core attributes, complementary attributes, and off-flavours. Each of these attributes is assessed using an intensity scale ranging from 0 to 10. The glossary also includes examples of intensity scores (references) to assist evaluators in understanding and applying the scale accurately.

Furthermore, a global quality score is defined, providing a comprehensive assessment of the overall quality of the sample. Table 39 presents a description of each score ranging from 0 to 10, aiding in the interpretation and communication of the sample's evaluation.

**Table 38.** Cacao of Excellence Glossary of terms for sensory evaluation of cacao beans processed into mass and dark chocolate (Cacao of Excellence 2023).

### Attribute intensity scale and meanings:

#### Intensity Meaning

0	Absent.
1	Just a trace and may not be found if tasted again.
2	Present in the sample but at low intensity.
3 to 5	Clearly characterising the sample.
6 to 8	Dominant characterisation of the sample.
9 to 10	Maximum. Strong intensity. Overpowers some other flavour notes in the sample.

### The flavour attributes are divided into three groups:

- 1. Core attributes:** cacao, acidity, bitterness, astringency and roast degree expected to be present in every sample and scored.
- 2. Complementary attributes:** characteristics that may or may not be perceived in cacao samples.
- 3. Off-flavours:** resulting from defects that may or may not be perceived in cacao samples.

#### Descriptor

#### Description

#### Intensity level / Reference notes

<b>Cacao</b>	Typical flavour of roasted cacao beans that are well fermented, dried, free of defects.	0–2	Under-fermented cacao, ancient Criollos.
		3–5	Appropriately fermented “Nacional” and Papua New Guinean lots.
		6–8	Appropriately fermented cacao, some West African and some Dominican Republic Hispaniolan lots.
		9–10	Some West African lots.
<b>Acidity</b>	<p><b>Total acidity</b> is the sum of the following individual acidities:</p> <ul style="list-style-type: none"> <li>• <b>Fruit:</b> citric or other fruit acids.</li> <li>• <b>Acetic:</b> vinegar (can be smelled in the sample).</li> <li>• <b>Lactic:</b> typically occurring in sour milk and yogurt</li> <li>• <b>Mineral and butyric:</b> harsh metallic tasting (mineral) and rancid butter (butyric).</li> </ul> <p>Perception of acidity intensity is particularly dependent on the amount of sample in the mouth.</p>	0–2	Some well-prepared West African lots.
		3–5	Some Ecuadorian, Peruvian and Central American lots.
		6–8	Some Dominican Republic Hispaniolan, Papua New Guinean and Malaysian lots.
<b>Bitterness</b>	<p>Basic taste, typically perceived in caffeine, coffee, kola nut, some beers and grapefruit.</p> <p>Perception of acidity intensity is particularly dependent on the amount of sample in the mouth.</p>	1–2	Some ancient Criollos.
		3–5	Well-prepared West African lots.
		6–8	Severely under- and un-fermented cacao.

Descriptor	Description	Intensity level / Reference notes	
<b>Astringency</b>	<p>Astringency could be perceived in two ways:</p> <ul style="list-style-type: none"> <li>• <b>Sharp mouth-drying effect</b>, sharp, perceived between tongue and palate and /or at the back of the front teeth and inside lips and gums – typical of raw nut skins and green banana skins.</li> <li>• <b>Velvety sensation</b> on the sides of mouth and tongue. Typical of tannins in some wines or beers.</li> </ul> <p>Perception of astringency intensity is particularly dependent on the amount of sample in the mouth.</p>	<b>I N T E N S I T Y</b>	<p>1–2 Some ancient Criollos.</p> <p>3–5 Normal intensity for most cacao.</p> <p>6–8 -</p> <p>9–10 -</p> <hr/> <p>Sharp-mouth drying Typical of under-fermented cacao.</p> <p>Velvety Typical of appropriately fermented “Nacional”.</p>
<b>Fresh fruit</b>	<p><b>Total fresh fruit</b> is composed of the following sub-attributes:</p> <ul style="list-style-type: none"> <li>• <b>Berry</b>: red or black currant, strawberry, raspberry, blackberry, acai berry.</li> <li>• <b>Citrus</b>: orange, lemon, lime, grapefruit or generic sensation of citrus-like fruit.</li> <li>• <b>Dark</b>: cherry, plum.</li> <li>• <b>Yellow / orange / white flesh</b>: apricot, peach, pear, banana.</li> <li>• <b>Tropical</b>: passion fruit, pineapple, mango or soursop.</li> </ul>		<p>0–2 Many West African lots.</p> <p>3–5 Some Central and South American, well fermented Asia and Pacific country lots.</p> <p>6–7 Madagascar, some Central and South American country lots, some Papua New Guinean lots.</p>
<b>Browned fruit</b>	<p><b>Total browned fruit</b> is composed of the following sub-attributes:</p> <ul style="list-style-type: none"> <li>• <b>Dried</b>: dried apricot, banana, yellow raisin, fig that has undergone an un sulphured drying process.</li> <li>• <b>Browned</b>: dark raisin, dates, prune.</li> <li>• <b>Over ripe</b>: No longer fresh and severely over-ripe fruit, turning brown inside and outside, as a step towards over-fermentation.</li> </ul>		<p>0–2 Many West African lots.</p> <p>3–5 Fully fermented Indonesian and some Caribbean country lots.</p> <p>6–8 Some Papua New Guinean and some Caribbean country lots.</p>
<b>Vegetal</b>	<p><b>Total vegetal</b> is composed of the following sub-attributes:</p> <ul style="list-style-type: none"> <li>• <b>Grassy / Green vegetal / herbal</b>: <ul style="list-style-type: none"> <li>» Grassy – freshly cut grass, young green leaves.</li> <li>» Green vegetal – crushed mature leaves.</li> <li>» Herbal – hay, straw or herbal / dried green, herbs like thyme and rosemary.</li> </ul> </li> <li>• <b>Earthy / mushroom / moss / woody</b>: <ul style="list-style-type: none"> <li>» Earthy – smell of dampness rising from soil after rain.</li> <li>» Mushroom – smell of fresh mushrooms.</li> <li>» Moss – damp moss often associated with earthiness.</li> <li>» Woody – leaves and wood on a forest floor.</li> </ul> </li> </ul>		<p>0–2 West African lots.</p> <p>3–5 Appropriately fermented “Nacional” and some Caribbean country lots.</p> <p>6–8 Some Caribbean country lots and some Peruvian lots.</p>

**Descriptor****Description****Intensity level / Reference notes**

<b>Floral</b>	<b>Total floral</b> is composed of the following: <ul style="list-style-type: none"> <li>• <b>Orange blossom:</b> orange blossom flavour.</li> <li>• <b>Flowers:</b> jasmine, honeysuckle, rose, lilac, lilies, etc.</li> </ul>	0–2	West African lots.
		3–5	Appropriately fermented “Nacional” and some Caribbean country lots.
		6–8	Some Caribbean country lots and some Peruvian lots.

<b>Woody</b>	<b>Total woody</b> is composed of the following sub-attributes: <ul style="list-style-type: none"> <li>• <b>Light wood:</b> freshly cut cacao wood, white pine wood, maple wood, ice-cream/popsicle wooden stick.</li> <li>• <b>Dark wood:</b> oak, walnut, teak, mahogany.</li> <li>• <b>Resin:</b> pitch of pine or other resinous wood.</li> </ul>	0–2	-
		3–5	Some “Nacional” and many West African lots.

<b>Spice</b>	<b>Total spice</b> is composed of the following sub-attributes: <ul style="list-style-type: none"> <li>• <b>Spices:</b> dried coconut, nutmeg, cinnamon, cloves, cacao mass, tonka, vanilla, black pepper.</li> <li>• <b>Tobacco:</b> dried tobacco leaves.</li> <li>• <b>Savoury/Umami:</b> sodium glutamate, umami.</li> </ul>	0–2	In most origins.
		3–5	In some West African, Central and South American and Caribbean country lots.

<b>Nutty</b>	<b>Total nutty</b> is composed of the following sub-attributes: <ul style="list-style-type: none"> <li>• <b>Nutty – nut flesh:</b> the edible kernel of a light roasted nut – hazelnut, macadamia, pecan, walnut, cashew, almond, brazil nut</li> <li>• <b>Nutty – nut skins:</b> the flavour of lightly roasted nut skins – hazelnut, macadamia, pecan, walnut, cashew, almond, brazil nut</li> </ul>	0–2	In most origins.
		3–5	Some Central and South American and Caribbean countries’ lots and ancient Criollos.

<b>Caramel / Panela</b>	Aromas reminiscent of caramel, brown sugar and panela (unrefined cane sugar)	0–2	In most origins
		3–5	Some Central and South American and Caribbean countries’ lots and ancient Criollos

<b>Sweetness (only for chocolate)</b>	Basic taste of white sugar solutions, typically perceived in foods like candies and desserts that contain sugar (or other sweeteners such as aspartame) and also naturally found in other foods like fruits.
---------------------------------------	--

Descriptor	Description	Intensity level / Reference notes
<b>Roast degree</b>	A measure of the extent of the roasting the beans. Significant under or over roasting alters many of the attribute values.	2–3: Low roast 4–6: Medium roast 7: High roast 8–10: Levels of burnt/over-roasted
<b>Off-flavours</b>	<p><b>Total Off-Flavours</b> is composed of any unpleasant characters from the following:</p> <ul style="list-style-type: none"> <li>• <b>Dirty/dusty:</b> not related to texture but to an off-flavour.</li> <li>• <b>Musty:</b> stale, damp, mildew, decaying.</li> <li>• <b>Mouldy:</b> characteristic of mould growth.</li> <li>• <b>Meaty/animal/leather:</b> <ul style="list-style-type: none"> <li>» Meaty – cured meat, ham, rendered fat.</li> <li>» Animal – dirty animal / farmyard.</li> <li>» Leather – used old leather.</li> </ul> </li> <li>• <b>Over-fermented/rotten fruit:</b> decomposing fruit.</li> <li>• <b>Putrid/manure:</b> <ul style="list-style-type: none"> <li>» Putrid – wet decomposing vegetative matter.</li> <li>» Manure – farmyard animal manure.</li> </ul> </li> <li>• <b>Smoky:</b> contamination from the smoke (any kind).</li> <li>• <b>Other off-flavours:</b> rancid, diesel, oil fumes, petroleum, tar, paint, tyres, chemicals, burnt, etc.</li> </ul>	0: Absent – clean, well fermented, dried and stored cacao beans. 1–2: Low intensity. 3+: Clearly characterizing the sample as a defect.
<b>Global Quality</b>	<p>The <b>Global Quality</b> score reflects the overall impression of the:</p> <ul style="list-style-type: none"> <li>• expressed flavour potential</li> <li>• uniqueness of the sample</li> <li>• balance of flavour and cleanliness of the finish</li> </ul> <p>It celebrates the expression of genetics and terroir diversity through the farmer's knowhow.</p>	Global Quality scores and meaning below



China-Zhong Chu - Hainan Xingke Tropical Crops Engineering Technology Co. LTD - P3

**Table 39.** Meaning of the global quality scores for the sensory evaluation of cacao beans processed into mass and chocolate (Cacao of Excellence 2023).

	Off-flavours	Core attributes	Complementary attributes	Notes
<b>0</b>	Serious off-flavours clearly characterizing the sample as defective	Masked by off-flavours	Masked by off-flavours	Be as specific as possible on the type of off-flavours as this is valuable feedback to the producers  Depending on the type, number and intensity of off-flavours, 0 would be the worst case and 3 the least but still bad
<b>1</b>				
<b>2</b>				
<b>3</b>				
<b>4</b>	In low intensity	Seriously unbalanced	Masked by off-flavours and unbalanced core attributes	
<b>5</b>	In low intensity	Unbalanced	Partially masked by unbalanced core attributes	
<b>6</b>	In low intensity or absent	Unbalanced	In low intensity, none outstanding, not in balance to core attributes	Overall plain flavour – mainly characterized by the core attributes and less by the complementary attributes
<b>7</b>	Absence of any	Balanced	One or more are outstanding but not in balance to core attributes	Overall plain flavour – mainly characterized by the core attributes and less by the complementary attributes
<b>8</b>	Absence of any	Well balanced with moderate base cacao flavour	One or more are outstanding, in balance to core attributes and to each other	Overall flavour presents some complexity
<b>9</b>	Absence of any	Well balanced, good base cacao flavour	Many outstanding, in balance to core attributes and to each other	Overall flavour presents a combination of complexity, uniqueness, harmony, brightness, clean finish
<b>10</b>	Absence of any	Well balanced, in low to moderate intensity, good base cacao flavour	Clearly recognizable, many outstanding, in balance to core attributes and to each other	Overall flavour presents a combination of complexity, uniqueness, harmony, brightness, clean finish  The sample is of extraordinary quality, rarely seen

### 20.3 Forms for the sensory evaluation of cacao beans

Sensory data resulting from the evaluation of each sample can be recorded in various formats. The tables and figures below contain examples of forms used for evaluating cacao beans in the forms of unroasted coarse powder, cacao mass, and dark chocolate. For a detailed evaluation, a total score for the sub-attributes can be calculated using the indicated formula (a declining series). This ensures that the total score accurately represents the overall intensity of the flavour attribute and is not simply the sum of all sub-attributes, with the exception for the Total Acidity score, which is calculated as the sum of the sub-attributes. Experts have advised that for this specific core attribute (acidity being a basic taste and non-volatile), scoring the total perception first and then describing each component separately yields a more accurate Total Score.

Sensory evaluation data can be recorded using a Microsoft® Excel® form such as the Cacao of Excellence Sensory Evaluation Form, which provides a user-friendly interface (Figure 21). Additionally, Cacao of Excellence offers a printed version of the evaluation form (Figure 22). The form can be simplified by using the main core attributes only as shown in Table 42.

**Table 40.** Sensory evaluation form for unroasted cacao beans as coarse powder (Adapted from FCCI).

### Sensory evaluation form for unroasted cacao beans as coarse powder

Jane Doe	dd/mm/yy	hh:mm – pm/am	000
Assessor name	Date of evaluation	Time of evaluation	Sample code

---

**SCORE (0-10) Core attributes**

\_\_\_\_\_ **Cacao**

\_\_\_\_\_ **Acidity** (fruity, acetic, lactic, mineral, butyric)

\_\_\_\_\_ **Bitterness**

\_\_\_\_\_ **Astringency**

**Complementary attributes**

\_\_\_\_\_ **Fresh fruit** (berry, citrus, dark, yellow/orange/white flesh, tropical)

\_\_\_\_\_ **Browned fruit** (dried, brown, over ripe)

\_\_\_\_\_ **Vegetal** (grassy/green herbal/herbal, earthy/mushroom, moss/woody)

\_\_\_\_\_ **Floral** (orange blossom, flowers)

\_\_\_\_\_ **Woody** (light or dark wood, resin)

\_\_\_\_\_ **Spice** (spices, tobacco (dried tobacco leaves), savoury/umami)

\_\_\_\_\_ **Nutty** (nut flesh and nut skins)

\_\_\_\_\_ **Caramel panela**

**Off-flavours**

\_\_\_\_\_ Mouldy

\_\_\_\_\_ Smoky

\_\_\_\_\_ Hammy

\_\_\_\_\_ Dirty/dusty

\_\_\_\_\_ Musty

\_\_\_\_\_ Cardboard

\_\_\_\_\_ Meaty

\_\_\_\_\_ Rancid

\_\_\_\_\_ Cheesy

\_\_\_\_\_ Manure/Animal excrement

\_\_\_\_\_ Leather

\_\_\_\_\_ Sweaty

\_\_\_\_\_ Putrid/wet decomposing vegetative matter

\_\_\_\_\_ Rotten/decomposing fruit

\_\_\_\_\_ Ammonia

\_\_\_\_\_ Petroleum

\_\_\_\_\_ Rubbery/sulphurous

\_\_\_\_\_ Metallic

\_\_\_\_\_ Phenolic

\_\_\_\_\_ Medicinal

\_\_\_\_\_ Chemical

\_\_\_\_\_ **Other off-flavours**

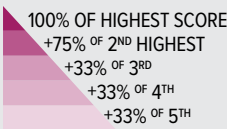
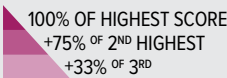


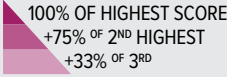
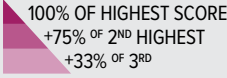

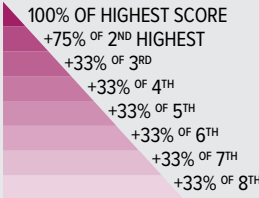
\_\_\_\_\_ **Other off-flavours description** \_\_\_\_\_

\_\_\_\_\_ **Global quality score**

**Comments** \_\_\_\_\_

**Table 41.** Calculations of the total scores for the flavour attributes of the Cacao of Excellence Sensory Evaluation Form.

### Calculations of the Total Scores for the Flavour Attributes

	<b>SCORE (0-10)</b>	<b>Core attributes</b>
	_____	<b>CACAO</b>
	_____	<b>ROAST DEGREE</b>
	_____	<b>BITTERNESS</b>
	_____	<b>ASTRINGENCY</b>
<b>TOTAL OF ALL SUB-ATTRIBUTES</b>	▶	<b>TOTAL ACIDITY</b>
	_____	Fruit
	_____	Acetic
	_____	Lactic
	_____	Mineral and Butyric
		<b>Complementary attributes</b>
<b>CALCULATED FIELD:</b>	▶	<b>TOTAL FRESH FRUIT</b>
	_____	Berry
	_____	Citrus
	_____	Dark
	_____	Yellow / Orange / White flesh
	_____	Tropical
<b>CALCULATED FIELD:</b>	▶	<b>TOTAL BROWNED FRUIT</b>
	_____	Dried
	_____	Brown
	_____	Over ripe
<b>CALCULATED FIELD:</b>	▶	<b>TOTAL VEGETAL</b>
	_____	Grassy/green vegetal/herbal
	_____	Earthy/mushroom – moss / woody
<b>CALCULATED FIELD:</b>	▶	<b>TOTAL FLORAL</b>
	_____	Orange blossom
	_____	Flowers
<b>CALCULATED FIELD:</b>	▶	<b>TOTAL WOODY</b>
	_____	Light wood
	_____	Dark wood
	_____	Resin
<b>CALCULATED FIELD:</b>	▶	<b>TOTAL SPICE</b>
	_____	Spices
	_____	Tobacco (dried tobacco leaves)
	_____	Savoury/umami
<b>CALCULATED FIELD:</b>	▶	<b>TOTAL NUTTY</b>
	_____	Nut flesh
	_____	Nut skins
	_____	
	_____	<b>CARAMEL / PANELA</b>
	_____	<b>SWEETNESS</b> (Only for chocolate)
<b>CALCULATED FIELD:</b>	▶	<b>Total off-flavours</b>
	_____	Dirty/dusty
	_____	Musty
	_____	Mouldy
	_____	Meaty/animal/leather
	_____	Over fermented/rotten fruit
	_____	Putrid/manure
	_____	Smoky
	_____	Other off-flavour description
IF THE RESULT IS >10 IT IS ROUNDED TO 10 AS THE MAXIMUM	_____	<b>GLOBAL QUALITY</b>
	_____	<b>Comments on flavour</b>

# Cacao of Excellence Sensory Evaluation Form for Cacao Mass and Chocolate

Evaluator:

Sample ID:

Sample info:

Start Evaluation

Recall/Edit

Date:

Time:

Intensity Scale

Less Intense 0 1 2 3 4 5 6 7 8 9 10 More Intense

Click 'Start Evaluation' to enable input to sensory evaluation attributes

Cacao	Bitterness	Astringency	Roast Degree
0	0	0	0
Acidity (Total)	Fruit	Acetic	Lactic
0.0	0	0	0
Fresh Fruit (Total)	Berry	Citrus	Dark
0.0	0	0	0
	Yellow / Orange / White flesh		Tropical
0.0	0	0	0
Browned Fruit (Total)	Dried	Brown	Over ripe
0.0	0	0	0
Vegetal (Total)	Grassy / Green vegetal / Herbal		Earthy / Mushroom / Moss / Woodsy
0.0	0	0	0
Floral (Total)	Orange blossom		Flowers
0.0	0	0	0
Woody (Total)	Light	Dark	Resin
0.0	0	0	0
Spice (Total)	Spices	Tobacco	Savory / Umami
0.0	0	0	0
Nutty (Total)	Nut flesh	Nut skins	
0	0	0	0
Caramel / Panela			
0.0	0	0	0
Off-flavours (Total)	Dirty / Dusty	Musty	Meaty / Animal / Leather
0.0	0	0	0
Calculated values	Over-fermented / Rotten fruit	Putrid / Manure	
0	0	0	0
	Smoky	Other	Description
0	0	0	0

Additional positive qualities

← Add selected quality (for Global Quality >= 7)

Global Quality

0 1 2 3 4 5 6 7 8 9 10

Overall Flavour comment

Feedback to producer

End Evaluation

Additional positive qualities

0 1 2 3 4 5 6 7 8 9 10

The Cacao of Excellence Sensory Evaluation Form is licensed under Creative Commons Attribution-NonCommercial 4.0 International (CC BY-NC 4.0). To see a copy of the license visit <https://creativecommons.org/licenses/by-nc/4.0/>

© Bioversity International 2023

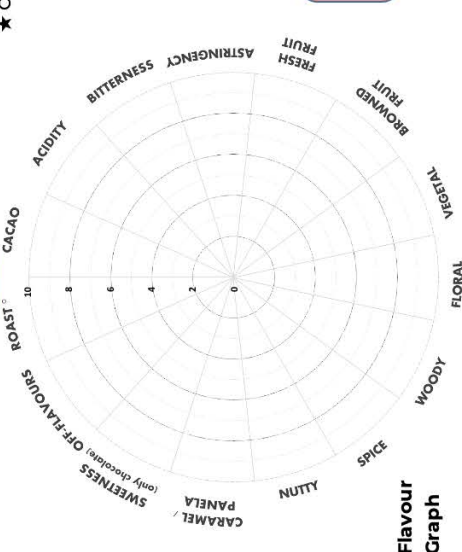
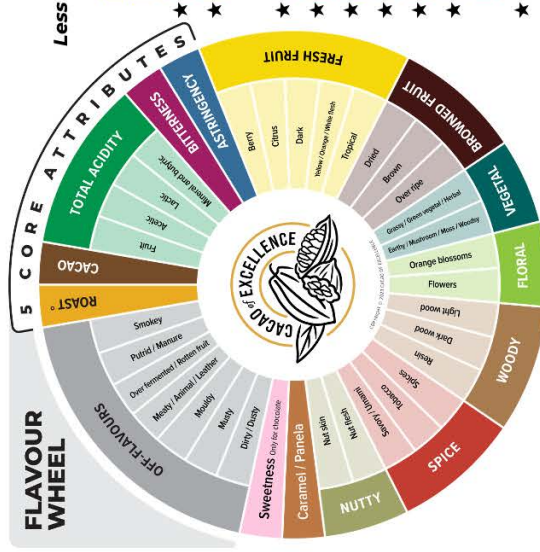


Figure 21. User interface of the Excel version of the Cacao of Excellence Sensory Evaluation Form with the total scores of flavour attributes calculated (Cacao of Excellence 2023).





**Table 42.** Simplified list of flavour attributes for sensory evaluation of cacao beans processed into mass and chocolate (Cacao of Excellence 2023).

**Cacao of Excellence - simplified list of flavour attributes for sensory evaluation of cacao beans processed into mass and chocolate 2023**

Jane Doe	dd/mm/yy	hh:mm – pm/am	000
Assessor name	Date of evaluation	Time of evaluation	Sample code

---

**Score (0-10) Attributes**

\_\_\_\_\_ **Cacao**

\_\_\_\_\_ **Acidity** (fruity, acetic, lactic, mineral, butyric)

\_\_\_\_\_ **Bitterness**

\_\_\_\_\_ **Astringency**

\_\_\_\_\_ **Fresh fruit** (berry, citrus, dark, yellow / orange/white flesh, tropical)

\_\_\_\_\_ **Browned fruit** (dried, brown, over ripe)

\_\_\_\_\_ **Vegetal** (earthy, mushroom, moss, woody, green vegetal, herbal)

\_\_\_\_\_ **Floral** (orange blossom, flowers)

\_\_\_\_\_ **Woody** (light or dark wood, resin)

\_\_\_\_\_ **Spice** (spices, tobacco (dried tobacco leaves), savoury/umami)

\_\_\_\_\_ **Nutty** (nut flesh and nut skins)

\_\_\_\_\_ **Sweetness (only for chocolate)**

\_\_\_\_\_ **Caramel / Panela**

\_\_\_\_\_ **Roast degree**

\_\_\_\_\_ **Off-flavours** (dirty/dusty, musty, mouldy, meaty / animal / leather, over fermented / rotten fruit, putrid / manure, smoky, other)

\_\_\_\_\_ **Off-flavours - others**

\_\_\_\_\_ **GLOBAL QUALITY**

**Comments on flavour** \_\_\_\_\_



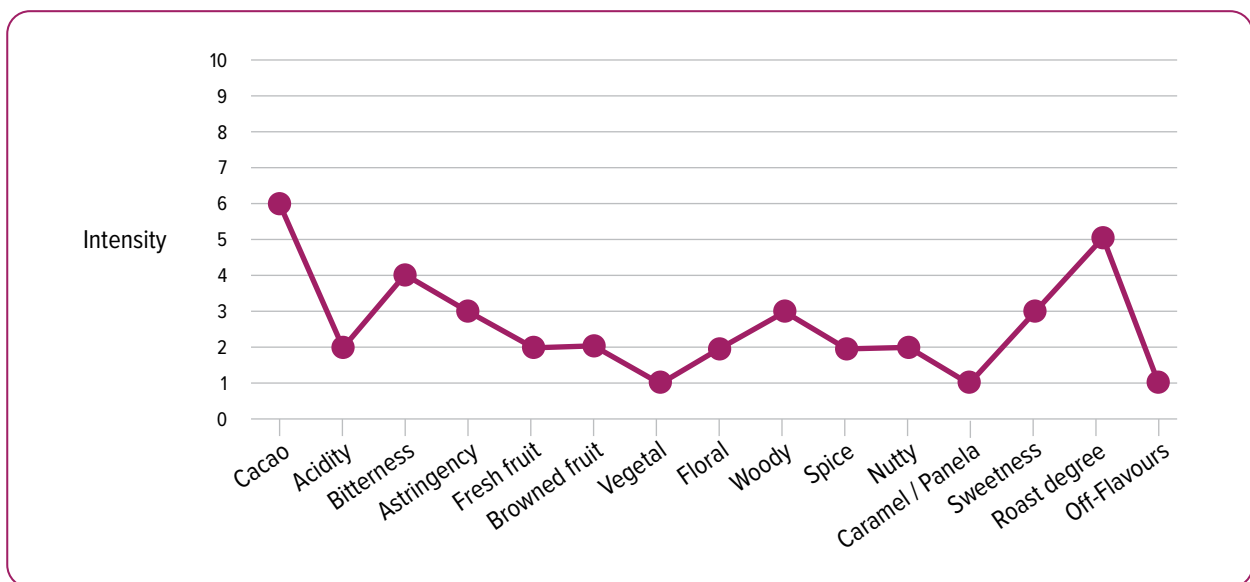
## 20.4 Sensory evaluation data analysis and panel performance

### 20.4.1 Visualisation of flavour profile data

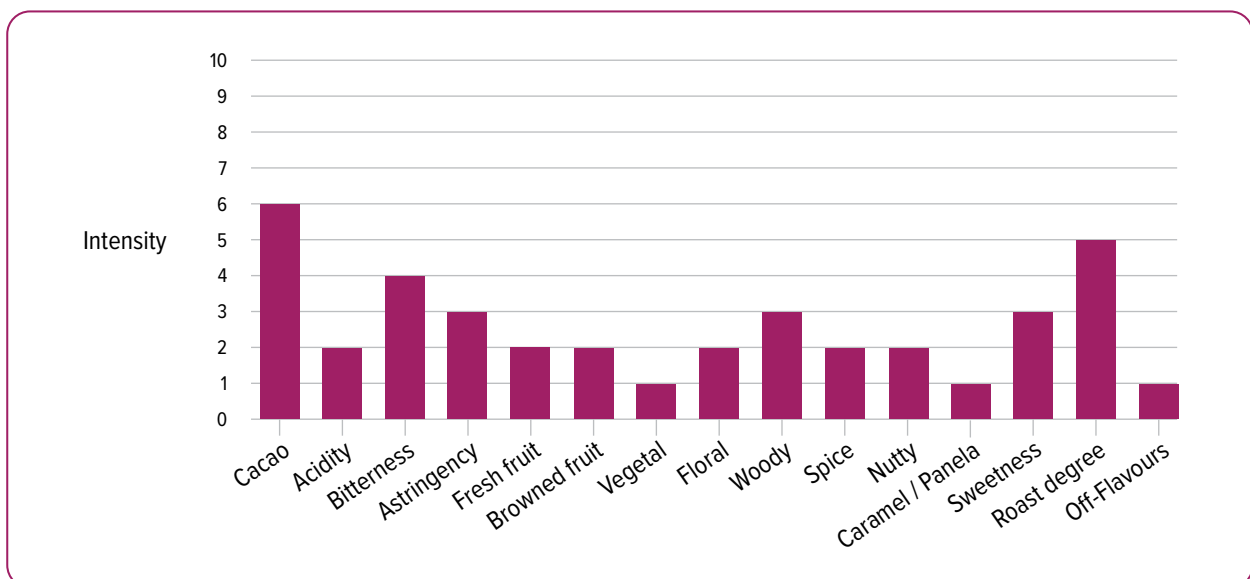
The result of the sensory evaluation can be expressed as a flavour profile for each cacao sample, showing the attributes and sub-attributes intensity, any off-flavours and a global quality score as well as comments. For conventional sensory flavour profiles, the results are obtained by the statistical analysis of data generated by several assessors (panel) evaluating the same samples and flavour attributes. Therefore, results of all individuals assessors in a panel is the mean and standard deviation of all the scores. And the means are used to build a flavour graph that can be visualised in different forms.

Some examples are:

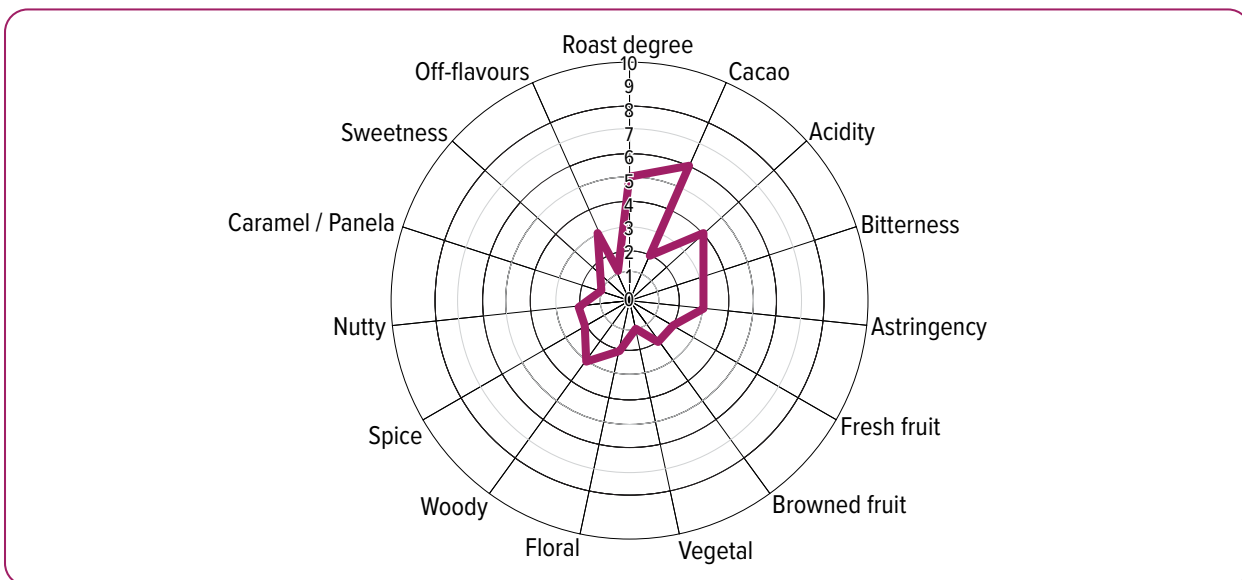
- Line graphs (Figure 23).
- Bar graphs (Figure 24).
- Radar plots or spider graphs (Figure 25).
- Cacao of Excellence flavour profile plots (Figure 26).



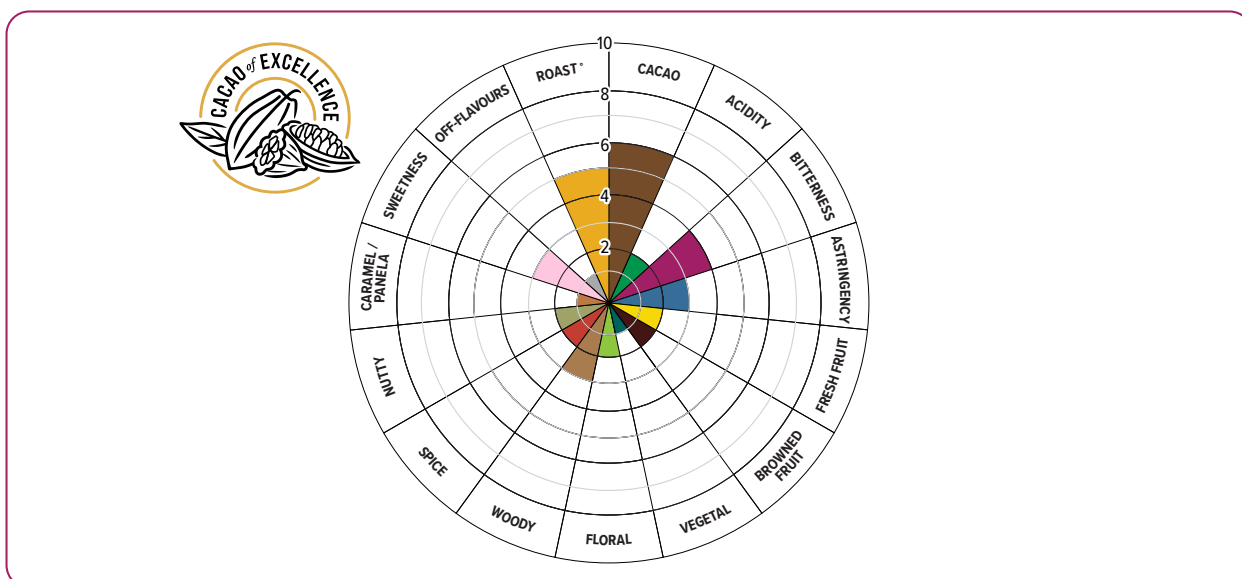
**Figure 23.** Example of a line graph for a cacao mass flavour profile (Bioversity International, 2018).



**Figure 24.** Example of a bar graph for a cacao mass flavour profile (Bioversity International, 2018).



**Figure 25.** Example of a spider/radar graph for a cacao mass flavour profile (Bioversity International, 2018).



**Figure 26.** Example of the Cacao of Excellence flavour profile plot.

### 20.4.2 Considerations on sensory profiling obtained by consensus

For sensory evaluation flavour profiles based on consensus (as defined by ISO 13299:2016), once the assessors have completed their individual evaluations, the panel leader or facilitator tabulates the results and moderates a discussion to address any differences in evaluation. If necessary, samples can be re-evaluated by the panel to reach a group consensus. A minimum of 4 assessors is required for this process. It's important to note that there is generally less reproducibility across panels and over time compared to quantitative flavour profiles that are obtained by calculating the mean and standard deviation of all panel members' scores (as described in Section 20.4.1).

### 20.4.3 Performance analysis of sensory evaluation panel members

To ensure the consistency and reliability of sensory evaluation panels, it is crucial to analyse and monitor their performance. This helps determine if they are aligned in their evaluations, possess the ability to discriminate between samples effectively, and exhibit repeatability when assessing the same sample blindly.

Performance analysis can be achieved through the evaluation of blind replicates and an adequate number of samples. Several software packages, such as Panel Check ([panelcheck.com](http://panelcheck.com)), are designed for this purpose, focusing on assessing panel performance in terms of discrimination, repeatability and alignment among assessors. Additionally, they provide sample flavour profiles (refer to Figure 23) and offer descriptive and exploratory statistical analyses.

This information is valuable for providing objective feedback to panel members and for monitoring improvements in specific flavour attributes, scale utilisation, and any other areas that may require further alignment.

#### 20.4.4 Documentation of sample processing and sensory evaluation conditions

An accurate and detailed description of the process of converting the cacao beans into cacao mass or chocolate and any additional information is essential in order to interpret the results of the sensory evaluation for comparison among samples and to communicate the results to cacao value chain stakeholders.

In addition to the flavour profiles of the evaluated samples, it is important to record the conditions in which the sensory evaluation was carried out as this affects the interpretation of the results. The robustness of the evaluation process can be assessed based on various factors, including the type of panel, the number of assessors, the use of replicates, and the inclusion of reference samples for calibration purposes.

Tables 43 and 44 presents an example of the information that should be recorded on the process of converting cacao bean samples evaluated into cacao mass or chocolate and the conditions of sensory evaluation.

By diligently documenting such information, organisations can enhance the reliability and traceability of their sensory evaluations, enabling them to make informed decisions based on the collected data.

**Table 43.** Information to be recorded for cacao sample processing.

<b>Cacao samples processing information</b>	
Date of the sample preparation	_____
Name of person that prepared the samples	_____
Location of the sample preparation	_____
Amount of beans processed per sample	_____
For cacao mass - physical state for evaluation (melted or solid)	_____
For chocolate - physical state for evaluation (melted or solid)	_____
Type, brand and model of roasting oven	_____
Temperature and time of roasting	_____
Type, brand and model of grinder used	_____
Number of samples evaluated	_____
Number of unknown samples evaluated	_____
Replicates (number times each cacao mass sample is evaluated)	_____
Use of reference samples for calibration (yes/no or number)	_____
Use of blind control samples (yes/no or number)	_____
Comments	_____

**Table 44.** Information to be recorded for a sensory evaluation.

**Sensory evaluation conditions**

Date of the sample evaluation \_\_\_\_\_

Panel or individual evaluation \_\_\_\_\_

If a panel – name of the leader/facilitator \_\_\_\_\_

If a panel – number of assessors in the panel \_\_\_\_\_

If an individual - name of the assessor \_\_\_\_\_

Location of panel member (all in the same place or virtual) \_\_\_\_\_

Training level of assessors (advanced, intermediate, beginner) \_\_\_\_\_


Type of sensory profile (quantitative or consensus) \_\_\_\_\_

Number of sessions to evaluate all unknown samples \_\_\_\_\_

Time interval between samples \_\_\_\_\_

Comments \_\_\_\_\_



 Belmont Estate Grenada





# Annexes

## Annex 1. Steps for a randomised selection of specific bags in a lot

**Step 1.** Number the bags in the lot



**Step 2.** Calculate the number of bags to sample

$$\text{Number of bags to sample} = 30\% \times 64 = 20$$

**Step 3.** Generate random numbers

20 random numbers in the range 1–64

50	12	7	62	44	26	36	3	24	61
32	53	46	14	16	5	39	58	18	33

**Step 4.** Sample the bags corresponding to the numbers



**Figure 27.** Steps for a randomised selection of specific bags in a lot.

## Annex 2. Quartering process diagrams

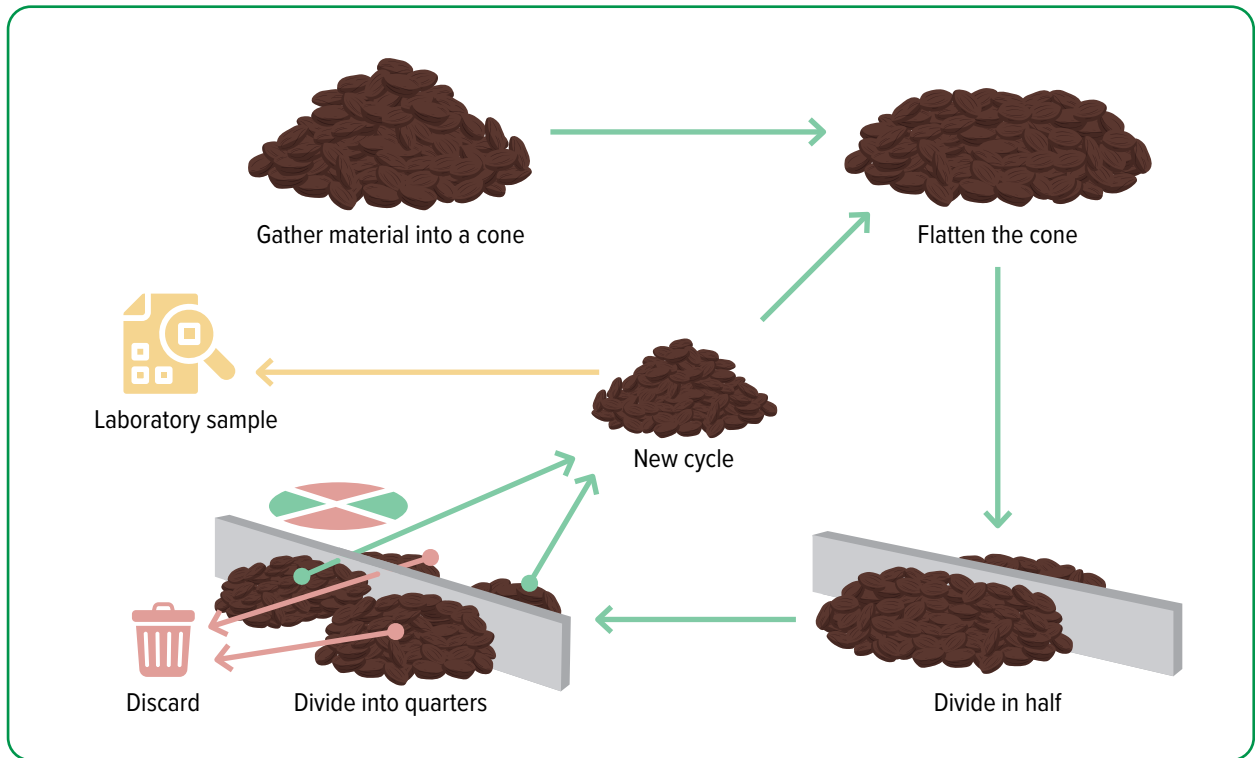


Figure 28. Diagram of quartering process (Harvey, 2013).

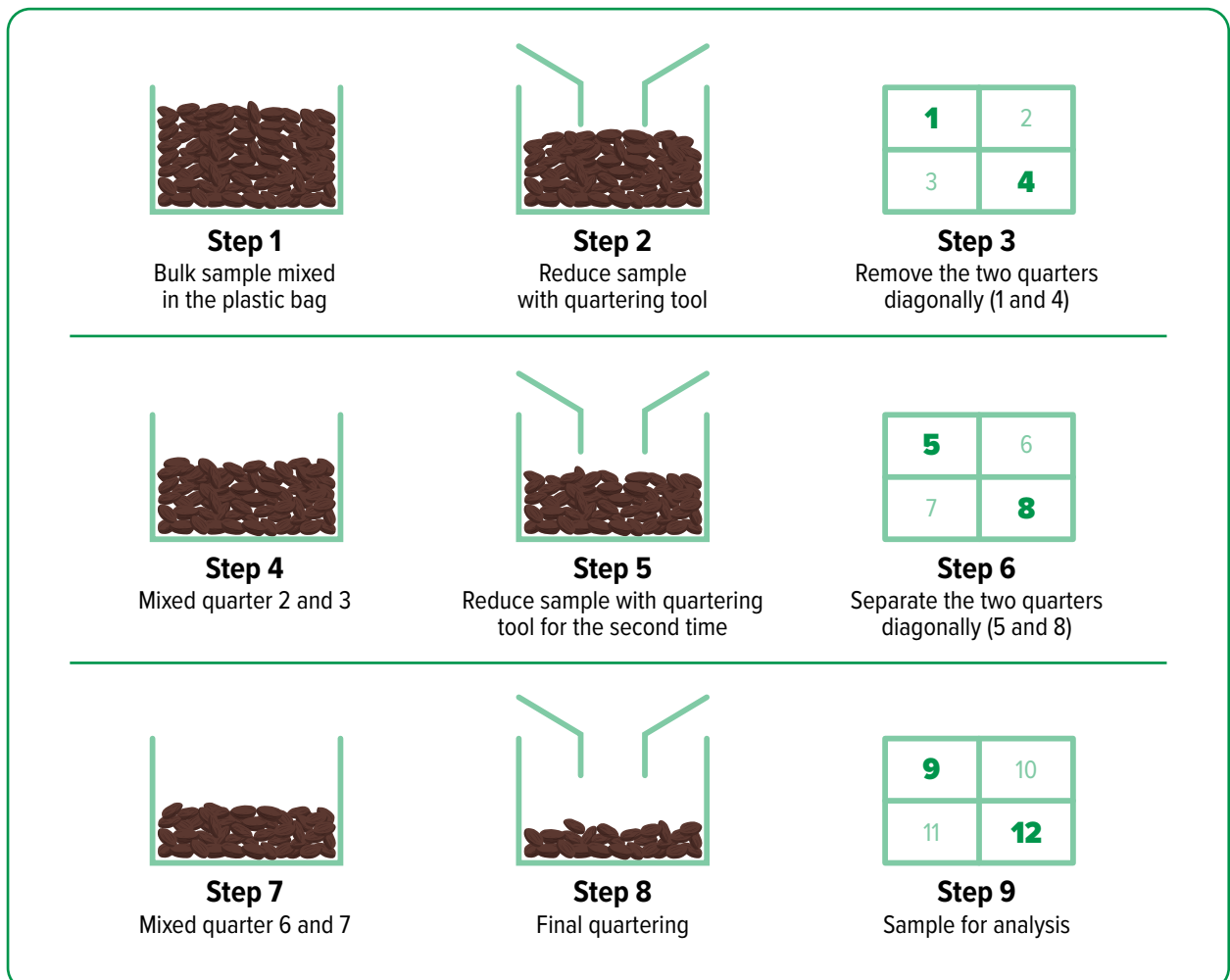


Figure 29. Preparation of reference samples using a quartering tool (MS, 230:2007).

## Annex 3. Example of calculation of moisture content for oven method

A laboratory analyst carrying out moisture content determination on a sample of fermented and dried cacao beans recorded the following data:

Mass (g)	Trial #1	Trial #2
Empty dish with lid ( $m_0$ )	21.1304	23.6706
Dish with lid + test sample before drying ( $m_1$ )	31.1364	33.6881
Dish with lid + test sample after drying ( $m_2$ )	30.4119	32.9558

To determine the moisture content, the following calculations are made using the formula:

$$\text{moisture content} = (m_1 - m_2) \times \frac{100}{m_1 - m_0}$$

### For Trial #1

$$\begin{aligned} \text{moisture content} &= (m_1 - m_2) \times \frac{100}{m_1 - m_0} \\ &= (31.1364 - 30.4119) \times \frac{100}{31.1364 - 21.1304} \\ &= 0.7245 \times 9.9940 \\ &= \mathbf{7.24\%} \end{aligned}$$

### For Trial #2

$$\begin{aligned} \text{moisture content} &= (m_1 - m_2) \times \frac{100}{m_1 - m_0} \\ &= (33.6881 - 32.9558) \times \frac{100}{33.6881 - 23.6706} \\ &= 0.7323 \times 9.9825 \\ &= \mathbf{7.31\%} \end{aligned}$$

The moisture content of this particular cacao sample is the mean or average of these two measurements:

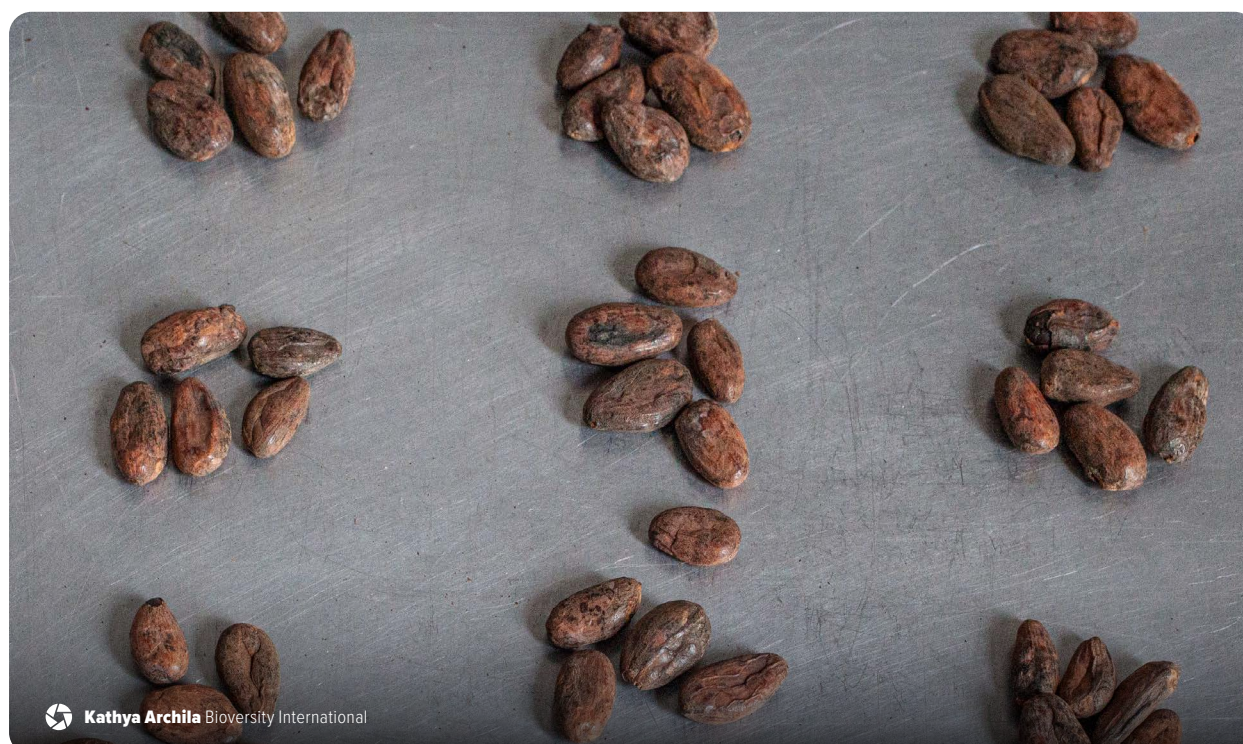
$$\begin{aligned} \text{moisture content} &= \frac{MC_{\text{TRIAL\#1}} + MC_{\text{TRIAL\#2}}}{2} \\ &= \frac{7.24\% + 7.31\%}{2} \\ &= \mathbf{7.28\%} \end{aligned}$$

**Therefore, the moisture content of the sample is 7.28**

Figure 30. Sample calculation of moisture content.

**Table 45.** Examples of moisture metres.

Brand	Models	Measuring method	Sample size	Measuring range	Accuracy	Web Page
<b>Aqua Boy</b>	• KAM I	Electrical conductivity	≈200g	N/A	±0.1%	<a href="http://aqua-boy.co.uk">aqua-boy.co.uk</a>
	• KAM II			2–20%	±0.1%	
	• KAM IIIa			10–34%	±0.1%	
<b>Dickey-John</b>	• mini GAC® 2500	149MHz – UGMA technology, internal scale, temperature, i.e. measurement of dielectric constant at frequency near 149MHz	≈450g	5–45%	±0.1%	<a href="http://dickey-john.com">dickey-john.com</a>
<b>Wile</b>	• Wile 200 Coffee	Capacitive moisture sensing	≤500g	3–18%	±0.6%	<a href="http://wile.fi/en">wile.fi/en</a>
	• Wile Coffee & Cocoa		≈70g	4–20%	±0.5%	
<b>AgraTronix</b>	• Portable Coffee Moisture Tester 08150	Capacitive moisture sensing	≤80g	4–20%	±0.5%	<a href="http://agratronix.com">agratronix.com</a>
<b>Schaller Messtechnik</b>	• Humimeter FS3	• Equilibrium humidity measurement	≈300g	0–40%	±0.4%	<a href="http://humimeter.com/en">humimeter.com/en</a>
	• Humimeter FS4	• Infrared	≈450g	0–50%	N/A	



## Annex 4. Calculation of the standard deviation of the bean count

If needed, the standard deviation of the bean count can be calculated. This is an assessment of bean size homogeneity of a given lot of cacao beans. The standard deviation calculation considers the average number of beans per 100g for the entire lot and compares this against the overall variability of bean sizes within the same lot. Standard deviations below  $\leq 25$  are expected. High standard deviation values ( $>25$ ) are indicative of a heterogeneous bean lot.

In order to obtain the standard deviation of the bean count.

- Number of beans per sieve and base (A, B, C, or D below):

$$(A, B, C, \text{ or } D) = \frac{\text{number of beans in sieve}}{\text{weight of beans in sieve}} \times 100$$

- Weight of beans per sieve and base (P, Q, R, or S below):

$$(P, Q, R, \text{ or } S) = \frac{\text{weight of beans in sieve}}{\text{total weight of beans}}$$

- Total bean count per 100g (Z below):

$$Z = \frac{\text{Total number of beans in each sieve and base}}{\text{Total weight of beans in each sieve and base}} \times 100$$

Use the following formula to compute the standard deviation of the bean count test:

$$SD = \sqrt{(P(Z - A))^2 + Q(Z - B)^2 + R(Z - C)^2 + S(Z - D)^2}$$

Where:

**A** = bean count/100g in 13mm round-holed sieve

**B** = bean count/100g in 11.5mm round-holed sieve

**C** = bean count/100g in 10.5mm round-holed sieve

**D** = bean count/100g in base

**P** = % bean-weight to total weight in 13mm round-holed sieve

**Q** = % bean-weight to total weight in 11.5mm round-holed sieve

**R** = % bean-weight to total weight in 10.5mm round-holed sieve

**S** = % bean-weight to total weight in base

**Z** = total bean count/100g

An example of a grading system that includes the standard deviation of the bean count is shown in Table 46.

A sample of 600g of clean and sorted cacao beans was taken from the initial 2kg reference sample and passed through three sieves of different mesh sizes to determine the standard deviation of the bean count, and indicator of homogeneity of size in the lot, as shown in the Table 46 below.

**Table 46.** Example of variables for the calculation of the standard deviation.

Sieve	Variable	Unit	Value
13mm	Beans	Mass (g)	240g
	P	Number of beans	192
	A	%	40%
		Bean count	80 beans/100g
11.5mm	Beans	Mass (g)	280g
	Q	Number of beans	280
	B	%	47%
		Bean count	100 beans/100g
10.5mm	Beans	Mass (g)	60g
	R	Number of beans	72
	C	%	10%
		Bean count	120 beans/100g
Base	Beans	Mass (g)	20g
	S	Number of beans	30
	D	%	3%
		Bean count	150 beans/100g
Total	Beans	Mass (g)	600g
		Number of beans	574
	Z	Bean count	96 beans/100g
	Standard deviation	Bean count	16 beans/100g



## Annex 5. Examples of defective whole beans



**a) Foreign matter**



**b) Placenta**



**c) Flat beans**



**d) Clusters**



**e) Broken beans**



**f) Shells and bean fragments**



**g) Infested beans**

**Figure 31.** Categories of cleaning loss in cacao beans: a) foreign matter b) placenta; c) flat beans; d) bean clusters; e) broken or cut beans; f) shell and bean fragments; and g) infested beans (Bioversity International, Archila, 2022).

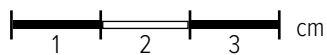
Annex 6. **Cut bean reference pictures**



**Figure 32.** Typical colour of cacao beans with increasing degree of fermentation (from left to right) (Bioversity International, Archila, 2022).



## Cacao Cut Test Chart




**Figure 33.** Examples of cut cacao beans at different stages of fermentation (Sukha and Rohsius, 2004).

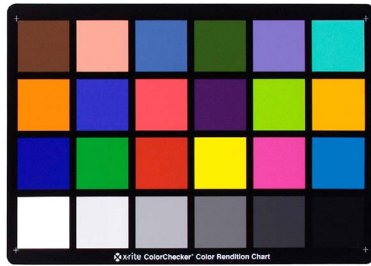


**Figure 34.** Increasing degree of cacao bean fissuring from top left to bottom right (Bioversity International, Archila, 2022).



 Dolores Alvarado Bioversity International

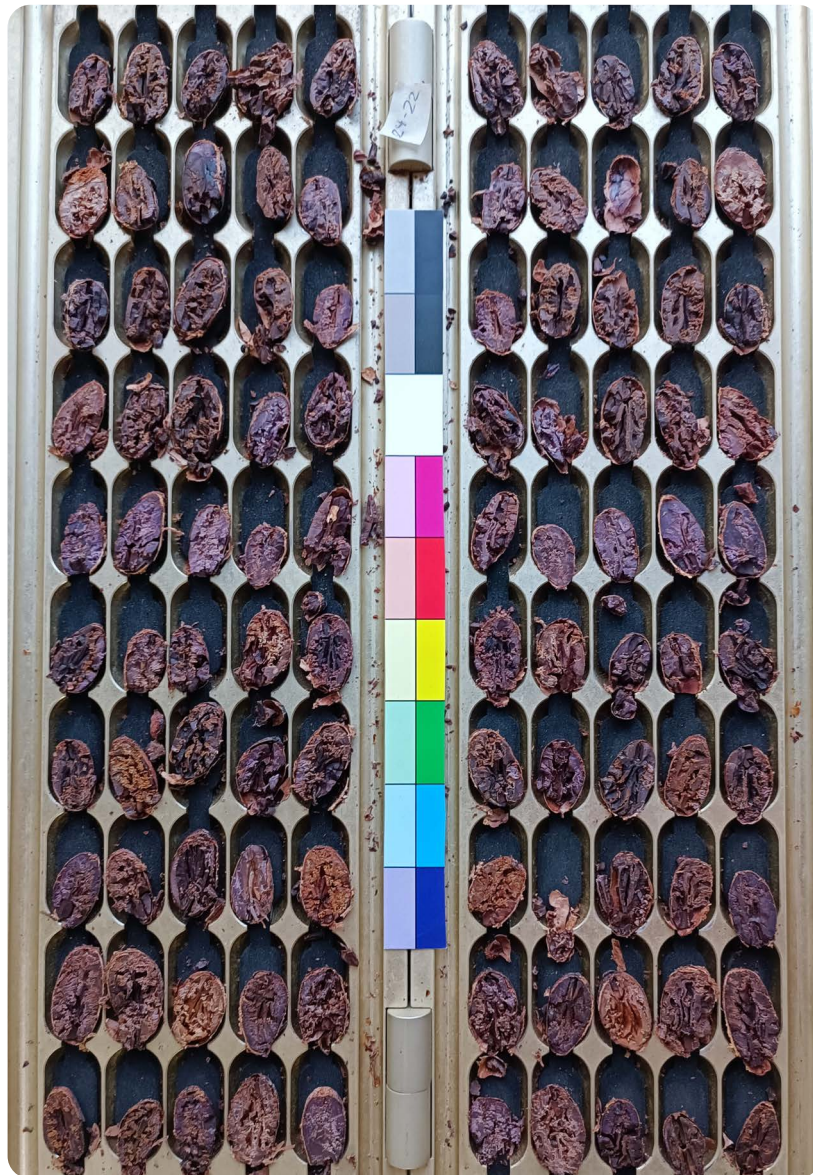
## Annex 7. Examples of colour guides for picture taking



a)



b)



c)

**Figure 35.** Colour reference tool for photographs of beans. a) MacBeth ColorChecker (Kreslin et al, 2014); b) Tiffen Color Control Patches similar exist from other brands like Kodak, Fuji Film and others; and c) use of adapted colour reference tool for cut test picture (Bioversity International, Alvarado, 2018 ).

## Annex 8. Cacao bean standards by country and organisation

**Table 47.** Comparison of bean grade according to existing standards (Beckett, 2009, End and Dand, 2015, US FDA, 2017).

Standards	Bean grade/ description	Bean count	CATEGORIES OF DEFECTS				Moisture %	Foreign matter
			Mould %	Slaty %	Insect- infested %			
<b>ISO 2451:2017</b>	Grade I	NS <sup>a, b</sup>	3	3	3	≤7.50 <sup>b</sup>	0.75% <sup>b</sup>	
	Grade II		4	8	6			
<b>FCC<sup>c</sup></b>	Good fermented	100 per	5 <sup>d</sup>	5	5 <sup>d</sup>	NS <sup>b</sup>	<1.50% <sup>b, e</sup>	
	Fair fermented	100g <sup>b</sup>	10 <sup>d</sup>	10	10 <sup>d</sup>			
<b>CMAA<sup>f</sup></b>	Ghana	1,000 per kg	4 <sup>g</sup>	10	4 <sup>g</sup>	NS	NS	
<b>FDA</b>	Acceptable	NS	4	-	4	NS	≥10.00 mg/lb <sup>h</sup>	
<b>ASEAN Stan 34:2014</b>	Extra Class	NS <sup>b</sup>	3	3	2.5	<7.50 <sup>b</sup>	Practically free of waste	
	Class 1		3	5	3		<2.00%	
	Class 2		4	8	5		<2.50%	
<b>The Conseil Café Cacao, Côte d'Ivoire</b>	Grade I	105 per	3	3	3 <sup>i</sup>	≤8.00 <sup>b</sup>	≤1.00 <sup>b</sup>	
	Grade II	100g	4	8	6 <sup>i</sup>			
	Sub-grade		>4	>8	>6 <sup>i</sup>			
<b>Key</b>								
a NS - Not Specified.								
b Values are not distinct between grades.								
c Federation of Cocoa Commerce (FCC) specifies that the beans shall be uniform in size, homogeneous and fit for the production of foodstuffs. The beans must be virtually free from contamination, which includes smoky, hammy, or other off-flavour, taste, or smell.								
d Maximum values for defectives (mouldy + infested).								
e Value representing waste passing through 5mm sieve. Additionally, flat beans, bean clusters, and foreign matter must not be excessive.								
f Cocoa Merchants' Association of America (CMAA) specifies that hammy or smoky beans are not deliverable.								
g Maximum amount of mould + infestation is 6% (US FDA Defect Action Levels).								
h Criteria for recommending legal action.								
i Maximum bean counts for primary and intermediate grades are 105 and 120, respectively.								
j Other defects including insect infested.								

**Table 48.** Cacao bean grading standards by country (Dand and Scheu, 1995 published in UNCTAD and WTO, 2001).

Country	Standard authority	Description	Faults (by percentage)							% Foreign matter	Other specifications and comments		
			Bean Count per 100g	Mould	Slaty	Infested	Germinated	Flat	Violet			Moisture	
	AFCC, from 1/1/99	Good fermented	100 (h)	5	5	(d)	NS	(i)	NS	(j)	1.5	Rejection possible if bean count above 120	
		Fair fermented	100 (h)	10	10	(d)	NS	(i)	NS	(j)	1.5	-	
	CAL, to be ratified	Good fermented	100 (h)	5	5	(d)	NS	(k)	NS	(l)	1.5	-	
		Fair fermented	100 (h)	10	10	(d)	NS	(k)	NS	(l)	1.5	-	
<b>(a)</b>	FAO Model Ordinance	Grade I (b)	(b)	3	3	3	(c)	(c)	(c)	NS	7.5	To be of merchantable quality, all cacao must be free of foreign odours, and must not be adulterated	
		Grade II (b)	(b)	4	8	6	(c)	(c)	(c)	NS	7.5	0	
<b>Brazil</b>	National Foreign Trade Council	Superior	NS	4	2	(d)	2	(e)	NS	8.0	SN	Max of each individual defect 2%, sum not to exceed 4%	
		Good fair	NS	6	4	(d)	4	(e)	NS	8.0	NS	Max of each individual defect 4%, sum not to exceed 6%	
		Sub-grade	NS	8	8	5	10	(e)	NS	8.0	1	Slight smoke odour admissible	
<b>Cameroon</b>	Office National du Cacao et du Café	Grade I (b)	(b)	3	3	3	(c)	(c)	(c)	NS	7.5	FAO Standards. To be of merchantable quality all cacao must be free of foreign odours, and must not be adulterated	
		Grade II (b)	(b)	4	8	6	(c)	(c)	(c)	NS	7.5	As for Grade I	
		Sub-standard (SS) cacao which exceeds grade II limits		-	-	-	-	-	-	-	-	-	Can only be marketed under special contract
<b>Congo</b>	Office de Commercialisation du Café et du Cacao	Supérieure	NS	3	3	3	3	3	NS	NS	NS	Max. of 3% of infested, germinated or flat	
		Courante	NS	4	8	6	6	6	NS	NS	NS	Max. of 6% of infested, germinated or flat	
		Limite	NS	NS	20	12	12	12	NS	NS	NS	Bags of "supérieure" marked with 1 disk, "courante" with 2, and "limite" with 3	
<b>Côte d'Ivoire</b>	Ministry of Agriculture	Grade I	Uniform	3	3	3	(c)	(c)	(c)	(c)	8.0	0	Lots must be of uniform colour and flavour, free of musty or smoky flavour, max 10% in excess of or below average of 1/3 of the average weight of the beans (grade 1 only)
		Grade II	NS	4	8	6	(c)	(c)	(c)	(c)	8.0	0	-
		Sous-grade	NS	NS	NS	NS	NS	NS	NS	NS	NS	NS	Any cacao which does not meet grade 2 specs. Export prohibited

Country	Standard authority	Description	Bean Count per 100g	Faults (by percentage)							% Foreign matter	Other specifications and comments	
				Mould	Staty	Infested	Germinated	Flat	Violet	Moisture			
<b>Dominican Republic</b>	Cocoa Department, Ministry of Agriculture	Sánchez	159	4	NS	3	3	3	(e)	NS	9.5	1	Smoky beans not permitted, max defect count on exportable cacao 6%
		Hispaniola, Grade I	120	3	1	3	3	3	(e)	10	7.5	0	Cacao which does not meet grading standards must be marked 'stocklot' on the bags and documents, and may be sold on special contract against sample only
		Hispaniola, Grade II	130	3	3	3	3	3	(e)	15	7.5	0	-
<b>Ecuador</b>	Ministry of Industry, Commerce, etc.	ASSPS	71-74	0	5	0	0	0	0	10	NS	0	Arriba Superior Summer Plantation Selected
		ASSS	75-77	1	9	(d)	(d)	(d)	(d)	15	NS	0	Arriba Superior Summer Selected
		ASS	81-83	3	12	(d)	(d)	(d)	(d)	20	NS	0	Arriba Superior Selected
		ASNS	81-83	2	13	(d)	(d)	(d)	(d)	25	NS	0	Arriba Superior Navidad Selected
		ASW	80-91	5	18	(d)	(d)	(d)	(d)	25	NS	0	Arriba Superior W
		ASES	80-83	2	18	(d)	(d)	(d)	(d)	30	NS	0	Arriba Superior Epoca Selected
ASE	91-95	6	30	(d)	(d)	(d)	(d)	25	NS	0	Arriba Superior Epoca		
<b>Gabon</b>		Natural	80-83	4	19	(d)	(d)	(d)	(d)	30	NS	0	May include 1% flat, 1% monilia ( <i>Monilia fructigena</i> ) damaged, 1% insect damaged and 1% black beans.
		Supérieure	NS	3	3	3	3	3	3	NS	NS	NS	Max of 3% of infested, germinated or flat
		Courant	NS	4	8	6	6	6	6	NS	NS	NS	Max. of 6% of infested, germinated or flat
		Limite	NS	NS	20	12	12	12	12	NS	NS	NS	-
<b>Ghana</b>	Ministry of Agriculture	Grade I	NS	3	3	3	(c)	(c)	(c)	NS	7.5	0	-
		Grade II	NS	4	8	6	(c)	(c)	(c)	NS	7.5	0	-
<b>Indonesia</b>	Indonesia Cocoa Association	Grade AA I	≤85	3	3	3	(c)	(c)	(c)	NS	7.5	0	To be of merchantable quality, all cacao must be free of foreign odours, and must not be adulterated
		Grade AA II	≤85	4	8	6	(c)	(c)	(c)	NS	7.5	0	-
		Grade A I	≤100	3	3	3	(c)	(c)	(c)	NS	7.5	0	-
		Grade A II	≤100	4	8	6	(c)	(c)	(c)	NS	7.5	0	Live insects - none.
		Grade B I	101-110	3	3	3	(c)	(c)	(c)	NS	7.5	0	-
		Grade B II	101-110	4	8	6	(c)	(c)	(c)	NS	7.5	0	Broken beans, nib or shell <3%.
		Grade C I	111-120	3	3	3	(c)	(c)	(c)	NS	7.5	0	-
		Grade C II	111-120	4	8	6	(c)	(c)	(c)	NS	7.5	0	F in the description denotes fine flavour.
Sub-grade												Cacao which exceeds Grade II limits	

Country	Standard authority	Description	Bean Count per 100g							Faults (by percentage)				% Foreign matter	Other specifications and comments	
			Mould	Slaty	Infested	Germinated	Flat	Violet	Moisture	Mould	Starchy	Infested	Germinated			Flat
<b>Malaysia</b>	Federal Agricultural Marketing Authority	SMC 1-A	<100	3	3	2.5	(c)	NS	NS	7.5	0	Cacao showing live infestation (more than 10 insects per bag requires fumigation).				
		SMC 1-B	100–110	3	3	2.5	(c)	NS	NS	7.5	0	SMC stands for Standard Malaysia Cacao				
		SMC 1-C	110–120	3	3	2.5	(c)	NS	NS	7.5	0					
		SMC 2-A	<100	4	8	2.5	(c)	NS	NS	7.5	0					
		SMC 2-B	100–110	4	8	2.5	(c)	NS	NS	7.5	0					
		SMC 2-C	110–120	4	8	2.5	(c)	NS	NS	7.5	0					
		Sub-standard	>120	>4	>8	>5	-	(c)	NS	NS	NS	0				
<b>Nigeria</b>	Federal Produce Inspection Service	Grade I	(b)	3	3	3	(c)	(c)	NS	7.5	0	To be of merchantable quality, all cacao must be free of foreign odours and must not be adulterated				
		Grade II	(b)	4	8	6	(c)	(c)	NS	7.5	0					
		Sub-standard										Cacao which exceeds Grade II limits				
<b>Papua New Guinea</b>	Cocoa Board	Export quality	(d)	5	1	(d)	(f)	(f)	NS	5.5–7.5	1	Board-approved fermentation/drying process free from foreign odours				
<b>Sierra Leone</b>	Sierra Leone Produce Marketing Board	Grade I	<96	3	3	3	3	3	NS	NS	NS	Max. 15% mould, slaty, infested, germinated or flat				
		Grade II	<96	4	8	6	6	6	NS	NS	NS	Max. 30% mould, slaty, infested, germinated or flat				
		Sub-grade										Cacao which exceeds Grade II limits				
<b>Solomon Islands</b>	Commodities Export Marketing Authority	Grade I	NS	3	3	3	(c)	(c)	NS	NS	0	Cacao for export must be fermented, thoroughly dry, free from abnormal or foreign odours and free from adulteration, reasonably free from live insects, broken beans, fragments and pieces of shell				
		Grade II	NS	4	8	6	(c)	(c)	NS	NS	0					
<b>Togo</b>		Grade I	(b)	3	3	3	(c)	(c)	NS	7.5	0	To be of merchantable quality, all cacao must be free of foreign odours, and must not be adulterated				
		Grade II	(b)	4	8	6	(c)	(c)	NS	7.5	0	Can only be marketed under special contract				
		Sub-standard										Cacao which exceeds Grade II limits				

Faults (by percentage)

Country Standard authority Description Bean Count per 100g Mould Slaty Infested Germinated Flat Violet Moisture % Foreign matter Other specifications and comments

Vanuatu	Department of Agriculture	I-A	<100	3	3	3	(c)	(c)	NS	7.0	NS	-
		I-B	101-120	3	3	3	(c)	(c)	NS	7.0	NS	-
		II	<120	4	<8	<6	(c)	(c)	NS	7.0	NS	-
		Sub-standard	<120	5-10	8	6-20	(c)	(c)	NS	7.0	NS	-
		Inferior	>200	>10	>50	>20	(c)	(c)	NS	7.0	NS	-

**United States of America** Food and Drug Administration FDA Defect Levels Handbook NS 4 NS 4 NS NS NS 0 Cacao must be sound, reasonably free of foreign matter or odour, free of live infestation and adulteration. Total defect count may not exceed 6%

**Western Samoa** 1989 Cocoa Act Export Standard <100 5 5 (c) 5 (e) NS 5.5-7.5 1 Slaty, flat, broken, fragments, germinated or defective beans should not exceed 5%. Free from foul and foreign odours

**Democratic Republic of the Congo** Bonne qualité <80 5 5 5 NS NS NS Max 10% of mould and infested  
Courante 81-85 5 5 5 NS NS NS Max 10% of mould and infested

**Key**

NS Not Specified.

a This ordinance has been adopted by several countries, in some cases with modification, but it has not force of law *per se*.

b Not more than 12% of the beans should be outside the range of +/- one-third of the average weight.

c Included in insect infested.

d Included in mould.

e Included in germinated.

f Included in foreign matter.

g Detailed schedule of discounts according to bean size.

h If description includes 'Main crop'.

i Flat beans shall be considered as defective beans only if the parcel is not subject to an allowance or replacement for bean count.

j Parcel must be dry.

k Considered as cacao shell.

## Annex 9. Adjustments in roasting time and temperature by cacao bean size and moisture content

**Table 49.** Adjustments in roasting temperature (°C) and time (minutes) by moisture content (%) and cacao bean size (bean count of 100g or average bean weight) (Cacao of Excellence Technical Committee, 2019).

For moisture content between 5.5 and 7.3%\*

Temperature (°C)	BEAN MOISTURE CONTENT (%)																						
	Time (min)	5.5	5.6	5.7	5.8	5.9	6.0	6.1	6.2	6.3	6.4	6.5	6.6	6.7	6.8	6.9	7.0	7.1		7.2	7.3		
BEAN COUNT PER 100 g	50	-4 0	-4 +1	-4 +1	-4 +1	-4 +2	-4 +2	-4 +2	-4 +3	-4 +3	-4 +3	-4 +4	-4 +4	-4 +4	-4 +5	-4 +5	-4 +5	-4 +6	-4 +6	-4 +6	2.00		
	55	-4 -1	-4 0	-4 0	-4 0	-4 +1	-4 +1	-4 +1	-4 +2	-4 +2	-4 +2	-4 +3	-4 +3	-4 +3	-4 +4	-4 +4	-4 +4	-4 +5	-4 +5	-4 +5	1.82		
	60	-3 -1	-3 -1	-3 -1	-3 0	-3 0	-3 0	-3 +1	-3 +1	-3 +1	-3 +2	-3 +2	-3 +2	-3 +2	-3 +3	-3 +3	-3 +3	-3 +4	-3 +4	-3 +4	-3 +5	1.67	
	65	-3 -2	-3 -2	-3 -1	-3 -1	-3 -1	-3 0	-3 0	-3 0	-3 +1	-3 +1	-3 +1	-3 +2	-3 +2	-3 +2	-3 +3	-3 +3	-3 +3	-3 +3	-3 +4	-3 +4	-3 +4	1.54
	70	-2 -3	-2 -2	-2 -2	-2 -2	-2 -1	-2 -1	-2 -1	-2 0	-2 0	-2 0	-2 +1	-2 +1	-2 +1	-2 +1	-2 +2	-2 +2	-2 +2	-2 +3	-2 +3	-2 +3	-2 +3	1.43
	75	-2 -3	-2 -3	-2 -3	-2 -2	-2 -2	-2 -2	-2 -1	-2 -1	-2 -1	-2 0	-2 0	-2 0	-2 +1	-2 +1	-2 +1	-2 +1	-2 +2	-2 +2	-2 +2	-2 +3	-2 +3	1.33
	80	-2 -4	-2 -4	-2 -3	-2 -3	-2 -3	-2 -2	-2 -2	-2 -2	-2 -1	-2 -1	-2 -1	-2 0	-2 0	-2 0	-2 0	-2 +1	-2 +1	-2 +1	-2 +2	-2 +2	-2 +2	1.25
	85	-1 -5	-1 -4	-1 -4	-1 -4	-1 -3	-1 -3	-1 -3	-1 -2	-1 -2	-1 -2	-1 -1	-1 -1	-1 -1	-1 -1	-1 0	-1 0	-1 0	-1 +1	-1 +1	-1 +1	-1 +1	1.18
	90	-1 -6	-1 -5	-1 -5	-1 -5	-1 -4	-1 -4	-1 -4	-1 -3	-1 -3	-1 -3	-1 -2	-1 -2	-1 -2	-1 -2	-1 -1	-1 -1	-1 -1	-1 0	-1 0	-1 0	-1 0	1.11
	95	0 -6	0 -6	0 -6	0 -5	0 -5	0 -5	0 -4	0 -4	0 -4	0 -3	0 -3	0 -3	0 -2	0 -2	0 -2	0 -2	0 -1	0 -1	0 -1	0 0	0 0	1.05
	100	0 -7	0 -7	0 -6	0 -6	0 -6	0 -5	0 -5	0 -5	0 -4	0 -4	0 -4	0 -3	0 -3	0 -3	0 -2	0 -2	0 -2	0 -2	0 -1	0 -1	0 -1	1.00
	105	0 -8	0 -7	0 -7	0 -7	0 -6	0 -6	0 -6	0 -5	0 -5	0 -5	0 -4	0 -4	0 -4	0 -3	0 -3	0 -3	0 -2	0 -2	0 -2	0 -1	0 -1	0.95
	110	0 -8	0 -8	0 -8	0 -7	0 -7	0 -7	0 -6	0 -6	0 -6	0 -5	0 -5	0 -5	0 -4	0 -4	0 -4	0 -3	0 -3	0 -3	0 -2	0 -2	0 -2	0.91
	115	0 -9	0 -9	0 -8	0 -8	0 -8	0 -7	0 -7	0 -7	0 -6	0 -6	0 -6	0 -5	0 -5	0 -5	0 -4	0 -4	0 -4	0 -3	0 -3	0 -3	0 -2	0.87
	120	0 -10	0 -9	0 -9	0 -9	0 -8	0 -8	0 -8	0 -7	0 -7	0 -7	0 -6	0 -6	0 -6	0 -5	0 -5	0 -5	0 -4	0 -4	0 -4	0 -3	0 -3	0.83
	125	0 -11	0 -10	0 -10	0 -10	0 -9	0 -9	0 -9	0 -8	0 -8	0 -8	0 -7	0 -7	0 -7	0 -6	0 -6	0 -6	0 -5	0 -5	0 -5	0 -4	0 -4	0.80
	130	0 -11	0 -11	0 -11	0 -10	0 -10	0 -10	0 -9	0 -9	0 -9	0 -8	0 -8	0 -8	0 -7	0 -7	0 -7	0 -6	0 -6	0 -6	0 -5	0 -5	0 -5	0.77
	135	0 -12	0 -12	0 -11	0 -11	0 -11	0 -10	0 -10	0 -10	0 -9	0 -9	0 -9	0 -8	0 -8	0 -8	0 -7	0 -7	0 -7	0 -6	0 -6	0 -6	0 -5	0.74
	140	0 -13	0 -12	0 -12	0 -12	0 -11	0 -11	0 -11	0 -10	0 -10	0 -10	0 -9	0 -9	0 -9	0 -8	0 -8	0 -8	0 -7	0 -7	0 -7	0 -6	0 -6	0.71
	145	0 -13	0 -13	0 -13	0 -12	0 -12	0 -12	0 -11	0 -11	0 -11	0 -10	0 -10	0 -10	0 -9	0 -9	0 -9	0 -8	0 -8	0 -8	0 -7	0 -7	0 -7	0.69
150	0 -14	0 -14	0 -13	0 -13	0 -13	0 -12	0 -12	0 -12	0 -11	0 -11	0 -11	0 -10	0 -10	0 -10	0 -9	0 -9	0 -9	0 -8	0 -8	0 -8	0 -7	0.67	
155	0 -15	0 -15	0 -14	0 -14	0 -14	0 -13	0 -13	0 -13	0 -12	0 -12	0 -12	0 -11	0 -11	0 -11	0 -10	0 -10	0 -10	0 -9	0 -9	0 -9	0 -8	0.65	
160	0 -16	0 -15	0 -15	0 -15	0 -14	0 -14	0 -14	0 -13	0 -13	0 -13	0 -12	0 -12	0 -12	0 -11	0 -11	0 -11	0 -10	0 -10	0 -10	0 -9	0 -9	0.63	

AVERAGE BEAN WEIGHT (g)

\*For higher moisture contents see next page.

Table for moisture content between 7.4 and 9.2%\*

Temperature (°C)	BEAN MOISTURE CONTENT (%)																					
	7.4	7.5	7.6	7.7	7.8	7.9	8.0	8.1	8.2	8.3	8.4	8.5	8.6	8.7	8.8	8.9	9.0	9.1		9.2		
BEAN COUNT PER 100 g	50	-4 +7	-4 +7	-4 +7	-4 +8	-4 +8	-4 +8	-4 +9	-4 +9	-4 +9	-4 +10	-4 +10	-4 +10	-4 +11	-4 +11	-4 +11	-4 +12	-4 +12	-4 +12	-4 +13	2.00	AVERAGE BEAN WEIGHT (g)
	55	-4 +6	-4 +6	-4 +6	-4 +7	-4 +7	-4 +7	-4 +8	-4 +8	-4 +8	-4 +9	-4 +9	-4 +9	-4 +10	-4 +10	-4 +10	-4 +11	-4 +11	-4 +11	-4 +12	1.82	
	60	-3 +5	-3 +5	-3 +6	-3 +6	-3 +6	-3 +7	-3 +7	-3 +7	-3 +8	-3 +8	-3 +8	-3 +9	-3 +9	-3 +9	-3 +10	-3 +10	-3 +10	-3 +11	-3 +11	1.67	
	65	-3 +4	-3 +5	-3 +5	-3 +5	-3 +6	-3 +6	-3 +6	-3 +7	-3 +7	-3 +7	-3 +8	-3 +8	-3 +8	-3 +9	-3 +9	-3 +9	-3 +10	-3 +10	-3 +10	1.54	
	70	-2 +4	-2 +4	-2 +4	-2 +5	-2 +5	-2 +5	-2 +6	-2 +6	-2 +6	-2 +7	-2 +7	-2 +7	-2 +8	-2 +8	-2 +8	-2 +9	-2 +9	-2 +9	-2 +10	1.43	
	75	-2 +3	-2 +3	-2 +4	-2 +4	-2 +4	-2 +5	-2 +5	-2 +5	-2 +6	-2 +6	-2 +6	-2 +7	-2 +7	-2 +7	-2 +8	-2 +8	-2 +8	-2 +9	-2 +9	1.33	
	80	-2 +2	-2 +3	-2 +3	-2 +3	-2 +4	-2 +4	-2 +4	-2 +5	-2 +5	-2 +5	-2 +6	-2 +6	-2 +6	-2 +7	-2 +7	-2 +7	-2 +8	-2 +8	-2 +8	1.25	
	85	-1 +2	-1 +2	-1 +2	-1 +3	-1 +3	-1 +3	-1 +4	-1 +4	-1 +4	-1 +5	-1 +5	-1 +5	-1 +6	-1 +6	-1 +6	-1 +7	-1 +7	-1 +7	-1 +8	1.18	
	90	-1 +1	-1 +1	-1 +1	-1 +2	-1 +2	-1 +2	-1 +3	-1 +3	-1 +3	-1 +4	-1 +4	-1 +4	-1 +5	-1 +5	-1 +5	-1 +6	-1 +6	-1 +6	-1 +7	1.11	
	95	0 0	0 0	0 +1	0 +1	0 +1	0 +2	0 +2	0 +2	0 +3	0 +3	0 +3	0 +4	0 +4	0 +4	0 +5	0 +5	0 +5	0 +6	0 +6	1.05	
	100	0 -1	0 0	0 0	0 0	0 +1	0 +1	0 +1	0 +2	0 +2	0 +2	0 +3	0 +3	0 +3	0 +4	0 +4	0 +4	0 +5	0 +5	0 +5	1.00	
	105	0 -1	0 -1	0 -1	0 0	0 0	0 0	0 +1	0 +1	0 +1	0 +2	0 +2	0 +2	0 +3	0 +3	0 +3	0 +4	0 +4	0 +4	0 +5	0.95	
	110	0 -2	0 -2	0 -1	0 -1	0 -1	0 0	0 0	0 0	0 +1	0 +1	0 +1	0 +2	0 +2	0 +2	0 +3	0 +3	0 +3	0 +4	0 +4	0.91	
	115	0 -3	0 -2	0 -2	0 -2	0 -1	0 -1	0 -1	0 0	0 0	0 0	0 +1	0 +1	0 +1	0 +2	0 +2	0 +2	0 +3	0 +3	0 +3	0.87	
	120	0 -3	0 -3	0 -3	0 -2	0 -2	0 -2	0 -1	0 -1	0 -1	0 0	0 0	0 0	0 +1	0 +1	0 +1	0 +2	0 +2	0 +2	0 +3	0.83	
	125	0 -4	0 -4	0 -4	0 -3	0 -3	0 -3	0 -2	0 -2	0 -2	0 -1	0 -1	0 -1	0 0	0 0	0 0	0 +1	0 +1	0 +1	0 +2	0.80	
	130	0 -5	0 -5	0 -4	0 -4	0 -4	0 -3	0 -3	0 -3	0 -2	0 -2	0 -2	0 -1	0 -1	0 -1	0 0	0 0	0 0	0 +1	0 +1	0.77	
	135	0 -6	0 -5	0 -5	0 -5	0 -4	0 -4	0 -4	0 -3	0 -3	0 -3	0 -2	0 -2	0 -2	0 -1	0 -1	0 -1	0 0	0 0	0 0	0.74	
	140	0 -6	0 -6	0 -6	0 -5	0 -5	0 -5	0 -4	0 -4	0 -4	0 -3	0 -3	0 -3	0 -2	0 -2	0 -2	0 -1	0 -1	0 -1	0 0	0.71	
	145	0 -7	0 -7	0 -6	0 -6	0 -6	0 -5	0 -5	0 -5	0 -4	0 -4	0 -4	0 -3	0 -3	0 -3	0 -2	0 -2	0 -2	0 -1	0 -1	0.69	
150	0 -8	0 -7	0 -7	0 -7	0 -6	0 -6	0 -6	0 -5	0 -5	0 -5	0 -4	0 -4	0 -4	0 -3	0 -3	0 -3	0 -2	0 -2	0 -2	0.67		
155	0 -9	0 -8	0 -8	0 -8	0 -7	0 -7	0 -7	0 -6	0 -6	0 -6	0 -5	0 -5	0 -5	0 -4	0 -4	0 -4	0 -3	0 -3	0 -3	0.65		
160	0 -9	0 -9	0 -9	0 -8	0 -8	0 -8	0 -7	0 -7	0 -7	0 -6	0 -6	0 -6	0 -5	0 -5	0 -5	0 -4	0 -4	0 -4	0 -3	0.63		

\*For lower moisture content see previous page.

## 9.1 Example for adjusting the roasting conditions

In the previous tables, adjustments are indicated within the cell that corresponds to the intersection of the moisture content (horizontal axis) and the bean size indicated as bean count per 100g (left vertical axis) or bean size indicated as average bean weight (right vertical axis). Within the cell, the top number represents the adjustment in temperature (in °C) while the bottom number represents the adjustment in time (in minutes).

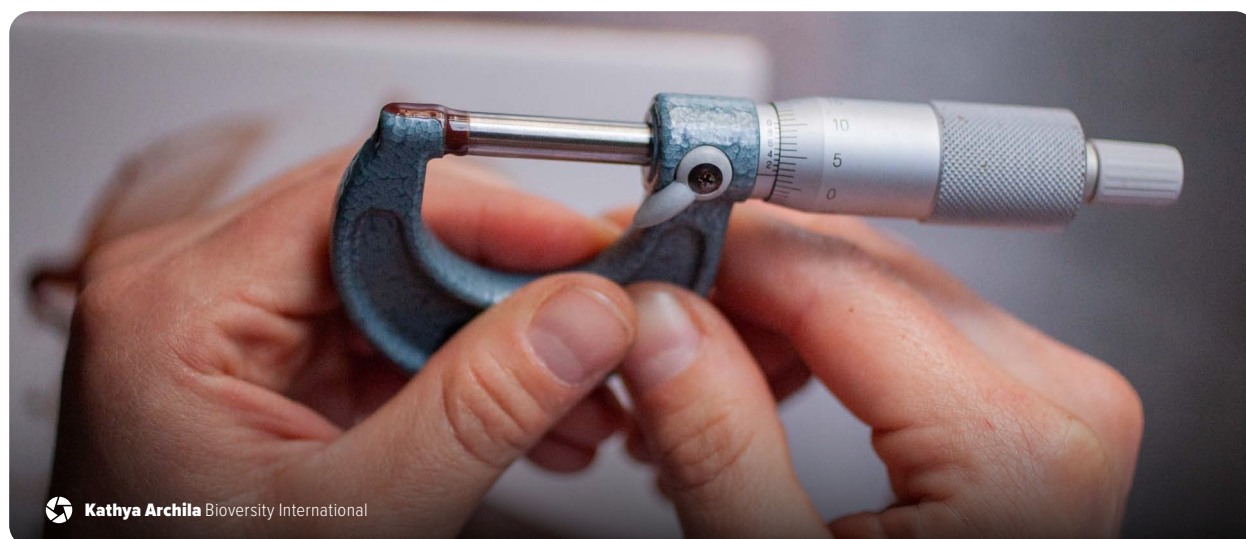
**Table 50.** Example: Beans with the following characteristics and basic roasting conditions.

Aroma from cut test	<b>No significant aroma notes perceived</b>
Moisture content (%)	<b>7.8</b>
Bean count (# of beans in 100g)	<b>65</b>
Basic roasting conditions selected	<b>Full roast at 130°C (266°C) for 25 minutes</b>

In the example from the table above, the information at the intersection of the moisture content and bean count indicate a '-3' at the top and a '+6' at the bottom which mean that three degrees would be deducted from the roasting temperature and six minutes would be added to the roasting time resulting in 127°C for 31 minutes.

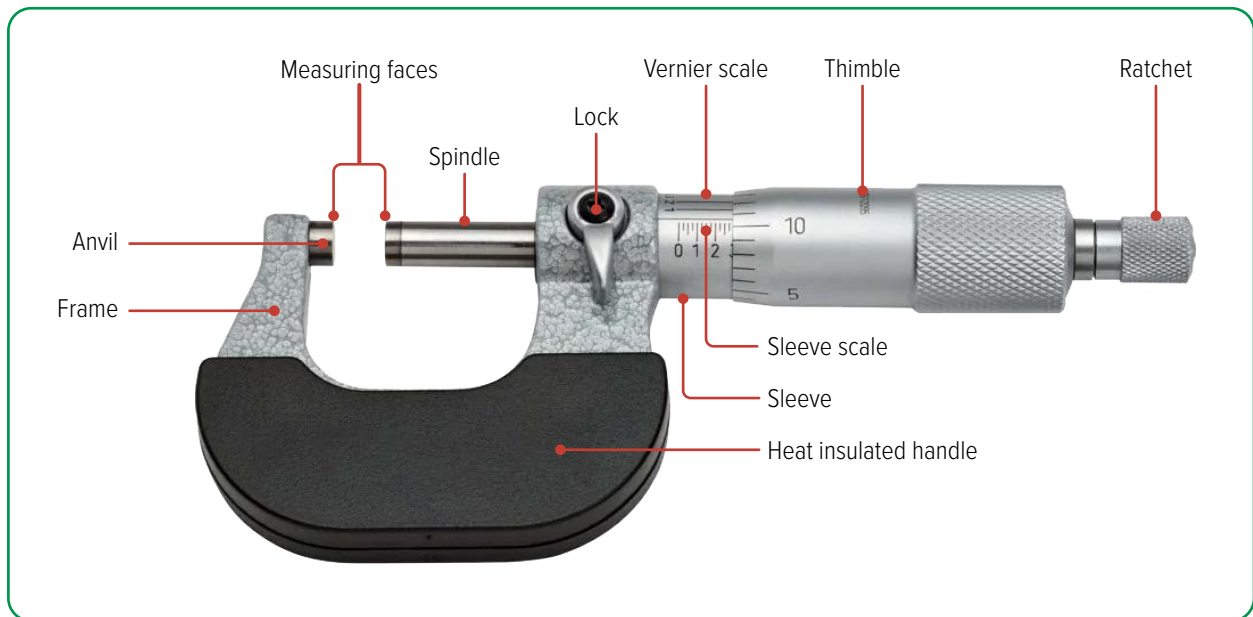
		Temperature (°C)	BEAN MOISTURE CONTENT (%)							
			7.4	7.5	7.6	7.7	7.8	7.9	8.0	8.1
BEAN COUNT PER 100 g	50	-4 +7	-4 +7	-4 +7	-4 +8	-1 +8	-4 +8	-4 +9	-4 +9	
	55	-4 +6	-4 +6	-4 +6	-4 +7	-1 +7	-4 +7	-4 +8	-4 +8	
	60	-3 +5	-3 +5	-3 +6	-3 +6	-3 +6	-3 +7	-3 +7	-3 +7	
	65	-3 +4	-3 +5	-3 +5	-3 +5	-3 +6	-3 +6	-3 +6	-3 +7	

**Figure 36.** Table reading of roasting time and temperature adjustments for cacao beans at 7.8% moisture and a count of 60 beans/100g.



## Annex 10. Use of micrometer to measure cacao mass particle size

The Vernier micrometer should cover the range of 0–25mm and have an accuracy of 0.001mm.



**Figure 37.** Main parts of a standard Vernier micrometer.

The figure above describes the parts of a Vernier micrometer. The general procedure for using a micrometer are detailed below. However, it is recommended to refer to the user manual specific to the model of the micrometer to be used.

### 10.1 Setting the micrometer to zero

1. Open the micrometer between 1–1.5cm to access the measuring faces easily.
2. Clean both the top and bottom measuring faces with tissue paper or a soft paper towel.
3. Close the micrometer by spinning down the thimble.
4. When the space between the measuring faces is around 300 $\mu$ m, slow down the thimble spinning speed and completely close the micrometer gradually and smoothly in a single smooth stroke.
5. Read the micrometer. It should read zero.
6. If the micrometer does not read zero, clean the measuring faces:
  - a. Open the micrometer.
  - b. Insert a clean sheet of printing paper.
  - c. Close the micrometer gently and pull the paper out.
7. Repeat the closing until it reads zero. If it still does not read zero, follow the user manual to adjust the deviation.

## 10.2 Measuring cacao mass particle size

1. Dilute a portion of liquid cacao mass with mineral oil in a proportion of 1:1 (weight/weight) and mix on a warm white tale to separate the agglomerated particles as shown in the figure below.

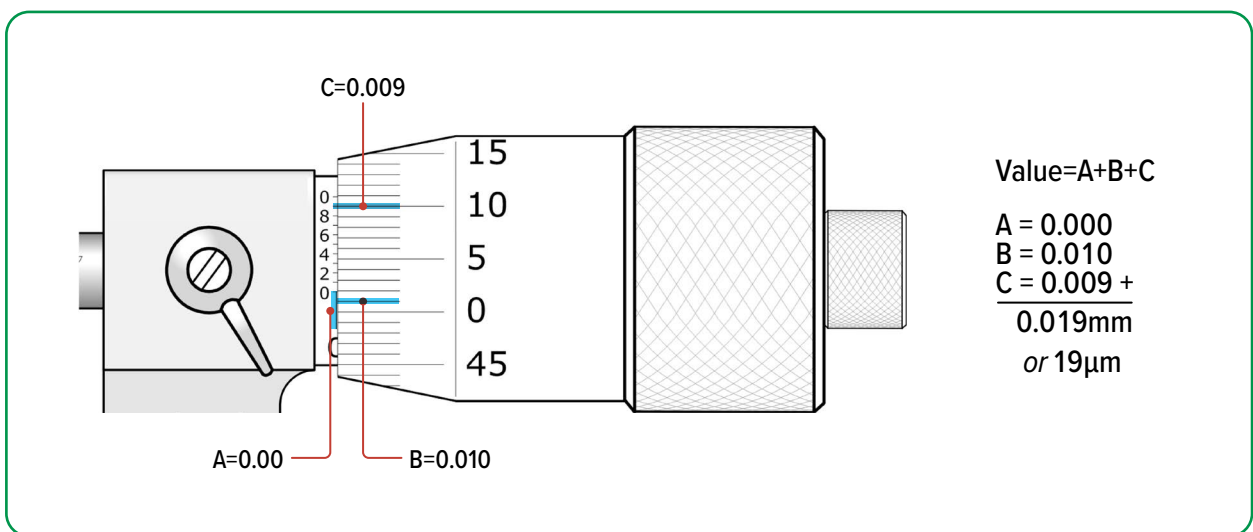


**Figure 38.** Cacao mass preparation procedure using mineral oil, for measuring particle size with a micrometer (Bioversity International, Archila, 2022).

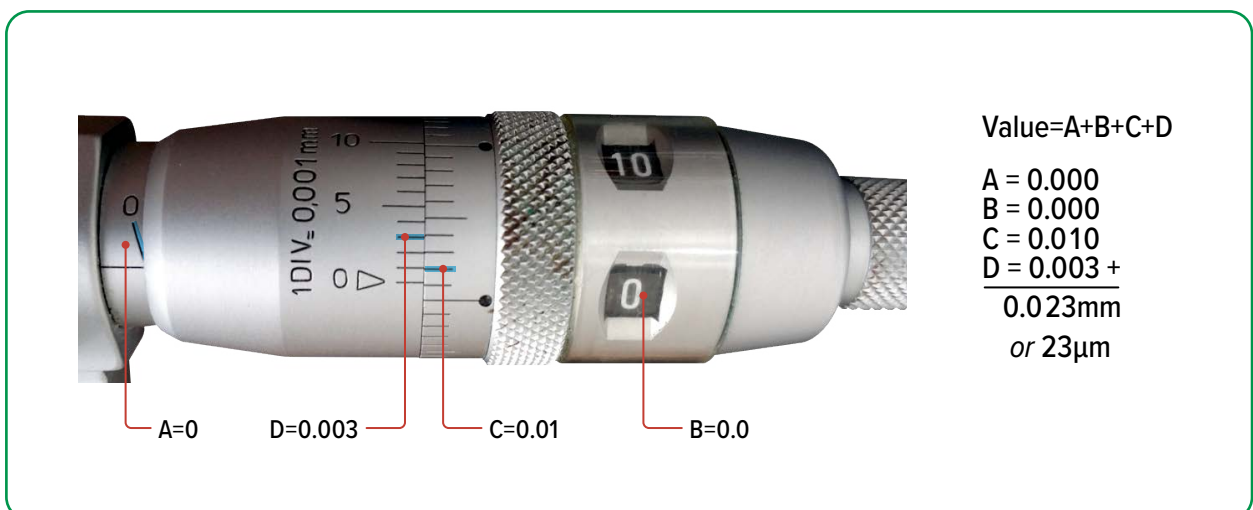
2. Hold the micrometer in the vertical position so that the measuring faces are horizontally oriented and the spindle is on the bottom. Place a drop of the cacao mass oil mixture on the spindle measuring face.
3. Close the micrometer by spinning down the barrel.
4. When the space between the anvil and spindle is around 300µm, slow down the barrel spinning speed and close the micrometer gradually and smoothly in a single smooth stroke.
5. Read the values. The steps to read values are described in 10.3.1 and 10.3.2 below.

### 10.3 Analogue micrometer

In an analogue micrometer the values indicated in each scale are added to obtain the measurement. Figure 39 and Figure 40 show two examples of readings with a standard and high precision Vernier micrometer.



**Figure 39.** Reading analogue micrometers with 0.001mm resolution. Standard Vernier micrometer ([stefanelli.eng.br/es](http://stefanelli.eng.br/es)).



**Figure 40.** Reading analogue micrometers with 0.001mm resolution: high-precision Vernier micrometer (Seguine, 2014).

The steps to read measurements in a standard and high precision micrometer with Vernier are as follows:

### 10.3.1 For a standard Vernier micrometer (Figure 39):

1. Read value A, in 1mm units, using the scale on the sleeve; the value is indicated by the last line before the thimble starts.
2. Read value B, in 0.010mm units, using the scale on the thimble. The value is indicated by the closest line that is below the zero line of the sleeve scale.
3. Read value C, in 0.001mm units, using the Vernier scale on the sleeve. The value is indicated by the line that perfectly matches one line of the thimble.
4. Add the values A, B and C to get the total measurement.

### 10.3.2 For a high-precision Vernier micrometer (Figure 40):

1. Read value A, in 1mm units, using the scale on the sleeve. The value is indicated by the last line before the thimble starts.
2. Read value B, in 0.1mm units, directly on the numerical display that is on or right below the zero line (on the left).
3. Read value C, in 0.01mm units, using the scale on the right of the thimble. The value is indicated by counting the small lines between the zero line (on the left) and the next numbered (long) line.
4. Read value D, in 0.001mm units, using the scale on the left part of the thimble. The value is indicated by the first line that perfectly matches one line of the left scale.
5. Add the values A, B, C and D to get the total measurement.

## 10.4 Digital micrometer

In a digital micrometer, read the total value on the display (Figure 72c). There are some digital micrometers where the third decimal place (0.001mm units) is only readable in the Vernier scale (Figure 72d).



**NOTE:** In all cases, once the use has been completed, turn off the micrometer and use a tissue paper or soft paper towel to clean micrometer measuring faces. If needed, a sheet of printing paper.



## Annex 11. Examples of calculation of ingredients for chocolate processing

Using desired total amount of chocolate as basis for calculation:

Definition of variables	Formula
<ul style="list-style-type: none"> <li><math>W_{CHOCOLATE}</math>: weight of chocolate amount to be produced (g)</li> <li><math>p</math>: percentage of ingredient as given in formula (%)</li> <li><math>w</math>: weight of ingredient (g)</li> </ul>	$w = \frac{W_{CHOCOLATE}}{100} \times p$
<p>Example: You will produce 3000.0g of chocolate with the recipe indicated in Table 31, Section 14.4.1.</p> <ul style="list-style-type: none"> <li><math>W_{CHOCOLATE} = 3000.0\text{g}</math></li> <li>Cacao mass <math>w = \frac{W_{CHOCOLATE}}{100} \times p = \frac{3000.0\text{g}}{100} \times 63.00 = 1890.0\text{g}</math></li> <li>Sugar <math>w = \frac{W_{CHOCOLATE}}{100} \times p = \frac{3000.0\text{g}}{100} \times 30 = 900\text{g}</math></li> <li>Cacao butter <math>w = \frac{W_{CHOCOLATE}}{100} \times p = \frac{3000.0\text{g}}{100} \times 7 = 210\text{g}</math></li> </ul>	

Figure 41. Ingredient calculation examples with total desired amount of chocolate as the basis.

Calculating the ingredients for chocolate processing using the desired total amount of chocolate as a basis, is as follows::

Definition of variables	Formula
<ul style="list-style-type: none"> <li><math>W_{CM}</math>: weight of cacao mass (g)</li> <li><math>p_{CM}</math>: percentage of cacao mass as given in formula (%)</li> <li><math>w</math>: weight of ingredient (g)</li> <li><math>p</math>: percentage of ingredient as given in formula (%)</li> </ul>	$w = \frac{W_{CM}}{100} \times p$
<p>Example: You have 2150.0g of cacao mass in the melanger and will produce chocolate with it using the recipe indicated in Table 31, Section 14.4.1.</p> <ul style="list-style-type: none"> <li><math>W_{CM} = 2150.0\text{g}</math></li> <li>Cacao butter <math>w = \frac{W_{CM}}{p_{CM}} \times p = \frac{2150.0\text{g}}{63} \times 7 = 238.9\text{g}</math></li> <li>Sugar <math>w = \frac{W_{CM}}{p_{CM}} \times p = \frac{2150.0\text{g}}{66} \times 30 = 1023.8\text{g}</math></li> <li>The total amount of chocolate to be produced is the sum of all ingredients:  <math>= 2150.0\text{g} + 238.9 + 1023.8 = 3412.7\text{g}</math></li> </ul>	

Figure 42. Ingredient calculation examples with cacao mass as the basis.

## Annex 12. Heating and cooling chocolate manually during tempering process

**Table 51.** Options for heating and cooling chocolate manually: advantages and disadvantages.

Option	Heating	Cooling	Advantages	Disadvantages
1	Hot water-bath	Marble slab	<ol style="list-style-type: none"> <li>1 Very fast</li> <li>2 Heating is continuous</li> <li>3 You can continuously control the temperature while heating</li> <li>4 You can continuously stir sample while heating</li> </ol>	<ol style="list-style-type: none"> <li>1 Risk of getting drops of water into chocolate while cooling</li> <li>2 Cooling takes longer than with marble slab</li> </ol>
2	Hot water-bath	Cool water-bath	<ol style="list-style-type: none"> <li>1 Heating is gradually and continuous</li> <li>2 You can continuously control the temperature while heating</li> <li>3 You can continuously stir sample while heating</li> <li>4 You have a better control of temperature while cooling</li> <li>5 Applicable at any room temperature</li> </ol>	<ol style="list-style-type: none"> <li>1 Risk of getting drops of water into chocolate while cooling</li> <li>2 Cooling takes longer than with marble slab</li> </ol>
3	Microwave	Marble slab	<ol style="list-style-type: none"> <li>1 Fast</li> <li>2 No water is used, so no risk of water drops to fall into chocolate</li> </ol>	<ol style="list-style-type: none"> <li>1 If room temperature is over 20°C (68°F) the marble slab can get warm and no longer cool the chocolate, or take a long time</li> <li>2 Risk of burning sample</li> <li>3 It is not possible to control the temperature continuously</li> </ol>
4	Microwave	Cool water-bath	<ol style="list-style-type: none"> <li>1 Better control of temperature while cooling</li> </ol>	<ol style="list-style-type: none"> <li>1 Applicable at any room temperature</li> <li>2 Risk of burning sample</li> <li>3 Control of temperature while heating is only possible between heating intervals</li> </ol>

## Annex 13. Tempering troubleshooting

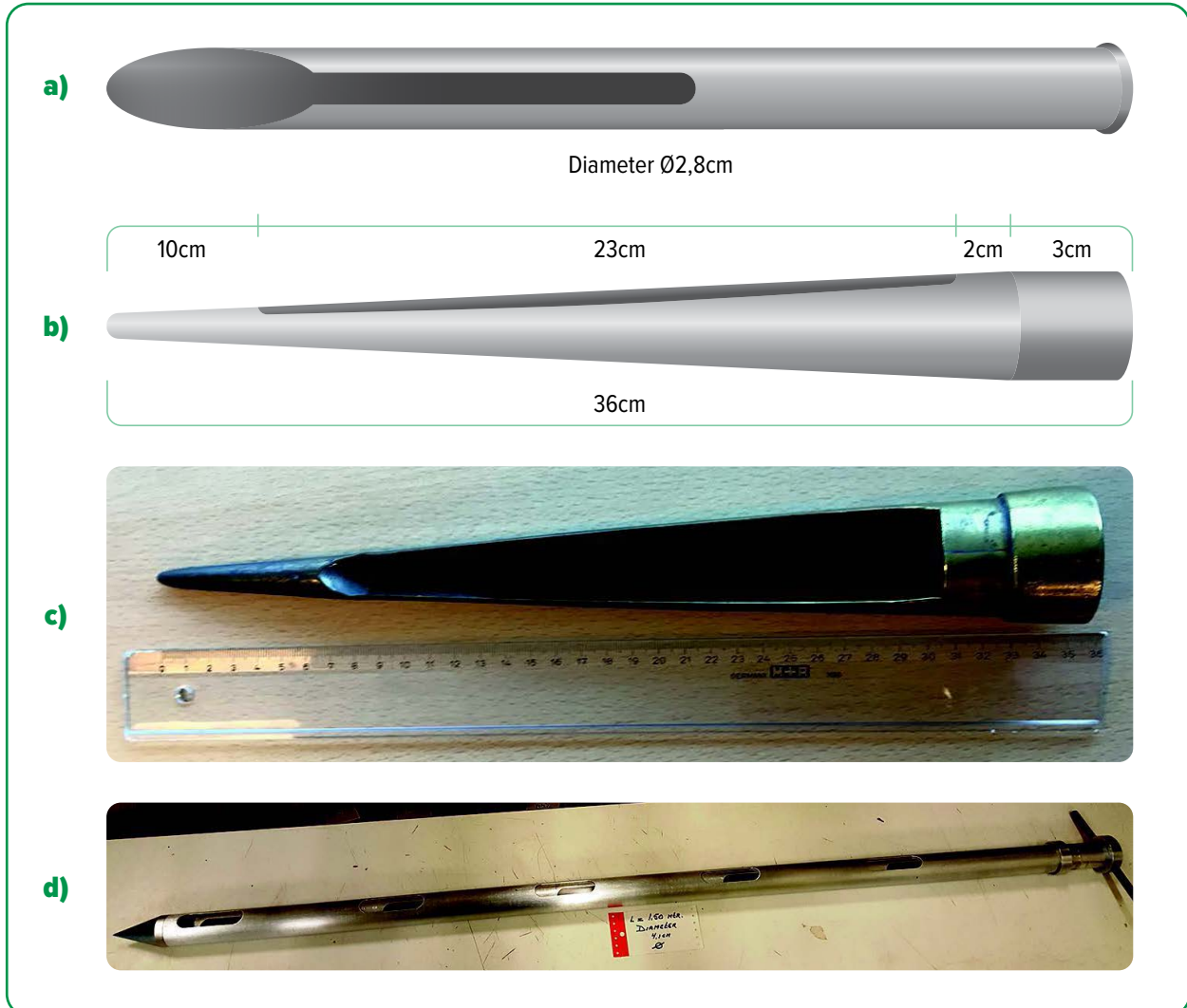
**Table 52.** Troubleshooting for the tempering process.

<b>Problem</b>	<b>Probable solution</b>
<b>The chocolate burned while heating it in the microwave</b>	<ul style="list-style-type: none"> <li>• The burned chocolate is unrecoverable. Throw it away or use it for baking.</li> <li>• Reduce the time of the heating intervals.</li> </ul>
<b>Heating the chocolate above 50°C (122°F) while melting</b>	<ul style="list-style-type: none"> <li>• If the chocolate is not burned (smells burned and/or small hard particles formed) just continue the process.</li> </ul>
<b>Drops of water fell into melted chocolate</b>	<ul style="list-style-type: none"> <li>• Try to spoon out the chocolate surrounding the water drops. If not possible, continue working if the chocolate is still fluid but it is likely that the temper will not be homogeneous.</li> <li>• If the chocolate is not fluid enough, you will not be able to recover it.</li> <li>• Throw it away or use it for baking or beverages.</li> </ul>
<b>Cooling the chocolate below 26–27°C (78.8–80.6°F) while tempering with the cooling method</b>	<ul style="list-style-type: none"> <li>• Continue heating it to 31–33°C (87.8–91.4°F). The process will take longer, the time will depend on how cold the chocolate was.</li> </ul>
<b>Heating the chocolate above 33°C (91.4°F) while tempering with the cooling method</b>	<ul style="list-style-type: none"> <li>• Start over. Melt it completely heating it to 45–50°C (113–122°F) and repeat the process.</li> </ul>
<b>Water drops appeared on the chocolate pieces after taking them out of the fridge</b>	<ul style="list-style-type: none"> <li>• The possible causes are:               <ul style="list-style-type: none"> <li>» Air humidity is too high</li> <li>» Room temperature is too high</li> <li>» The chocolates were cooled beyond the time needed to just solidify.</li> </ul> </li> <li>• Dry the chocolates with a paper towel. These will lose the temper soon and are not recoverable.</li> <li>• For your next batch:               <ul style="list-style-type: none"> <li>» Check the room humidity and temperature. Set them to &lt;70% RH and 18–20°C (64.4–68°F)</li> </ul> </li> <li>• If you cannot change the humidity and temperature conditions of the room, try to cool the chocolates only for one minute and then take them out. Identify the coolest place in the room and leave them there until they solidify.</li> </ul>

## Annex 14. All equipment, tools and materials

The equipment, tools and materials described in sections A, B, C and D are pictured below for visual purposes.

### 14.1 Sampling equipment, tools and materials



**Figure 43.** Examples of spears for sampling beans in bags (a, b and c) and for sampling of bulk beans (d). (ISO, 2292:2017).



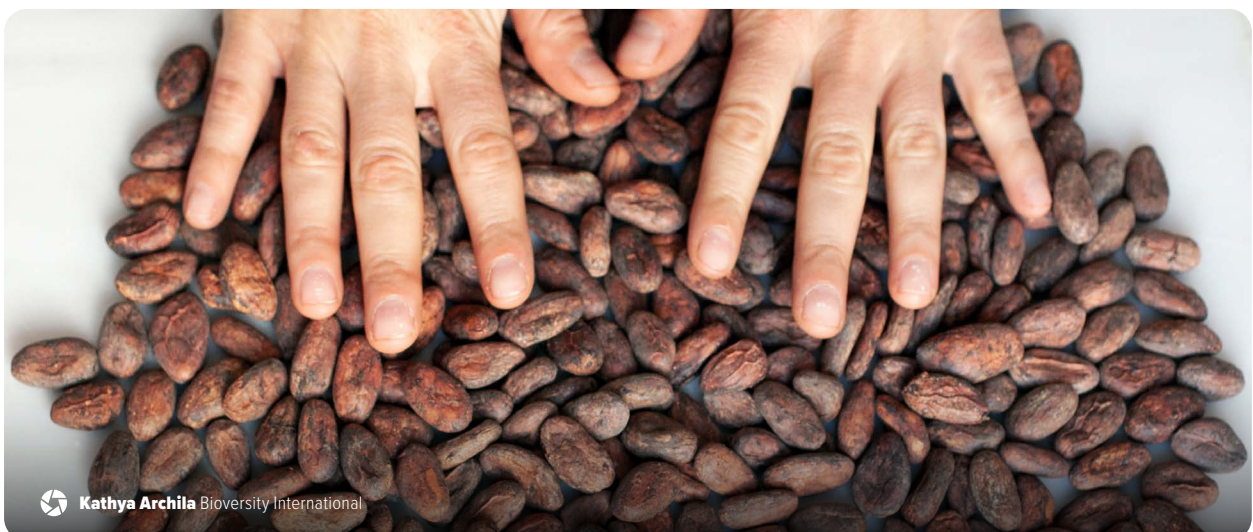
**Figure 44.** Examples of sampling scoops for bulk sampling.

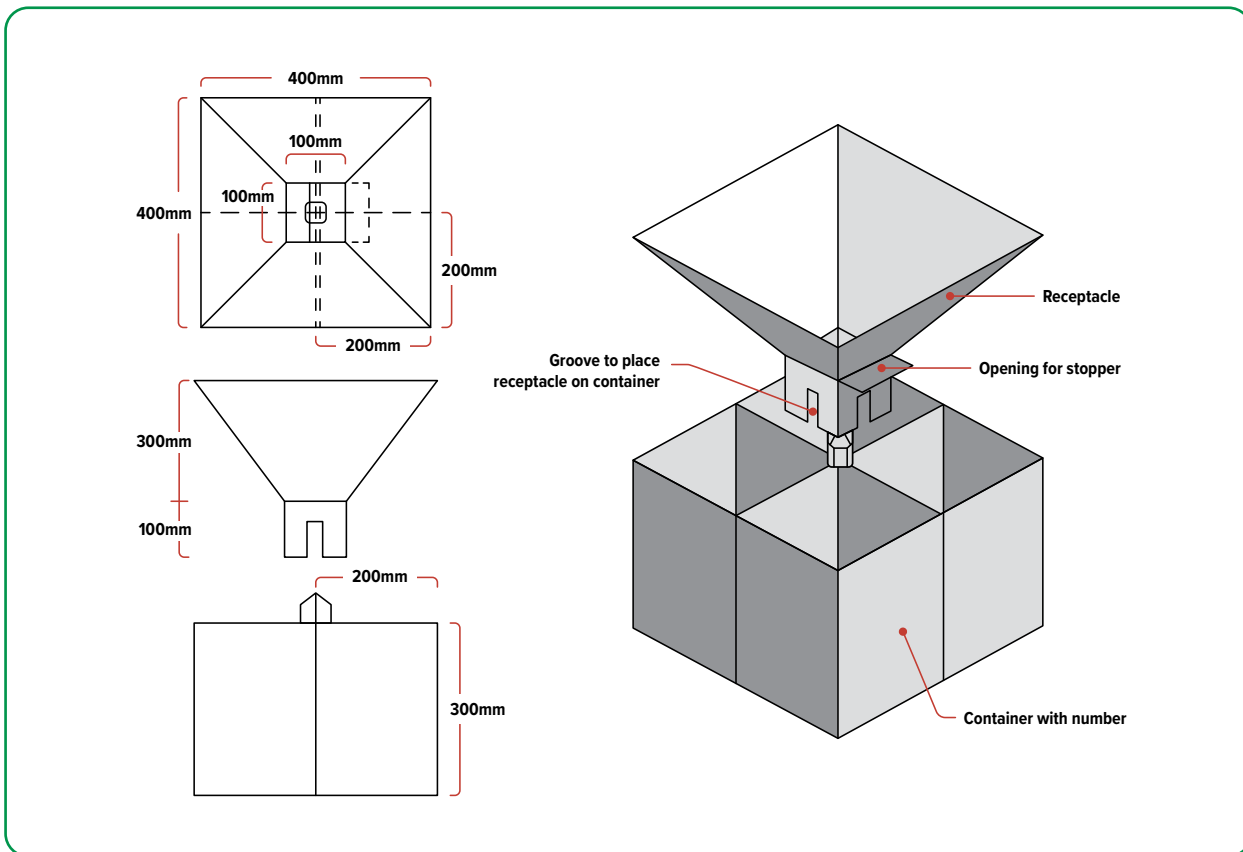


**Figure 45.** Examples of weighing scales with at least 2kg capacity: a) analog and b) digital. ([soehnle-professional.com/en](http://soehnle-professional.com/en); [mt.com](http://mt.com)).



**Figure 46.** Example of (a) stainless steel and (b) plastic storage vessels for preparing the composite sample from primary or incremental samples. Storage containers must be equipped with lids to minimise moisture loss/gain, foreign odour/off-odour absorption, and insect and/or rodent infestation. ([sampling.com](http://sampling.com); [mannlaketld.com](http://mannlaketld.com)).





**Figure 47.** Interior of a quartering tool showing the quartering irons (MS, 230:2007).

**Table 53.** Examples of specifications for a sampling spear for bagged and bulk sampling (ISO 2292:2017).

Parameters	Sampling from bags	Sampling from bulk
Length	From 35 to 45cm	From 150 to 250cm
Diameter (inside)	From 2.8 to 3.0cm	From 3.5 to 4.1cm
Diameter (outside)	From 3.0 to 3.2cm	From 3.6 to 4.2cm
Thickness	Max 2mm	Max 2mm
Weight	Approximately 230g	No recommendation
Material	Aluminium/alloy	Aluminium
Angle	Approximately 20°	If applicable approx. 20°

**Table 54.** Examples of specifications for handheld sampling scoops for bulk sampling (Sampling Systems Ltd., 2018).

Part No.	Nominal capacity (g)	Body width (mm)	Body length (mm)	Overall length (mm)
A643-100	100	60	115	180
A643-200	200	75	135	205
A643-300	300	90	150	230
A643-500	500	110	180	270

**Table 55.** Examples of specifications for stainless steel storage vessels for composite samples (Sampling Systems Ltd., 2018).

<b>304 Stainless steel Part No.</b>	<b>316L Stainless steel Part No.</b>	<b>Nominal capacity (kg)</b>	<b>Height (mm)</b>	<b>Diameter (mm)</b>
<b>A434-1</b>	<b>A446-1</b>	1.0	155	100
<b>A434-2</b>	<b>A446-2</b>	2.0	175	130
<b>A434-3</b>	<b>A446-3</b>	3.0	185	155
<b>A434-5</b>	<b>A446-5</b>	5.0	240	175
<b>A434-6</b>	<b>A446-6</b>	6.0	280	175
<b>A434-8</b>	<b>A446-8</b>	8.0	285	200
<b>A434-10</b>	<b>A446-10</b>	10.0	295	220
<b>A434-12</b>	<b>A446-12</b>	12.5	285	240
<b>A434-15</b>	<b>A446-15</b>	15.0	285	270

## 14.2 Equipment, tools and materials for assessing moisture content



**Figure 48.** a) oven, b) desiccator; and c) metal dishes, for measuring moisture content using the oven-drying method ([matest.com](http://matest.com); [coleparmer.co.uk](http://coleparmer.co.uk); [certifiedmtp.com](http://certifiedmtp.com)).



**Figure 49.** a) Cacao-specific moisture metre Aqua-Boy KAM III with cup electrode 202 and b) stab electrode 209 b, cable and holder. ([aqua-boy.co.uk](http://aqua-boy.co.uk)).

**Table 56.** Specifications for Aqua-Boy KAM III moisture metre (Enercorp Instruments Ltd, 2008).

Built-in scale	2%–20%
Size	6 5/8x 4 1/2 x 2'
Length	170mm
Width	115mm
Height	50mm
Power source	1x9V Battery
Accuracy	±0.1%
Reproducibility	0.2%
Display	Analogue



**Table 57.** Specifications for Dickey-John Mini GAC 2500 moisture metre (Dickey-John, 2017).

Operating temperature range	5–45°C (40–113°F)
Validated grain temperature range	5–45°C (40–113°F)
Operating grain temperature range	0–50°C (32–122°F)
Recommended maximum temperature difference) between analyser and grain)	20°C (36°F)
Humidity	5–95%, non-condensing
Weight	1.1kg (2lb 7oz)
Power source	A 9V alkaline battery is included. A low battery indicator on the display will identify when replacement is necessary.



**Figure 50.** Dickey-John Mini GAC 2500 moisture metre with loader ([dickey-john.com](http://dickey-john.com)).



**Figure 51.** Wile Coffee and Cocoa moisture metre ([wile.fi](http://wile.fi)).

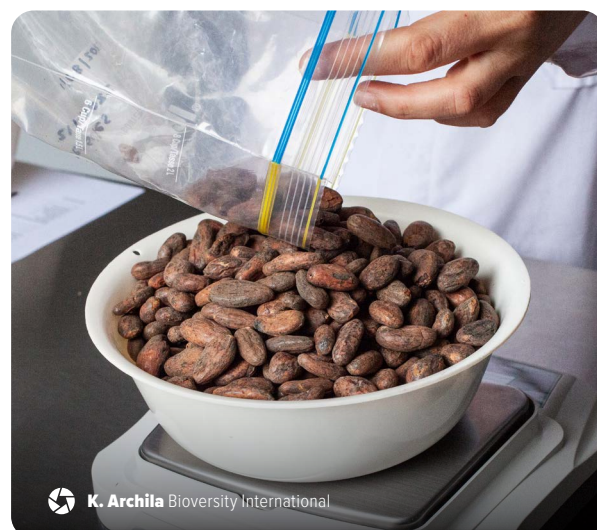
**Table 58.** Specifications for Wile Coffee and Cocoa moisture metre (Farmcomp Oy, 2011).

Range moisture measurement	1%–38%
Repeatability	+/-0,5 moisture percent
Power source	9V battery of the type 6F22 or a similar alkaline battery is included. The metre gives a warning about the low battery voltage
Calculation	Average calculation
Memory capacity	Average calculation memory maximum 99 results

### 14.3 Equipment, tools and materials for determining cleaning loss and bean size



**Figure 52.** Example of an electronic top-loading scale for weighing the samples ([soehnle-professional.com/en](http://soehnle-professional.com/en)).



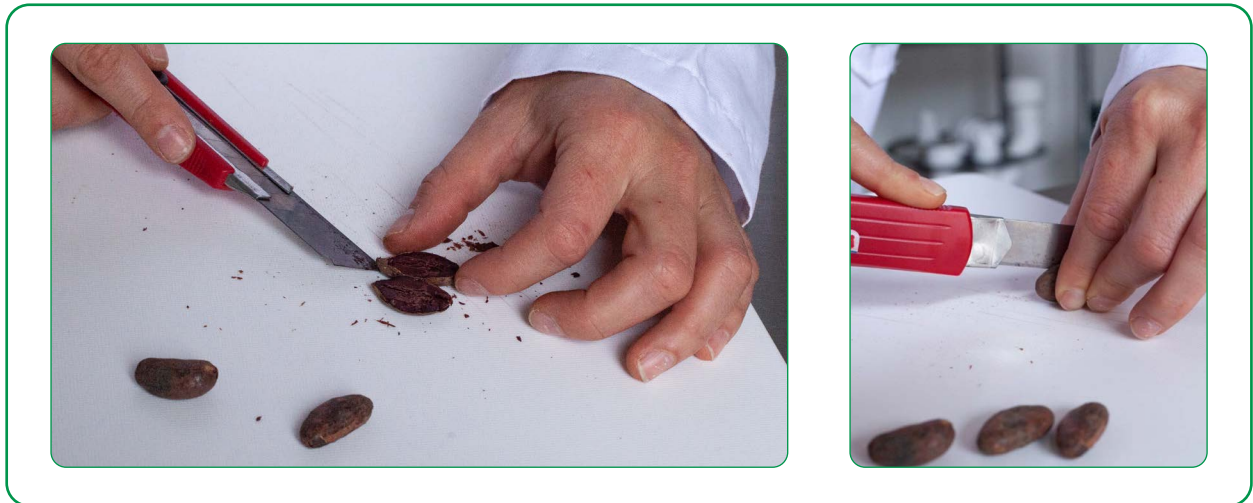


**Figure 53.** a) Test sieve for separating cacao beans from dirt particles; b) mechanical sieve shaker for bean size distribution measurement and analysis ([lavallab.com](http://lavallab.com)).

**Table 59.** Sieve mesh size comparison chart of screens appropriate for cleaning of cacao beans (Gilson Company Inc., 2018).

<b>ASTM E11</b>		<b>ISO 3310-1:2016</b>
<b>Standard (mm)</b>	<b>Alternate (in)</b>	<b>Size (mm)</b>
16.0	5/8"	16.0
-	-	14.0
13.2	0.530"	13.2
12.5	1/2"	12.5
11.2	7/16"	11.2
-	-	10.0
9.5	3/8"	9.5
-	-	9.0
8.0	5/16"	8.0
-	-	7.1
6.7	0.265"	6.7
6.3	1/4"	6.3
5.6	No.3 1/2"	5.6
-	-	5.0
4.75	No.4	4.75
-	-	4.50
4.00	No.5	4.00
3.55	-	3.55

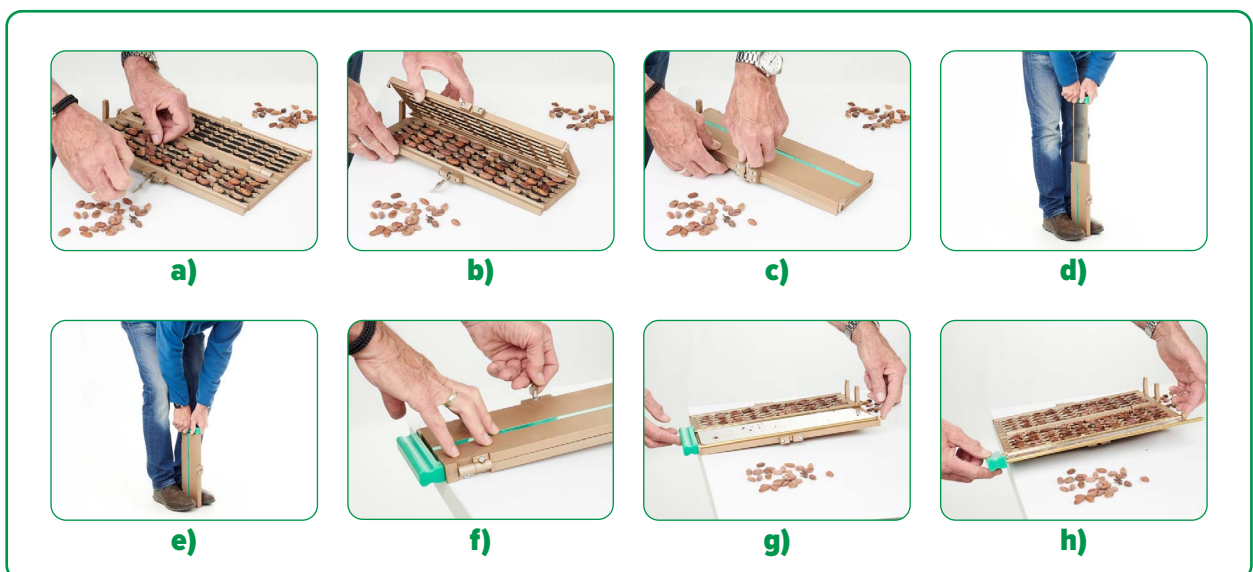
## 14.4 Equipment, tools and materials for performing cut tests



**Figure 54.** Example of cutting beans individually with a knife (Bioversity International, Archila, 2022).

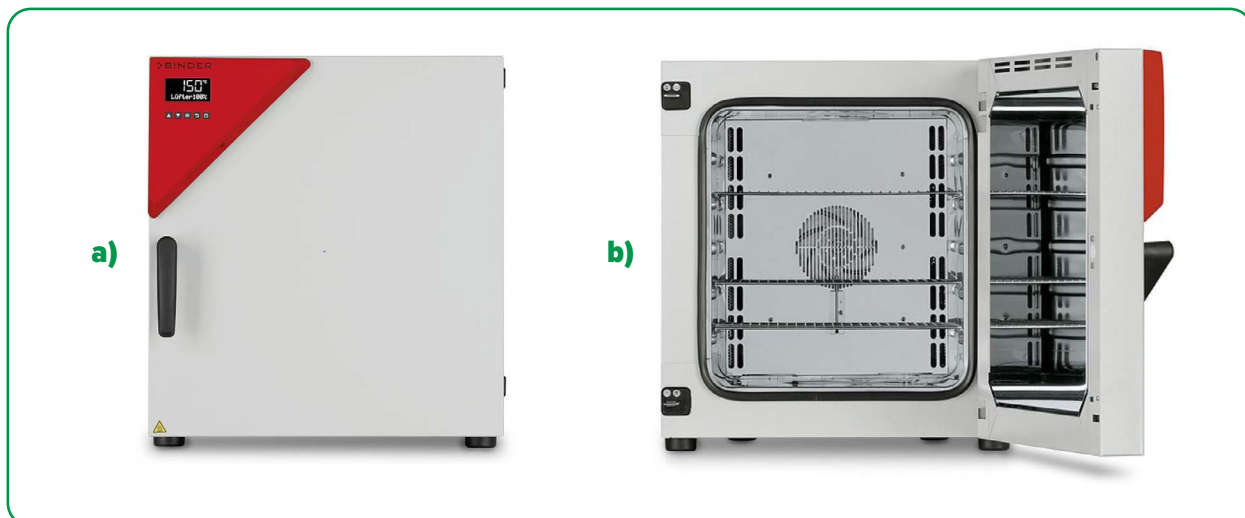


**Figure 55.** Examples of classification boards for cut beans (Neuhaus, 2006; Neuhaus, 2007).



**Figure 56.** Example of bean cutting procedure using a Magra 14 guillotine cutter from Tesserba ([teserba.ch](https://www.teserba.ch)).

## 14.5 Equipment, tools and materials for roasting



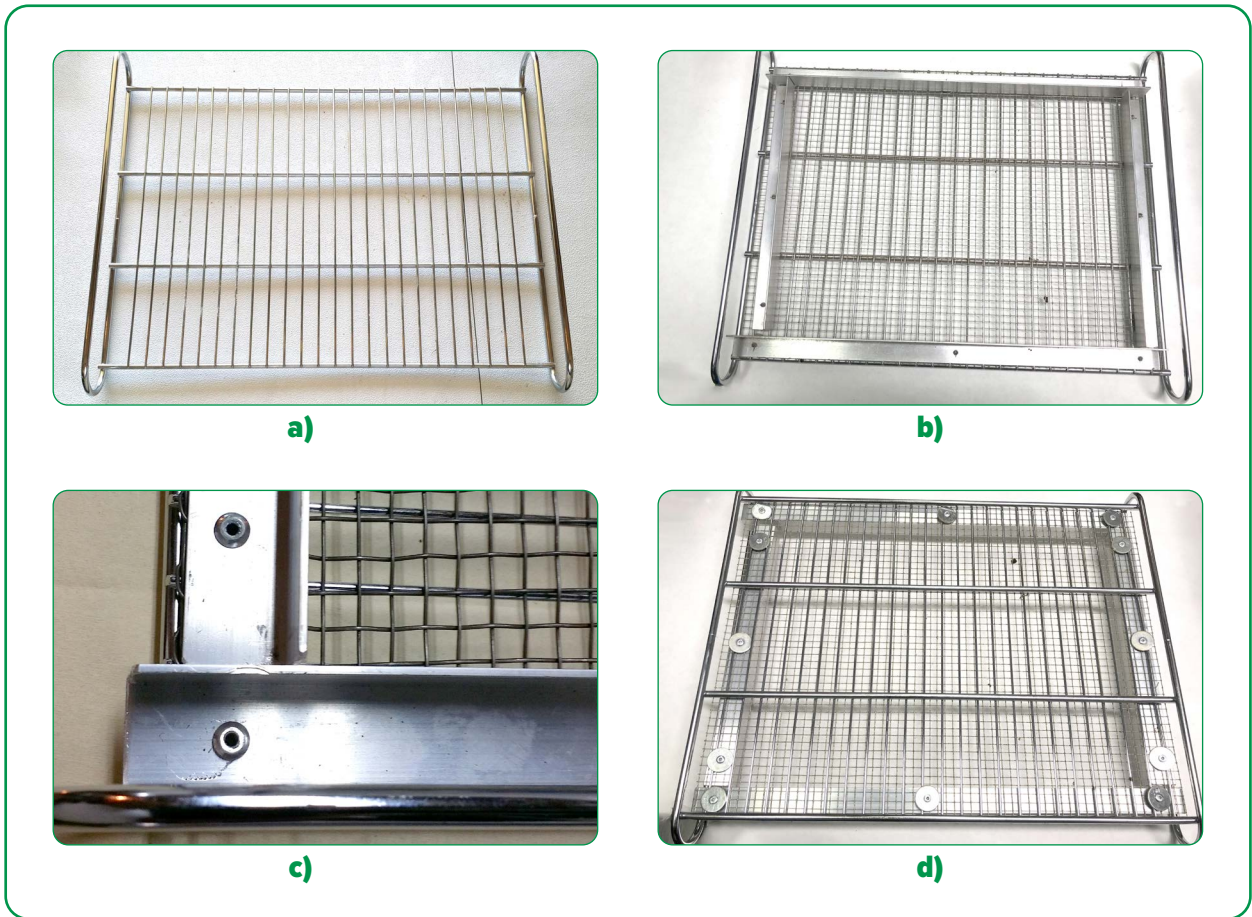
**Figure 57.** a) Image of Binder® Oven FD 56 closed and b) open. Notice the symmetrical position of the trays above and below the fan opening ([binder-world.com](http://binder-world.com)).

**Table 60.** Examples of ovens that comply with the recommended specifications.

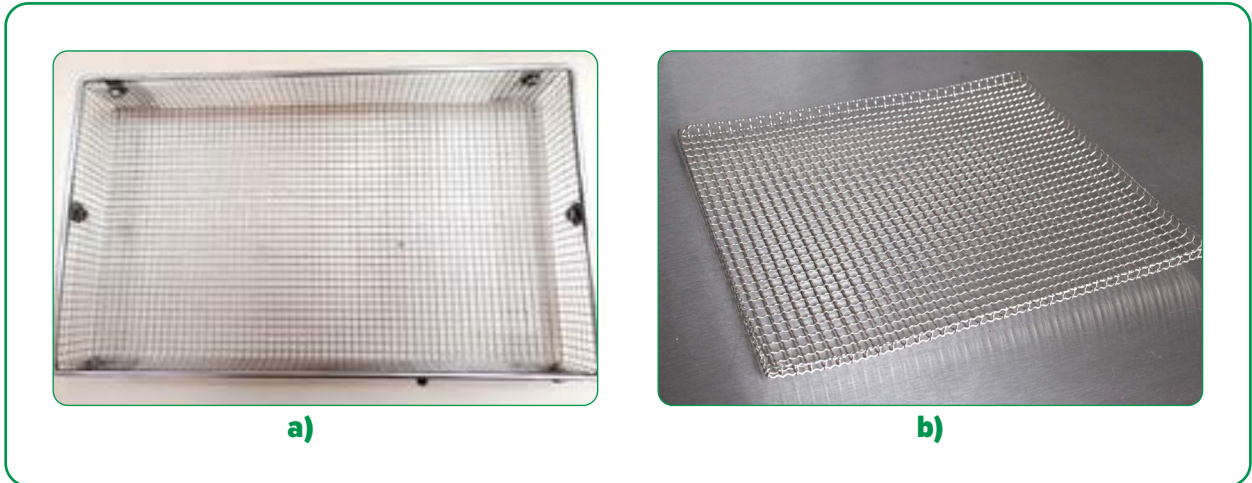
Brand	Model	Website
Gemmy	YCO-010	<a href="http://gemmy.com.tw">gemmy.com.tw</a>
Binder	FD 56 / FD 53	<a href="http://binder-world.com">binder-world.com</a>
France Etuves	XU 112	<a href="http://france-etuves-store.com">france-etuves-store.com</a>

**Table 61.** Specifications for the Binder® Oven FD 56 as an example (Binder GmbH, 2017).

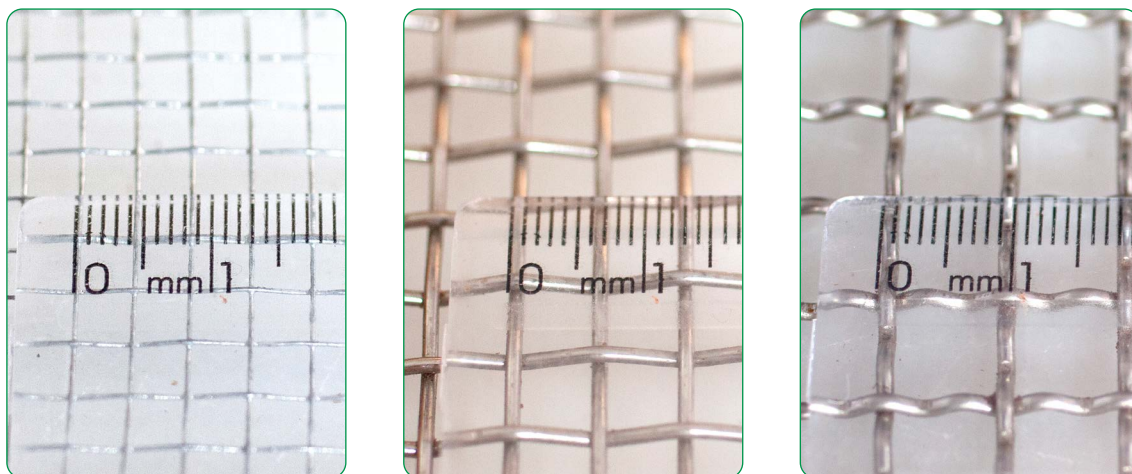
Parameter	Specification
Type	Forced convection
Variable control	Temperature and time digital setting
Temperature range	Ambient +10–300°C (+50–572°F)
Temperature variation at 150°C (302°F)	1.7°C (3.6°F)
Temperature fluctuation at 150°C (302°F)	±0.3°C (±0.6°F)
Recovery time after 30 seconds door open at 150°C (302°F)	4 minutes
Temperature uniformity	≤3.0°C (≤5.4°F)
Internal dimensions	400 width×345 depth×440 height (in mm)
Tray quantity	2–4
Tray positions	Symmetrically above and below the fan opening



**Figure 58.** a) Original Binder<sup>®</sup> oven tray; b) same tray screen covered; c) detail of screen frame corner; d) back of adapted tray. Notice the edge lips that allow the entire tray to be used for roasting but not risk any beans falling off (Seguine, 2014).



**Figure 59.** Other stainless steel wire roasting trays adapted to suit the area of the oven tray (a) Sukha and Ali, 2016; b) Bioversity International, Archila, 2022.



**Figure 60.** Differences in screen open area are defined by two parameters: mesh size and wire diameter. ([metalmesh.com.au/glossary/](http://metalmesh.com.au/glossary/)).

**Table 62.** Standard specifications for a square wire mesh that are compliant with the ISCGF standards for constructing mesh-type oven trays (Metals Service Center Institute, 2022).

<b>Mesh size (mm)</b>	<b>Wire diameter (mm)</b>	<b>Opening size (mm x mm)</b>	<b>Open area (%)</b>
<b>3x3</b>	1.2	7.3x7.3	74%
	1.0	7.4x7.4	77%
	0.9	7.5x7.5	80%
	0.8	7.6x7.6	82%
<b>4x4</b>	1.2	5.2x5.2	66%
	1.0	5.3x5.3	70%
	0.9	5.5x5.5	74%
	0.8	5.5x5.5	76%
	0.7	5.6x5.6	79%
	0.6	5.7x5.7	81%
<b>5x5</b>	1.0	4.0x4.0	63%
	0.9	4.2x4.2	68%
	0.8	4.3x4.3	71%
	0.7	4.4x4.4	74%
	0.6	4.4x4.4	77%
	0.6	4.5x4.5	78%
<b>6x6</b>	0.9	3.4x3.4	63%
	0.8	3.4x3.4	66%
	0.7	3.5x3.5	70%
	0.6	3.6x3.6	73%
	0.6	3.7x3.7	75%
	0.5	3.7x3.7	78%

**Table 63.** Examples of commercial wire mesh that can be used for constructing oven trays.

<b>Manufacturer</b>	<b>Construction type</b>	<b>Primary material</b>	<b>Mesh size (mm x mm)</b>	<b>Opening size (mm x mm)</b>	<b>Wire diameter (mm)</b>	<b>Open area (%)</b>	<b>Web page</b>
McNICHOLS	Welded	Galvanised steel	4x4	5.7x5.7	0.6	81	<a href="http://mcnichols.com">mcnichols.com</a>
	Woven	Galvanised steel	4x4	5.7x5.7	0.6	81	
	Woven	Stainless steel	4x4	5.6x5.6	0.7	79	
	Welded	Stainless steel	4x4	5.5x5.5	0.8	76	
	Woven	Stainless steel	4x4	5.5x5.5	0.9	74	
	Woven	Aluminum	4x4	5.2x5.2	1.2	66	
EDWARD J. DARBY & SON INC.	Welded	Stainless steel	3x3	7.5x7.5	1.0	79	<a href="http://catalog.darbywiremesh.com">catalog.darbywiremesh.com</a>
	Woven / Welded	Plain steel / Carbon steel	3x3	7.3x7.3	1.2	74	
	Woven	Bronze	4x4	5.5x5.5	0.9	74	
	Welded	Stainless steel	3x3	7.3x7.3	1.2	74	
	Woven / Welded	Plain steel / Carbon steel	4x4	5.3x5.3	1.0	70	
	Woven	Aluminum	5x5	4.2x4.2	0.9	68	
	Woven / Welded	Plain steel / Carbon steel	4x4	5.2x5.2	1.2	66	
	Woven	Galvanised steel	6x6	3.7x3.7	0.5	78	
	Welded	Stainless steel	3x3	7.3x7.3	1.2	74	
	Woven	Stainless steel	4x4	5.5x5.5	0.9	74	
MCMASTER-CARR	Woven	Copper	4x4	5.2x5.2	1.2	66	<a href="http://mcmaster.com">mcmaster.com</a>
	Woven	Brass	4x4	5.2x5.2	1.2	66	
	Woven	Stainless steel	6x6	3.4x3.4	0.9	63	

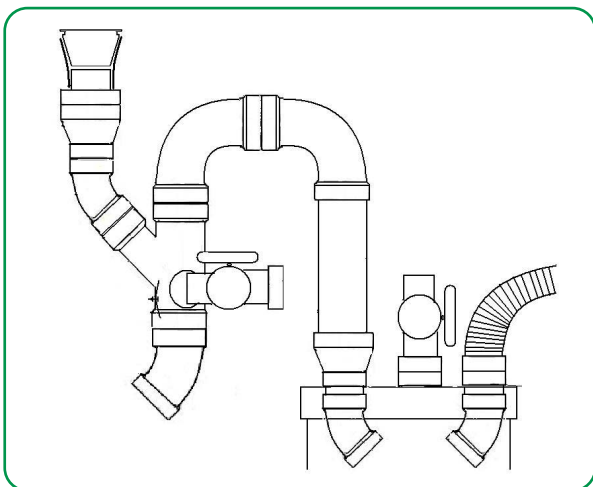


**Figure 61.** Example of cooling tray with fan attached at the bottom ([cocoatown.com](http://cocoatown.com)).

## 14.6 Equipment, tools and materials for breaking and winnowing



**Figure 62.** Semi-manual method of winnowing cacao beans. a) Rolling pin, b) hair dryer (Bioversity International, Archila, 2022).



**Figure 63.** Diagram of a self-made winnower using pipes and accessories is activated using a vacuum cleaner. More detailed information can be found at [chocolatealchemy.com/](http://chocolatealchemy.com/).



**Figure 64.** CAPCO stainless steel equipment for a) breaking and b) winnowing cacao beans ([capco.co.uk](http://capco.co.uk)).

**Table 64.** Equipment specifications and procedure for using CAPCO breaker and winnower (Castlebrook Engineering Ltd, 2020).

<b>CAPCO BREAKER</b>	
<b>Attributes</b>	<b>Specifications</b>
<b>Dimensions LxWxH (cmxcmxcm)</b>	42x47x45
<b>Weight (kg)</b>	36
<b>Capacity (kg/h)</b>	15–20
<b>Electrical power</b>	0.25kW motor available in 220/240V 1 phase 50Hz or with 110V 1 phase 60Hz
<b>Construction materials</b>	Cast iron, stainless steel, brass (inlet hopper and outlet chute from stainless steel, if required)
<b>Procedure for use</b>	<ol style="list-style-type: none"> <li>1. Switch on the power.</li> <li>2. Slowly feed the cacao beans into the inlet hopper that passes into an internal rotating roller.</li> <li>3. Adjust the breaking blocks and rollers to apply just the necessary force needed to shear the beans and avoid unnecessary crushing.</li> <li>4. Collect the broken beans that fall into the collection tray.</li> <li>5. Switch off the power, and unplug the equipment to ensure safety.</li> <li>6. Using a brush and tissue paper, clean the funnel and collection tray between samples. Spin the wheels to ensure complete removal of small bean and pieces of shell. It is recommended to disassemble the front breaker plate and hand brush the teeth of the breaker.</li> </ol>

## CAPCO WINNOWER

Attributes	Specifications
Dimensions LxWxH (cmxcmxcm)	17x37x50/38x64x92
Weight (kg)	8/25
Capacity (kg/h)	5–10/15–20
Electrical power	16W/75W motor available in 220/240V 1 phase 50Hz or with 110V 1 phase 60Hz
Construction materials	Mild steel or fully stainless steel
Procedure for use	<ol style="list-style-type: none"><li>1. Switch on the power.</li><li>2. Slowly feed the broken cacao beans into the winnower.</li><li>3. Drop them on the left-hand side of the square funnel. This allows the beans to pass through the sloped side of the funnel and into the body of the machine, which improves the winnowing efficiency. Use the adjustment knob to get the best separation of shell with minimum nib loss.</li><li>4. It takes ~3min to feed 400g of broken cacao beans into the winnower.</li><li>5. Collect the nibs and shells that fall into separate reception trays.</li><li>6. Winnowing should be carried out in a separate room, as this winnower blows dust out and may pose food safety concerns.</li></ol> <p><i>NOTE: Depending on the result (how much shell remains among the nibs), it is possible to feed the machine slower or faster, depending on better or less optimal separation results. The process can be repeated several times, if necessary.</i></p> <ol style="list-style-type: none"><li>7. Inspect the outgoing nibs for the presence of unremoved shells. Some remaining shells may remain. Therefore, use a pair of tweezers to remove the remaining shells completely. Pay particular attention to shells that remain stuck to the nibs.</li><li>8. Store the nibs until further use.</li></ol>



a)



b)

Figure 65. CocoaTown™ cacao bean crackers a) Manual Cracker; and b) Power Cracker ([cocoatown.com](http://cocoatown.com)).



**Figure 66.** a) CocoaTown™ Basic Winnower and the 1 metering devices (feeders); b) manual metering device is included by default or c) optional motorized metering device ([cocoatown.com](http://cocoatown.com)).

**Table 65.** Equipment specifications for CocoaTown™ bean cracker (manual cracker and power cracker) and winnower as an example (CocoaTown, 2022).

<b>COCOATOWN™ MANUAL CRACKER</b>	
<b>Attributes</b>	<b>Specifications</b>
<b>Dimensions LxWxH (cmxcmxcm)</b>	63.5x43.2x35.6
<b>Weight (kg)</b>	24
<b>Electrical frequency</b>	50Hz, 60Hz
<b>Voltage</b>	110V, 220V
<b>Other features</b>	Cracks 15kg/hour; all stainless steel construction, easy to clean
<b>Procedure for use</b>	<ol style="list-style-type: none"> <li>1. Switch on the power.</li> <li>2. Feed the cacao beans into the funnel of the breaker.</li> <li>3. Collect the broken beans from the discharge point of the breaker and onto a receiving tray.</li> <li>4. Using a brush and tissue paper, clean the equipment starting from the funnel, making sure to spin the roller as small pieces of shells and beans are removed. To clean stuck nibs between the teeth of the breaker rolls, use a spatula and hand rotate the breaker rolls.</li> </ol>

## COCOATOWN™ BASIC WINNOWER

Attributes	Specifications
Dimensions LxWxH (cmxcmxcm)	63.5x46x38
Weight (kg)	21
Electrical frequency	50Hz, 60Hz
Voltage	110V, 220V
Other features	1000W Vacuum, separates 99% shell in single pass, includes manual metering device and can be up-graded to a motorized one
Procedure for use	<ol style="list-style-type: none"><li>1. Switch on the power.</li><li>2. Adjust the feeder setting rate if the unit is equipped with an automatic feeder.</li><li>3. Slowly feed the broken cacao beans into the winnower funnel.</li><li>4. Adjust the vacuum settings as needed to achieve the best separation between shells and nibs.</li><li>5. Collect the nibs falling through the discharge opening. Shells are automatically collected in the bin at the bottom of the air discharge cyclone.</li><li>6. For best separation, repeat the winnowing as needed.</li><li>7. Using a brush and tissue paper, clean the equipment starting from the funnel, making sure to spin the roller as small pieces of shells and beans are removed.</li><li>8. Inspect the outgoing nibs for the presence of unremoved shells. Some remaining shells may remain. Therefore, use a pair of tweezers to remove the remaining shells completely. Pay particular attention to shells that remain stuck to the nibs.</li><li>9. Store the nibs for further use. See Section 12.4.6.</li></ol>



### Specifications

Brand	Air Crazy
Capacity	3.3litres (3.5 quarters)
Popping mechanism	Hot air

Figure 67. Example of hot air popcorn maker as an optional apparatus to loosen shells from the bean ([westbend.com](http://westbend.com)).

## 14.7 Equipment, tools and materials for liquefying and chocolate processing



**Figure 68.** Examples of table top melanger-type grinders of different brands on the market a) [cocoatown.com](http://cocoatown.com); b) [spectramelangers.com](http://spectramelangers.com); c) [melangers.com](http://melangers.com); d) [chocolatemelangeur.com](http://chocolatemelangeur.com).



**Figure 69.** Inside the melanger: a) view of stone grinder assembly inside the empty stone bowl; b) view of the melanger bowl while grinding cacao nibs into cacao mass. ([chocolatemelangeur.com](http://chocolatemelangeur.com); [chocolatealchemy.com](http://chocolatealchemy.com)).



a) Retsch® pestle and mortar mill



b) Capco® triple roll mill



c) Cacao Cucina® ball mill

**Figure 70.** Other equipment to grind cacao nibs into cacao mass a) [retsch.com](https://www.retsch.com); b) [capco.co.uk](https://www.capco.co.uk); c) [memet.com](https://www.memet.com).



a)



b)



c)

**Figure 71.** Example of grinders that can be used for pregrinding cacao nibs: a) coffee electric blade mill grinder; b) blade mill grinder; c) Champion® juicer grinder ([krups.com](https://www.krups.com); [elgiultra.com](https://www.elgiultra.com); [championjuicer.com](https://www.championjuicer.com)).



**a) High precision analogue micrometer**



**b) Standard analogue micrometer**



**c) Electronic digital micrometer**



**d) Micrometer with Vernier and digital display**

**Figure 72.** Examples of micrometers ranging between 0-25mm with 0.001mm resolution. a) [hahn-kolb.de](http://hahn-kolb.de); b) and c) [tesatechnology.com](http://tesatechnology.com); d) [mitutoyo.co.jp](http://mitutoyo.co.jp).

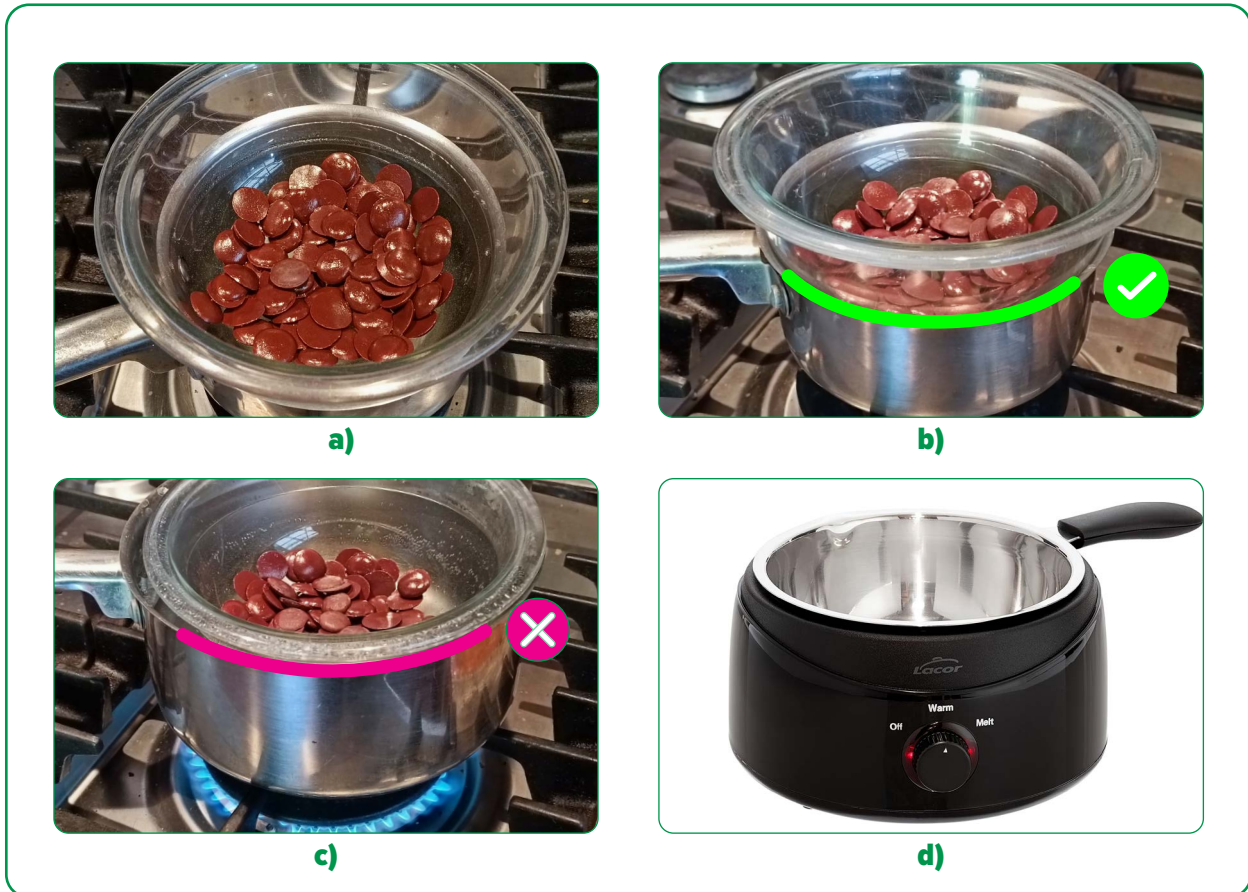


**Figure 73.** Infrared thermometer ([etekcity.com](http://etekcity.com)).



Kathya Archila Bioversity International

## 14.8 Equipment, tools and materials for tempering chocolate



**Figure 74.** Hot water-bath (bain-marie): a) example of proper hot water bath; b) bowl has to fit tightly in the pot without gap in between; c) between the pot and bowl there should be no gap (due to risk of exposure of water steam to chocolate) and stove should be turned off while melting chocolate to prevent burning of chocolate; d) electrical melter with same function (Bioversity International, Alvarado, 2022; [lacor.es](http://lacor.es)).



**Figure 75.** a) Digital vs. b) analog microwave. The timer in analog microwaves is not precise enough to adjust time intervals shorter than a minute and therefore is not adequate for tempering. ([lg.com](http://lg.com)).



**Figure 76.** Tempering on a marble slab ([pixabay.com](https://pixabay.com))



**a)**



**b)**

**Figure 77.** a) Cold water-bath. If the environmental air temperature is too hot, ice can be added to the bath (b) cold water ice can be added (Bioversity International, Alvarado, 2022).



**a)**



**b)**

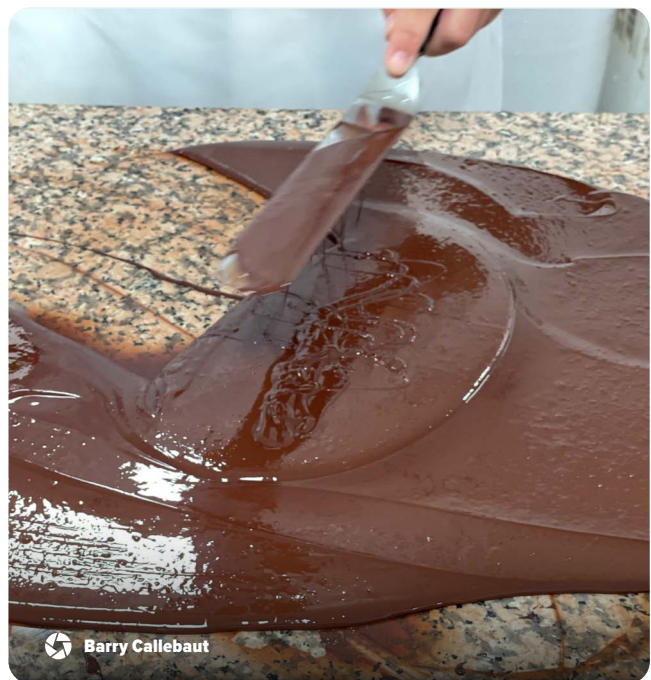


**c)**

**Figure 78.** Examples of digital thermometers: a) infrared thermometer; b) stem thermometer; c) probe thermometer ([etekcity.com](https://etekcity.com); [coleparmer.co.uk](https://coleparmer.co.uk); [hannainst.com](https://hannainst.com)).



**Figure 79.** Spatulas for tempering: a) thermoresistant flexible spatula ([wilton.com](http://wilton.com)); b) scraper spatula ([matferbourgeatusa.com](http://matferbourgeatusa.com)); c) icing spatula ([wilton.com](http://wilton.com)).



**Figure 80.** Heat gun ([bosch-professional.com](http://bosch-professional.com)).



**Figure 81.** Semi automatic tempering machines: a) rotating wheel tempering machine; b) rotating bowl tempering machine. ([perfectchoco.com](http://perfectchoco.com); [chocovision.com](http://chocovision.com)).



**Figure 82.** Fully automatic tempering machine for small quantities ([pomati.it](http://pomati.it)).



**Figure 83.** Example of cacao butter to use in the seeding method ([pixabay.com](http://pixabay.com)).



Barry Callebaut

## 14.9 Equipment tools and materials for the sensory evaluation of unroasted cacao beans



**Figure 84.** Examples of nutcrackers ([foodal.com](http://foodal.com)).



**Figure 85.** Example of electric blade mill grinder. a) Krups F203 coffee grinder viewed from the side and b) from the top ([krupsusa.com](http://krupsusa.com)).



**Figure 86.** Example of a burr grinder. a) GSI outdoors Java Mill portable coffee grinder ready for use and b) its parts ([gsioutdoors.com](http://gsioutdoors.com)).

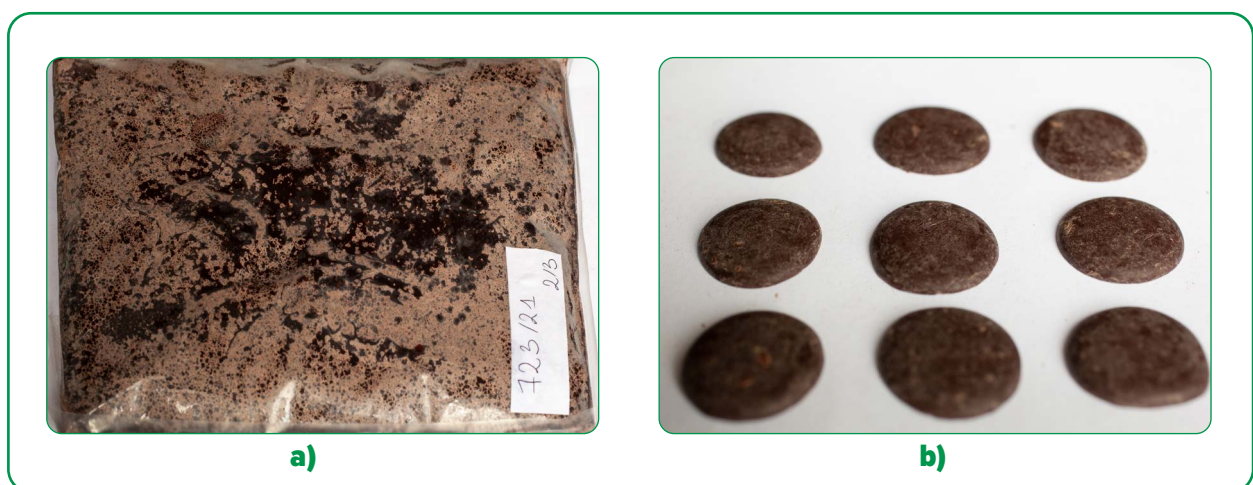


**Figure 87.** Examples of containers of 200–240ml ( $\frac{3}{4}$  – 1 cup) capacity with lid to store for up to 3 hours and hold coarse powder of unroasted cacao beans for sensory evaluation. a) [specialtybottle.com](http://specialtybottle.com); b) [ravennindia.com](http://ravennindia.com); c) [firatmed.com](http://firatmed.com).

### 14.10 Equipment, tools and materials for cacao mass sensory evaluation



**Figure 88.** Appearance of solid cacao mass stored inside diferent airtight containers (Bioversity International, Archila, 2022).



**Figure 89.** a) Appearance of solid cacao mass stored as a bar in vacuum-sealed bag and b) portioned in 1–2g drops (Bioversity International, Archila, 2022).



**Figure 90.** Example of 28ml cups: a) plastic with lid, b) glass with alumina paper lid to hold cacao mass sample. (Bioversity International, Archila, 2022).



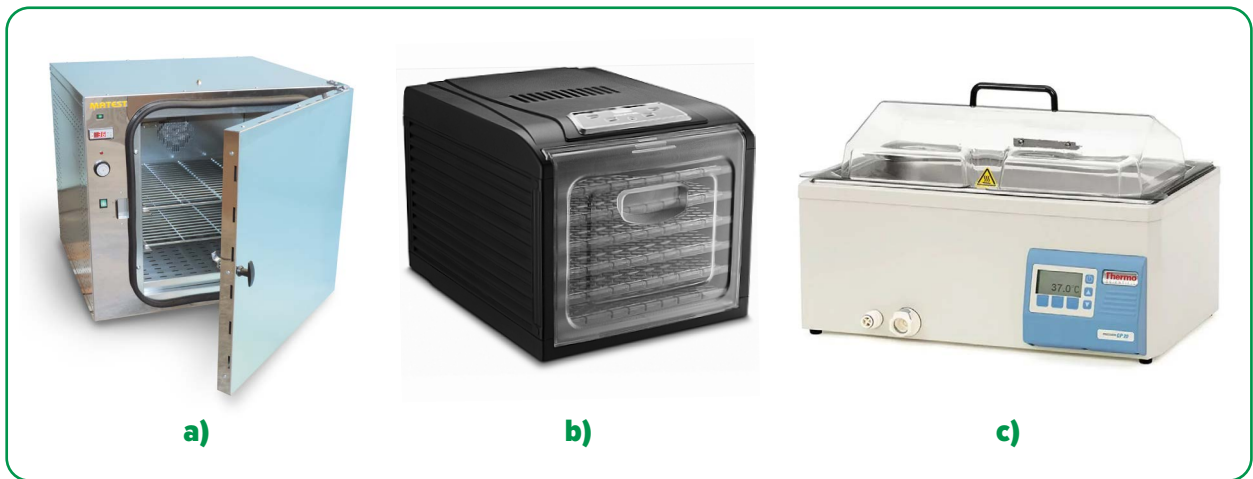
**Figure 91.** Examples of heating equipment for sensory evaluation: laboratory dry block heaters with heated lid; a) normal size and b) smaller size ([ohaus.com](https://www.ohaus.com); [uk.vwr.com](https://www.uk.vwr.com)).



**Figure 92.** Example of heating equipment for cacao mass sensory evaluation: a warming plate ([labotect.com](https://www.labotect.com)).



**Figure 93.** Example of a thermos to keep water warm at 40–50°C for the cacao mass sensory evaluation ([bunn.com](https://www.bunn.com)).



**Figure 94.** Examples of heating equipment for cacao mass sensory evaluation: a) heating oven ([matest.com](http://matest.com)); b) food dehydrator ([gourmia.com](http://gourmia.com)); c) laboratory water bath or bain-marie ([fishersci.es](http://fishersci.es)).



# List of tables

Page

- 24 Table 1.** Key parameters and specifications for all protocols.
- 26 Table 2.** Guidelines for Good Hygienic and Manufacturing Practices for cacao quality and flavour (Bioversity International\Dolores Alvarado, 2022 based on FAO and WHO, 2020).
- 28 Table 3.** Basic principles of the HACCP approach (US FDA, 2017; Velmourougane et al., 2014).
- 31 Table 4.** Optimal temperature and relative humidity for storing cacao products to maintain quality and flavour.
- 33 Table 5.** Key specifications for sampling.
- 36 Table 6.** Guide to sampling bagged cacao beans by lot size (assumption: bag weight of 65kg).
- 39 Table 7.** Minimum sampling points for taking incremental samples from a wagon or vehicle based on the amount of beans contained.
- 42 Table 8.** Example of information to be recorded on a bean lot.
- 46 Table 9.** Key specification for the determination of moisture content.
- 50 Table 10.** Measurement of moisture content by oven-drying method.
- 50 Table 11.** Measurement of moisture content using a moisture metre.
- 51 Table 12.** Key specifications for the physical evaluation of whole cacao beans.
- 53 Table 13.** Classification of beans by size based on bean count/100g (ISO 2451:2017). National regulations may differ.
- 54 Table 14.** Example of grading allowances for cacao beans following a quality assessment (ICE, 2017). National grading systems may vary according to national laws or agreements with client.
- 55 Table 15.** Data to be recorded for sieving, cleaning loss and yields of clean beans.
- 55 Table 16.** Data to be recorded for the bean count and the average bean weight as indicators of bean size.
- 55 Table 17.** Data to be recorded for the appearance and aroma of whole beans.
- 56 Table 18.** Key specifications for the physical evaluation of cut cacao beans.
- 59 Table 19.** Characteristics of internal appearance of beans by groups (based on Sukha, 2016; and Seguine, 2014).
- 61 Table 20.** Form to record the appearance and aroma of cut beans. It is recommended 50 should be described.
- 64 Table 21.** Key specifications for roasting cacao beans.
- 65 Table 22.** Recommended specifications for the roasting oven.
- 68 Table 23.** Basic roasting conditions, including temperature and time, are determined based on the aromas identified in the cut test and the dominant genetic type of the cacao beans (if known).
- 70 Table 24.** Data to be recorded for the roasting process and roasting results.
- 71 Table 25.** Key specifications for breaking and winnowing cacao beans.
- 76 Table 26.** Data to be recorded for breaking and winnowing cacao beans.
- 77 Table 27.** Key specifications for processing cacao nibs into mass.

- 82 Table 28.** Data to be recorded for grinding cacao nibs into mass.
- 83 Table 29.** Key specifications for processing cacao mass into dark chocolate.
- 83 Table 30.** Standard for cacao butter as provided by *Codex Stan 86-1981*.
- 86 Table 31.** Standard recipe used by Cacao of Excellence to process cacao mass into chocolate for the sensory evaluation of cacao beans.
- 91 Table 32.** Data to be recorded for the chocolate-making process.
- 100 Table 33.** Example of sample coding and serving orders for 6 samples evaluated by 6 assessors.
- 100 Table 34.** Example of the final serving order for each assessor with codes.
- 103 Table 35.** Key specifications for the sensory evaluation of cacao beans as unroasted coarse powder.
- 107 Table 36.** Key specifications for the sensory evaluation of cacao beans as cacao mass.
- 115 Table 37.** Key specifications for the sensory evaluation of cacao beans as dark chocolate.
- 120 Table 38.** Cacao of Excellence Glossary of terms for sensory evaluation of cacao beans processed into mass and dark chocolate (Cacao of Excellence 2023).
- 124 Table 39.** Meaning of the global quality scores for the sensory evaluation of cacao beans processed into mass and chocolate (Cacao of Excellence 2023).
- 125 Table 40.** Sensory evaluation form for unroasted cacao beans as coarse powder (Adapted from FCCI).
- 126 Table 41.** Calculations of the total scores for the flavour attributes of the Cacao of Excellence Sensory Evaluation Form.
- 129 Table 42.** Simplified list of flavour attributes for sensory evaluation of cacao beans processed into mass and chocolate (Cacao of Excellence 2023).
- 132 Table 43.** Information to be recorded for cacao sample processing.
- 133 Table 44.** Information to be recorded for a for a sensory evaluation.
- 139 Table 45.** Examples of moisture metres.
- 141 Table 46.** Example of variables for the calculation of the standard deviation.
- 147 Table 47.** Comparison of bean grade according to existing standards (Beckett, 2009, End and Dand, 2015, US FDA, 2017).
- 148 Table 48.** Cacao bean grading standards by country (Dand and Scheu, 1995 published in UNCTAD and WTO, 2001).
- 152 Table 49.** Adjustments in roasting temperature (°C ) and time (minutes) by moisture content (%) and cacao bean size (bean count of 100g or average bean weight) (Cacao of Excellence Technical Committee, 2019).
- 154 Table 50.** Example: Beans with the following characteristics and basic roasting conditions.
- 160 Table 51.** Options for heating and cooling chocolate manually: advantages and disadvantages.
- 161 Table 52.** Troubleshooting for the tempering process.
- 164 Table 53.** Examples of specifications for a sampling spear for bagged and bulk sampling (ISO 2292:2017).

- 164 Table 54.** Examples of specifications for handheld sampling scoops for bulk sampling (Sampling Systems Ltd., 2018).
- 165 Table 55.** Examples of specifications for handheld sampling scoops for bulk sampling (Sampling Systems Ltd., 2018).
- 166 Table 56.** Specifications for Aqua-Boy KAM III moisture metre (Enercorp Instruments Ltd, 2008).
- 166 Table 57.** Specifications for Dickey-John Mini GAC 2500 moisture metre (Dickey-John, 2017).
- 167 Table 58.** Specifications for Wile Coffee and Cocoa moisture metre (Farmcomp Oy, 2011).
- 168 Table 59.** Sieve mesh size comparison chart of screens appropriate for cleaning of cacao beans (Gilson Company Inc., 2018).
- 170 Table 60.** Examples of ovens that comply with the recommended specifications.
- 170 Table 61.** Specifications for the Binder® Oven FD 56 as an example (Binder GmbH, 2017).
- 172 Table 62.** Standard specifications for a square wire mesh that are compliant with the ISCQF standards for constructing mesh-type oven trays (Metals Service Center Institute, 2022).
- 173 Table 63.** Examples of commercial wire mesh that can be used for constructing oven trays.
- 175 Table 64.** Equipment specifications and procedure for using CAPCO breaker and winnower (Castlebroom Engineering Ltd, 2020).
- 177 Table 65.** Equipment specifications for CocoaTown™ bean cracker (manual cracker and power cracker) and winnower as an example (CocoaTown, 2022).

# List of figures

Page

- 21 Figure 1.** Elements of quality and flavour assessment included in this Guide.
- 30 Figure 2.** Proper hand washing and sanitising techniques (WHO, 2006).
- 34 Figure 3.** Schematic representation of the sampling process and types of samples (based on: ISO, 2292:2017 and ISO, 2451:2017).
- 35 Figure 4.** Decision-tree to determine the minimum number of reference samples (t=tonne).
- 36 Figure 5.** Sample collection using a spear from an undamaged bag.
- 38 Figure 6.** Chart illustrating the splitting of a 2kg reference sample into preliminary test samples for all evaluations described in this guide (based on ISO 2451:2017).
- 39 Figure 7.** Example of a calculation of sampling intervals for a lot in motion (Bioversity International, 2022).
- 49 Figure 8.** Comparison between oven-drying and moisture meter methods.
- 66 Figure 9.** The open area of a screen ( $A_o$ ) defines the mesh openings as a percentage of the entire screen surface and is based on the ratio between mesh width ( $w$ ), assuming the space is square, and the wire diameter ( $d$ ). (metalmesh.com.au/glossary)
- 75 Figure 10.** Formula for calculating the yield of cacao nibs from roasted beans.
- 81 Figure 11.** Producing cacao mass drops in portion size: a) piped drops on the parchment paper b) detaching drops after solidifying (Bioversity International, Alvarado, 2019).
- 95 Figure 12.** Example of a sensory evaluation facility: Layout of the Cacao of Excellence laboratory in Rome, Italy.
- 96 Figure 13.** Example of layout for sample preparation similar to a kitchen environment.
- 97 Figure 14.** (Top) Sensory areas equipped with tables and movable partitions constructed from non-resinous wood or plywood painted with neutral colours. (Bottom) Example of a construction layout for portable sensory booths. (Alejandro Anzueto/Universidad del Valle de Guatemala; <https://thelabinthebag.com> and Lawless and Heymann, 2010).
- 98 Figure 15.** a) Fixed sensory evaluation booths that are individualised and limit interactions between assessors; b) Sample layout for a single, fixed sensory evaluation booth. (Alejandro Anzueto/Universidad del Valle de Guatemala and ISO 8589:2007).
- 102 Figure 16.** Table of random numbers: start on any column or row and read in any direction to create random three-digit numbers to label the sample cups. (Lawless and Heymann, 2010).
- 110 Figure 17.** a) Sensory evaluation booth equipped with samples, printed evaluation form, spatula and water thermos b) with heating equipment; and ; and c) with heating equipment and computer with evaluation form (Bioversity International, Archila, 2022).
- 112 Figure 18.** Example of steps for staggering the melting of samples.
- 112 Figure 19.** Example of heating stages of cacao mass samples when serving to a panel (using a food dehydrator). (Dolores Alvarado/ Bioversity International).
- 119 Figure 20.** Cacao of Excellence Flavour Wheel (2023).
- 127 Figure 21.** User interface of the Excel version of the Cacao of Excellence Sensory Evaluation Form with the total scores of flavour attributes calculated (Cacao of Excellence 2023).

- 128 Figure 22.** Format for the printed version of the Excel version of the Cacao of Excellence Sensory Evaluation Form (Cacao of Excellence 2023).
- 130 Figure 23.** Example of a line graph for a cacao mass flavour profile (Bioversity International, 2018).
- 130 Figure 24.** Example of a bar graph for a cacao mass flavour profile (Bioversity International, 2018).
- 131 Figure 25.** Example of a spider/radar graph for a cacao mass flavour profile (Bioversity International, 2018).
- 131 Figure 26.** Example of the Cacao of Excellence flavour profile plot.
- 136 Figure 27.** Steps for a randomised selection of specific bags in a lot.
- 137 Figure 28.** Diagram of quartering process (Harvey, 2013).
- 137 Figure 29.** Preparation of reference samples using a quartering tool (MS, 230:2007).
- 138 Figure 30.** Sample calculation of moisture content.
- 142 Figure 31.** Categories of cleaning loss in cacao beans: a) foreign matter b) placenta; c) flat beans; d) bean clusters; e) broken or cut beans; f) shell and bean fragments; and g) infested beans (Bioversity International, Archila, 2022).
- 143 Figure 32.** Typical colour of cacao beans with increasing degree of fermentation (from left to right) (Bioversity International, Archila, 2022).
- 144 Figure 33.** Examples of cut cacao beans at different stages of fermentation (Sukha and Rohsius, 2004).
- 145 Figure 34.** Increasing degree of cacao bean fissuring from top left to bottom right (Bioversity International, Archila, 2022).
- 146 Figure 35.** Colour reference tool for photographs of beans. a) MacBeth ColorChecker (Kresliln et al, 2014); b) Tiffen Color Control Patches similar exist from other brands like Kodak, Fuji Film and others; and c) use of adapted colour reference tool for cut test picture (Bioversity International, Alvarado, 2018).
- 154 Figure 36.** Table reading of roasting time and temperature adjustments for cacao beans at 7.8% moisture and a count of 60 beans/100g.
- 155 Figure 37.** Main parts of a standard Vernier micrometer.
- 156 Figure 38.** Cacao mass preparation procedure using mineral oil, for measuring particle size with a micrometer (Bioversity International, Archila, 2022).
- 157 Figure 39.** Reading analogue micrometers with 0.001mm resolution. \Standard Vernier micrometer ([www.stefanelli.eng.br/es](http://www.stefanelli.eng.br/es)).
- 157 Figure 40.** Reading analogue micrometers with 0.001mm resolution: high-precision Vernier micrometer (Seguine, 2014).
- 159 Figure 41.** Ingredient calculation examples with total desired amount of chocolate as the basis.
- 159 Figure 42.** Ingredient calculation examples with cacao mass as the basis.
- 162 Figure 43.** Examples of spears for sampling beans in bags (a, b and c) and for sampling of bulk beans (d). (ISO, 2292:2017).
- 162 Figure 44.** Examples of sampling scoops for bulk sampling.

- 163 Figure 45.** Examples of weighing scales with at least 2kg capacity: a) analog and b) digital. ([www.soehnle-professional.com/en](http://www.soehnle-professional.com/en); [www.mt.com](http://www.mt.com)).
- 163 Figure 46.** Example of (a) stainless steel and (b) plastic storage vessels for preparing the composite sample from primary or incremental samples. Storage containers must be equipped with lids to minimise moisture loss/gain, foreign odour/off-odour absorption, and insect and/or rodent infestation. ([www.sampling.com](http://www.sampling.com); [www.mannlakeltd.com](http://www.mannlakeltd.com)).
- 164 Figure 47.** Interior of a quartering tool showing the quartering irons (MS, 230:2007).
- 165 Figure 48.** a) oven, b) desiccator; and c) metal dishes, for meaning moisture content using the oven-drying method ([matest.com](http://matest.com); [coleparmer.co.uk](http://coleparmer.co.uk); [certifiedmtp.com](http://certifiedmtp.com)).
- 166 Figure 49.** a) Cacao-specific moisture metre Aqua-Boy KAM III with cup electrode 202 and b) stab electrode 209 b, cable and holder. ([aqua-boy.co.uk](http://aqua-boy.co.uk)).
- 167 Figure 50.** Dickey-John Mini GAC 2500 moisture metre with loader ([dickey-john.com](http://dickey-john.com)).
- 167 Figure 51.** Wile Coffee and Cocoa moisture metre ([wile.fi](http://wile.fi)).
- 167 Figure 52.** Example of an electronic top-loading scale for weighing the samples ([www.soehnle-professional.com/en](http://www.soehnle-professional.com/en)).
- 168 Figure 53.** a) Test sieve for separating cacao beans from dirt particles; b) mechanical sieve shaker for bean size distribution measurement and analysis ([lavallab.com](http://lavallab.com)).
- 169 Figure 54.** Example of cutting beans individually with a knife (Bioversity International, Archila, 2022).
- 169 Figure 55.** Examples of classification boards for cut beans (Neuhaus, 2006; Neuhaus, 2007).
- 169 Figure 56.** Example of bean cutting procedure using a Magra 14 guillotine cutter from Tesserba ([tesserba.ch](http://tesserba.ch)).
- 170 Figure 57.** a) Image of Binder® Oven FD 56 closed and b) open. Notice the symmetrical position of the trays above and below the fan opening ([binder-world.com](http://binder-world.com)).
- 171 Figure 58.** a) Original Binder® oven tray; b) same tray screen covered; c) detail of screen frame corner; d) back of adapted tray. Notice the edge lips that allow the entire tray to be used for roasting but not risk any beans falling off (Seguine, 2014).
- 171 Figure 59.** Other stainless steel wire roasting trays adapted to suit the area of the oven tray (a) Sukha and Ali, 2016; b) Bioversity International, Archila, 2022.
- 172 Figure 60.** Differences in screen open area are defined by two parameters: mesh size and wire diameter. ([metalmesh.com.au/glossary/](http://metalmesh.com.au/glossary/)).
- 174 Figure 61.** Example of cooling tray with fan attached at the bottom ([cocoatown.com](http://cocoatown.com)).
- 174 Figure 62.** Semi-manual method of winnowing cacao beans. a) Rolling pin, b) hair dryer (Bioversity International, Archila, 2022).
- 174 Figure 63.** Diagram of a self-made winnower using pipes and accessories is activated using a vacuum cleaner. More detailed information can be found at [chocolatealchemy.com/](http://chocolatealchemy.com/).
- 175 Figure 64.** CAPCO stainless steel equipment for a) breaking and b) winnowing cacao beans ([capco.co.uk](http://capco.co.uk)).
- 176 Figure 65.** CocoaTown™ cacao bean crackers a) Manual Cracker; and b) Power Cracker ([cocoatown.com](http://cocoatown.com)).

- 177 **Figure 66.** a) CocoaTown™ Basic Winnower and the 1 metering devices (feeders); b) manual metering device is included by default or c) optional motorized metering device (cocoatown.com).
- 178 **Figure 67.** Example of hot air popcorn maker as an optional apparatus to loosen shells from the bean (westbend.com).
- 179 **Figure 68.** Examples of table top melanger-type grinders of different brands on the market a) cocoatown.com; b) spectramelangers.com; c) melangers.com; d) chocolatemelangeur.com.
- 179 **Figure 69.** Inside the melanger: a) view of stone grinder assembly inside the empty stone bowl; b) view of the melanger bowl while grinding cacao nibs into mass. (chocolatemelangeur.com; chocolatealchemy.com).
- 180 **Figure 70.** Other equipment to grind cacao nibs into cacao mass a) retsch.com; b) capco.co.uk; c) memet.com.
- 180 **Figure 71.** Example of grinders that can be used for pregrinding cacao nibs: a) coffee electric blade mill grinder; b) blade mill grinder; c) Champion® juicer grinder (krups.com; <https://www.elgiultra.com>; championjuicer.com).
- 181 **Figure 72.** Examples of micrometers ranging between 0-25mm with 0.001mm resolution. a) hahn-kolb.de; b) and c) tesatechnology.com; d) mitutoyo.co.jp.
- 181 **Figure 73.** Infrared thermometer (etekcity.com).
- 182 **Figure 74.** Hot water-bath (bain-marie): a) example of proper hot water bath; b) bowl has to fit tightly in the pot without gap in between; c) between the pot and bowl there should be no gap (due to risk of exposure of water steam to chocolate) and stove should be turned off while melting chocolate to prevent burning of chocolate; d) electrical melter with same function (Bioversity International, Alvarado, 2022; lacor.es).
- 182 **Figure 75.** a) Digital vs. b) analog microwave. The timer in analog microwaves is not precise enough to adjust time intervals shorter than a minute and therefore is not adequate for tempering. (lg.com).
- 183 **Figure 76.** Tempering on a marble slab (pixabay.com)
- 183 **Figure 77.** a) Cold water-bath. If the environmental air temperature is too hot, ice can be added to the bath (b) cold water ice can be added (Bioversity International, Alvarado, 2022).
- 183 **Figure 78.** Examples of digital thermometers: a) infrared thermometer; b) stem thermometer; c) probe thermometer (etekcity.com; coleparmer.co.uk; hannainst.com).
- 184 **Figure 79.** Spatulas for tempering: a) thermoresistant flexible spatula (wilton.com); b) scraper spatula (matferbourgeatusa.com); c) icing spatula (wilton.com).
- 184 **Figure 80.** Heat gun (bosch-professional.com).
- 185 **Figure 81.** Semi automatic tempering machines: a) rotating wheel tempering machine; b) rotating bowl tempering machine. (perfectchoco.com; chocovision.com).
- 185 **Figure 82.** Fully automatic tempering machine for small quantities (pomati.it).
- 185 **Figure 83.** Example of cacao butter to use in the seeding method (pixabay.com).
- 186 **Figure 84** Examples of nutcrackers (foodal.com).
- 186 **Figure 85.** Example of electric blade mill grinder. a) Krups F203 coffee grinder viewed from the side and b) from the top (krupsusa.com).

- 186 Figure 86.** Example of a burr grinder. a) GSI outdoors Java Mill portable coffee grinder ready for use and b) its parts ([gsioutdoors.com](http://gsioutdoors.com)).
- 187 Figure 87.** Examples of containers of 200–240ml ( $\frac{3}{4}$  –1 cup) capacity with lid to store for up to 3 hours and hold coarse powder of unroasted cacao beans for sensory evaluation. a) [specialtybottle.com](http://specialtybottle.com); b) [ravennindia.com](http://ravennindia.com); c) [firatmed.com](http://firatmed.com).
- 187 Figure 88.** Appearance of solid cacao mass stored inside diferent airtight containers (Bioversity International, Archila, 2022).
- 187 Figure 89.** a) Appearance of solid cacao mass stored as a bar in vacuum-sealed bag and b) portioned in 1–2g drops (Bioversity International, Archila, 2022).
- 188 Figure 90.** Example of 28ml cups: a) plastic with lid, b) glass with alumina paper lid to hold cacao mass sample. (Bioversity International, Archila, 2022).
- 188 Figure 91.** Examples of heating equipment for sensory evaluation: laboratory dry block heaters with heated lid; a) normal size and b) smaller size ([ohaus.com](http://ohaus.com); [uk.vwr.com](http://uk.vwr.com)).
- 188 Figure 92.** Example of heating equipment for cacao mass sensory evaluation: a warming plate ([labotect.com](http://labotect.com)).
- 188 Figure 93.** Example of a thermos to keep water warm at 40–50°C for the cacao mass sensory evaluation ([bunn.com](http://bunn.com)).
- 189 Figure 94.** Examples of heating equipment for cacao mass sensory evaluation: a) heating oven ([matest.com](http://matest.com)); b) food dehydrator ([gourmia.com](http://gourmia.com)); c) laboratory water bath or bain-marie ([fishersci.es](http://fishersci.es)).

# Contributors

## COORDINATORS AND CONTRIBUTORS

**Brigitte Laliberté** (Cacao of Excellence/Alliance of Bioversity International and CIAT)

**Dolores Alvarado** (Cacao of Excellence/Alliance of Bioversity International and CIAT)

## MAIN CONTRIBUTORS

**Ed Seguire** (Cacao Cocoa and Chocolate Advisors/Guittard Chocolate)

**Darin Sukha** (CRC/UWI)

## ISCQF WORKING GROUP MEMBERS (AFFILIATIONS AT THE TIME OF PUBLICATION OF DRAFTS)

**Bill Guyton** (FCIA)

**Brad Kintzer** (TCHO)

**Brigitte Laliberté** (Cacao of Excellence/Alliance of Bioversity International and CIAT)

**Carla Martin** (FCCI)

**Carolina Aguilar** (LWR)

**Charlotte Martin** (ICCO)

**Cristina Liberati** (EE/CDP)

**Dan Domingo** (ECOM Trading)

**Daphne Braak** (CBI)

**Darin Sukha** (CRC/UWI).

**Ed Seguire** (Seguire Cacao Cocoa and Chocolate Advisors/Guittard Chocolate)

**Erik Plaisier** (CBI)

**Herve Biseleua** (WCF)

**John Kehoe** (Guittard Chocolate)

**Juan Francisco Mollinedo** (AMACACAO)

**Julien Simonis** (Belcolade/Puratos)

**Martin Christy** (IICCT)

**Mey Choy Paz** (CDP/FCIA) (EE/CDP)

**Nene Akwetey-Kodjoe** (WCF)

**Nubia Martínez** (UNALM)

**Pierre Costet** (Valrhona Chocolate)

**Renata Januszewska** (Barry Callebaut)

**Rick Peyser** (LWR)

CONTRIBUTORS (NOT WORKING GROUP MEMBERS) PRIOR TO FIRST PUBLIC DRAFT PUBLICATION - VIA MEETINGS, TASK FORCES, EXPERT CONSULTATIONS, AND/OR SHORT REVIEWS

**Coralie Veyrac** (Barry Callebaut)

**José López Ganem** (FCCI)

**Philip Sigley** (FCC)

**Robin Dand** (Robin Dand Commodities Ltd)

**Siela Maximova** (Penn State University)

DRAFTING TEAM MEMBERS – CACAO OF EXCELLENCE/ALLIANCE OF BIOVERSITY INTERNATIONAL AND CIAT BETWEEN 2018-2019

**Arisa Thamsuaidee**

**Chinkee Lim**

**Jami Willard**

**Patricia Cuba**

**Pramitha Pothan**

**Sue González**

MEMBERS PART OF THE CACAO OF EXCELLENCE TECHNICAL COMMITTEE AT THE TIME OF THE DRAFTING AND REVIEW

**Ed Seguire** Chair (Cacao Cocoa and Chocolate Advisors/Guittard Chocolate)

**Adriana Arciniégas** (Centro Agronómico Tropical de Investigación y Enseñanza (CATIE))

**Brad Kintzer** (TCHO)

**Darin Sukha** (CRC/UWI)

**Dorine Kassi** (QHSE)

**Fabien Coutel** (Treegether)

**Florent Coste** (Valrhona)

**John Kehoe** (Guittard Chocolate)

**Julien Simonis** (Puratos)

**Karin Chatelain** (ZHAW)

**Naailah Ali** (CRC/UWI)

**Nubia Martínez** (National Agrarian University at La Molina in Lima)

**Régis Bouet** (Régis Bouet Solutions (RBS))

**Stephen Yaw Opoku** (Cocoa Research Institute of Ghana (CRIG))

REVIEWERS (PUBLIC REVISION)

COUNTRY	ORGANIZATION	NAME
<b>Brazil</b>	Independent	Albertus Eskes
<b>Colombia</b>	InSitu Universidad Nacional Abierta y a Distancia	Carlos Torres Lucas Quintana
<b>Côte d'Ivoire</b>	CEMOI International Cocoa Organization (ICCO)	Mahieu Aka Charlotte Martin
<b>Dominican Republic</b>	Cacao Forest / Zorzal Cacao Chocolates Khao Caribe, SRL CONACADO  COOPCANOR Cortés Hermanos Definite Chocolate, SRL DR Cocoa Foundation Exporting Quality Program / International Executive Service Corps  Laboratorio del Cacao, Ministerio de Agricultura  Recursos Globales, SRL Rizek Valdez Cacao SFM, SRL Xocolat	Heriberto Paredes Moisés Davidovits Cosme Gilberto Guerrero Elizabeth Burgos Yenny Medina  Pedro Ramón Reyes Pena Bienvenido Then Jens Kamin Yirelisa Alcántara Ana Tolentino Peggy Aviotti  Mariolis Castaño Tejada Nikaurys Genaro Frías  José Alejandro Elaine de Windt F. José Valdéz Diana Munne
<b>Ecuador</b>	Agencia de Regulación y Control Fito y Zoon sanitario (AGROCALIDAD)  Asociación Nacional de Exportadores de Cacao del Ecuador (ANECACAO)  Conexión Chocolate	Yessenia Echeverría  Cristian Noboa  Luisa Mafla Mario Remache

COUNTRY	ORGANIZATION	NAME
Ecuador	ECOM	Maria Merchán
	Escuela Politécnica Nacional	Carolina Ramos Yadira Quimbita
	Escuela Superior Politécnica de Manabí	Paúl Cedeño
	Guangala	Jaime Zea
	Instituto Nacional de Investigaciones Agropecuarias del Ecuador (INIAP)	Gladys Rodríguez
	Jand Cacao	Wilman Quezada
	Ministerio de Agricultura y Ganadería	Andrés Proaño Gabriela Chacón Luis Herrera
		Individual names not provided
	Nestlé	Alejandra Rivadeneira Angie Largo
	Organization name not provided	Bethsy Hurtado Brissia Millones Edgar Zambrano Elsa Zárate Flavio Legards Franklin Tipán José Barén José García Juan Arévalo Ludy Rivas Miguel Pérez Pablo Conselmo Wilman Quezada
	Rikolto International	José Luis Cueva
	Servicio Ecuatoriano de Normalización (INEN)	Jessie Gallardo
	Unión de Organizaciones Campesinas Cacaoteras	Lady Paredes
	Universidad Técnica Estatal de Quevedo	Wiston Morales
Organization name not provided	Pedro López	
France	CEMOI	Julien Menou Sabine Quintana
	Valrhona	Pierre Costet
Germany	SGS	Lisa Marie Klttelmann

COUNTRY	ORGANIZATION	NAME
<b>Haiti</b>	Haiti National Organization Committee	Individual names not provided
<b>Indonesia</b>	Indonesian Coffee and Cocoa Research Institute	Ariza Budi Tunjung Sari
<b>Malaysia</b>	Malaysian Cocoa Board	Dr. Khairul Bariah Sulaiman Mohamed Yusof bin Ishak Suzannah Sharif
<b>Netherlands</b>	OLAM Cocoa	Marjon Theunissen
<b>Nicaragua</b>	APAC–Comisión de Cacao	Individual names not provided
	APEN–Comisión de Cacao	Individual names not provided
	Castillo del Cacao–Comisión de Cacao	Individual names not provided
	Clayo Chocolates–Comisión de Cacao	Individual names not provided
	Cooperativa La Campesina–Comisión de Cacao	Individual names not provided
	EXPASA–Comisión de Cacao	Individual names not provided
	Madre Cacao–Comisión de Cacao	Individual names not provided
	Ritter Sport–Comisión de Cacao	Individual names not provided
	Semillas Group–Comisión de Cacao	Individual names not provided
<b>Papua New Guinea</b>	Independent	Grant Vinning

<b>COUNTRY</b>	<b>ORGANIZATION</b>	<b>NAME</b>
<b>Peru</b>	Comité Técnico Nacional de Cacao y Chocolate (INACAL)	Individual names not provided
<b>Philippines</b>	DA Bureau of Standards	Krishna Mecija
<b>Switzerland</b>	ZHAW	Karin Chatelain
<b>Trinidad and Tobago</b>	Cacao Development Company Trinidad and Tobago Limited	Fayaz Shah Matthew Escalante Roger Poliah Siddiqa Ragbirsingh Stefan Lee Son
<b>United Kingdom</b>	Federation of Cocoa Commerce	Phil Sigley Robin Dand
<b>United States</b>	Calkins + Burke Ltd.	Jan Calkins
	Cocoterra	Nate Staal
	Theo Chocolate	Robert Francis

# References

- Adhikari J; Chambers E. & Koppel K. 2019. Impact of Consumption Temperature on Sensory Properties of Hot Brewed Coffee. *Food and Research International* 115:95-104. doi:10.1016/j.foodres.2018.08.014
- Afoakwa EO. 2010. *Chocolate Science and Technology*. Wiley-Blackwell Publishing, Singapore, The Republic of Singapore. 275 p.
- AgraTronix. 2022. Moisture Testers. <https://www.agratronix.com> (Accessed on 3 May 2022).
- Aprotosoai AC; Luca SV & Miron A. 2015. Flavor Chemistry of Cocoa and Cocoa Products – An Overview. *Comprehensive Reviews in Food Science and Food Safety*, 15(1): 73-91. doi:10.1111/1541-4337.12180
- ASEAN (Association of Southeast Asian Nations). 2014. ASEAN Stan 34:2014 Standard for Cocoa Bean. ASEAN Trade Repository. <https://www.asean.org/wp-content/uploads/images/Community/AEC/AMAF/OtherDocuments/ASEAN%20Standard%20for%20Cocoa%20Bean.pdf> (Accessed on 23 July 2018).
- Beckett ST. 2008. *The Science of Chocolate* (2 ed.). The Royal Society of Chemistry, London, United Kingdom. 240 p.
- Beckett ST. (eds.). 2009. *Industrial Chocolate Manufacture and Use* (4 ed.). Blackwell Publishing Ltd, West Sussex, United Kingdom. 668 p.
- Beckett ST; Yates, P. 2009. Formulation. In: Talbot G. (ed.), *Technology of Coated and Filled Chocolate, Confectionery, and Bakery Products*. Woodhead Publishing Limited, Cambridge, United Kingdom. pp. 11-52.
- Binder GmbH. 2017. Binder FD 56 Operating Manual. <https://www.binder-world.com> (Accessed on 2 May 2022).
- Binder GmbH. 2019. Binder 9010-0255 FP Programmable Mechanical Convection Oven; 4.1 cu ft, RS-422, 230V. <https://www.binder-world.com> (Accessed on 2 May 2022).
- Bottles & Jars. 2022. Bottles & Jars. <https://www.specialtybottle.com/> (Accessed 10 June 2022).
- Bray J. 2012. The Golden Cacao Cut. On the Cocoa Trail. <https://onthecocoatrail.com/2012/06/27/the-golden-cut/> (Accessed on 24 July 2018).
- BSI (British Standard Institution). 1992. BS 5098:1992. Terms Relating to Sensory Analysis. London, United Kingdom. 28 p.
- Bunn-O-Matic Corporation. 2022. BUNN 2.5 Liter Lever-Action Airpot, Stainless Steel. <https://www.bunn.com/> (Accessed on 3 May 2022).
- CABI (Centre for Agriculture and Bioscience International). 2016. "CocoaSafe": Capacity Building and Knowledge Sharing in SPS in Cocoa in Southeast Asia. Final Report of Project "CocoaSafe". <https://www.icco.org/wp-content/uploads/2.-CocoaSafe-Capacity-Building-and-Knowledge-Sharing-in-SPS-and-Food-Safety-in-Cocoa-in-South-East-Asia.pdf> (Accessed on 3 May 2022).
- Cacao Móvil. 2021. Aprendiendo e innovando sobre el cacao en sistemas agroforestales. <https://cacaomovil.com/> (Retrieved 9 June 2022).
- Cacao Cucina. 2022. Cacao Cucina Line of Equipment. <http://cacaocucina.com> (Accessed on 2 May 2022).
- Campus-Gemüse. 2022. Sensorik. <http://www.campus-gemuese.de> (Accessed on 1 May 2022).
- Carr BT; Civille GV & Meilgaard MC. 2016. *Sensory Evaluation Techniques* (5 eds.). CRC Press, Boca Raton, USA. 632 p.

Castlebroom Engineering Ltd. 2020. Capco Test Equipment. <https://capco.co.uk> (Accessed on 2 May 2022).

Castlebroom Engineering Ltd. 2022. Triple Roll Mill Stainless Rolls. <https://capco.co.uk> (Accessed on 2 May 2022).

CCC (Le Conseil du Café – Cacao). 2015. Normes D'Exportation du Cacao. [http://www.conseilcafecacao.ci/index.php?option=com\\_content&view=article&id=109&Itemid=180](http://www.conseilcafecacao.ci/index.php?option=com_content&view=article&id=109&Itemid=180) (Accessed on 26 February 2019).

CCUR (Iowa State University Center for Crops Utilization Research). 2022. Facilities Kitchen., <http://www.ccur.iastate.edu> (Accessed on 26 April 2022).

CEN (European Committee for Standardization). 2002. European Standard EN 12464-1: Light and lighting – Lighting of work places – Part 1: Indoor work places. Brussels, Belgium. [http://www.ageta.lt/app/webroot/files/uploads/filemanager/File/info/EN\\_12464-1.pdf](http://www.ageta.lt/app/webroot/files/uploads/filemanager/File/info/EN_12464-1.pdf) (Accessed on 4 July 2019).

Center for Sensory Analysis and Consumer Behaviour. 2015. Evaluation/Focus Group Rooms/ Preparation Space. [www.sensoryanalysis.com](http://www.sensoryanalysis.com): <https://www.sensoryanalysis.com> (Accessed on 1 May 2022).

CFIA (Canadian Food Inspection Agency) – Grains and Oilseeds Section, CSI (Canadian Seed Institute), CGC (Canadian Grain Commission). 2015. Sampling Methods and Procedures Guide, 3rd Version. <https://www.grainscanada.gc.ca/pva-vpa/container-contenant/proc-301/proc3-0-1-en.pdf> (Accessed on 18 July 2018).

Charm School Chocolate. 2022. Chocolate: From Bean to Bar. <https://www.charmschoolchocolate.com> (Accessed on 2 May 2022).

Chatt EM. 1953. Cocoa: Cultivation, Processing, Analysis. In: Kertesz ZI. (ed.), Economic Crops, Vol. III. Interscience Publishers, New York, USA. 1-302 p.

Chocolate Alchemy. 2011. Chocolate Alchemy's DIY Winnower. <http://chocolatealchemy.com> (Accessed on 2 May 2022).

Chocolate Alchemy. 2022. How to Make Chocolate. <https://chocolatealchemy.com> (Accessed on 2 May 2022).

Chocolate Melangeur. 2022. Ultra Perfect Plus Nut Butter Grider. <https://www.chocolatemelangeur.com> (Accessed on 2 May 2022).

Cioccia E. 2011. Bavette Gastronomica. <https://www.bavette.es/> (Accessed on 10 June 2022).

CocoaTown. 2022. CocoaTown Equipment. <https://cocoatown.com> (Accessed on 2 May 2022).

CocoTerra Company. 2022. CocoTerra Tabletop Chocolate Maker. <https://www.cocoterra.com/> (Accessed on 10 June 2022).

Cacao of Excellence Programme. 2019. Technical Procedures for Processing the Cocoa Bean Samples from Participating Countries – from Reception, Physical Quality and Processing into Mass and Chocolate for Flavour Sensory Evaluation. [www.cocoaofexcellence.org](http://www.cocoaofexcellence.org) (Accessed on 2 May 2022).

Coffee Laboratory LLC. 2022. Deluxe Sample Divider Boerner Type. <http://www.coffeelabequipment.com> (Accessed on 2 May 2022).

Cole-Palmer Instruments Company LLC. 2022. Process Equipment for Life Sciences. <https://www.coleparmer.co.uk> (Accessed on 3 May 2022).

- Dand R. 2011. Quality Assessment of Cocoa Beans for International Trade. In: Dand R. (ed.), *The International Cocoa Trade*, (3 ed.). Woodhead Publishing Limited, Sawston, United Kingdom. 219-267 p.
- Dandelion Chocolate. 2017. Education Station: What's up with Whole Roasted Beans? <https://www.dandelionchocolate.com> (Accessed on 2 May 2022).
- De Zaan. 2006. *The De Zaan Cocoa Manual*. ADM Cocoa BV, Koog aan de Zaan, The Netherlands. 151 p.
- Diamond Custom Machine. 2018. Premier Chocolate Refiners. <https://www.melangers.com> (Accessed on 2 May 2022).
- Dickey-John. 2017. Product Spotlight. <http://www.dickey-john.com> (Accessed on 15 January 2019).
- Edward J. Darby & Son Inc. 2020. Edward J. Darby & Son Cayalog. <https://catalog.darbywiremesh.com> (Accessed on 2 May 2022).
- End MJ; Dand R (eds). 2015. *Cocoa Beans: Chocolate and Cocoa Industry Quality Requirements*. ECA-Caobisco-FCC Joint Cocoa Research Fund [https://www.cocoaquality.eu/data/Cocoa%20Beans%20Industry%20Quality%20Requirements%20Apr%202016\\_En.pdf](https://www.cocoaquality.eu/data/Cocoa%20Beans%20Industry%20Quality%20Requirements%20Apr%202016_En.pdf) (Accessed on 2 May 2022).
- Etekcitec Corporation. 2021. Tools. <https://www.eteckcity.com/> (Accessed on 10 June 2022).
- Faerch. 2015. CPET Takes Foods Directly from the Freezer to Oven. <https://www.faerch.com> (Accessed on 21 November 2019).
- FAO (Food and Agriculture Organization) & WHO (World Health Organization). 1999. *Codex Alimentarius*. Report of the Twenty-Third Session of the Codex Committee on Fish and Fishery Products. CX 5/15. Food and Agriculture Organization, Rome, Italy. <https://www.fao.org/3/W9253E/w9253e0k.htm#bm20.2.2> (Accessed on 18 July 2018).
- FAO (Food and Agriculture Organization) & WHO (World Health Organization). 2004. *Codex Alimentarius*. General Guidelines on Sampling. CAC/GL 50-2004. Food and Agriculture Organization, Rome, Italy. [https://www.fao.org/uploads/media/Codex\\_2004\\_sampling\\_CAC\\_GL\\_50.pdf](https://www.fao.org/uploads/media/Codex_2004_sampling_CAC_GL_50.pdf) (Accessed on 18 July 2018).
- FAO (Food and Agriculture Organization) & WHO (World Health Organization). 2016a. *Codex Alimentarius*. Standard for Cocoa (Cacao) Mass (Cocoa/Chocolate Mass) and Cocoa Cake Codex Stan 141-1983. Food and Agriculture Organization, Rome, Italy. <http://files.eacce.org.ma/pj/1415770249.pdf> (Accessed on 14 September 2019).
- FAO (Food and Agriculture Organization) & WHO (World Health Organization). 2016b. *Codex Alimentarius*. Standard for Cocoa Butter. CXS 86-1981. Food and Agriculture Organization, Rome, Italy. [https://www.fao.org/fao-who-codexalimentarius/sh-proxy/en/?Ink=1&url=https%253A%252F%252Fworkspace.fao.org%252Fsites%252Fcodex%252Fstandards%252FCXS%2B86-1981%252FCXS\\_086e.pdf](https://www.fao.org/fao-who-codexalimentarius/sh-proxy/en/?Ink=1&url=https%253A%252F%252Fworkspace.fao.org%252Fsites%252Fcodex%252Fstandards%252FCXS%2B86-1981%252FCXS_086e.pdf) (Accessed on 25 April 2022)
- FAO (Food and Agriculture Organization) & WHO (World Health Organization). 2016c. *Codex Alimentarius*. Standard for Chocolate and Chocolate Products. STAN 87-1981. Food and Agriculture Organization, Rome, Italy. [https://www.fao.org/fao-who-codexalimentarius/sh-proxy/en/?Ink=1&url=https%253A%252F%252Fworkspace.fao.org%252Fsites%252Fcodex%252Fstandards%252FCXS%2B87-1981%252FCXS\\_087e.pdf](https://www.fao.org/fao-who-codexalimentarius/sh-proxy/en/?Ink=1&url=https%253A%252F%252Fworkspace.fao.org%252Fsites%252Fcodex%252Fstandards%252FCXS%2B87-1981%252FCXS_087e.pdf) (Accessed on 18 July 2018).
- FAO (Food and Agriculture Organization) & WHO (World Health Organization). 2018. *Compendium of Food Additive Specifications* (22 ed.). Joint FAO/WHO Expert Committee on Food Additives, Geneva, Switzerland. 77p.

- FAO (Food and Agriculture Organization) & WHO (World Health Organization). 2020. Codex Alimentarius. General Principles of Food Hygiene. CXC 1-1969. Food and Agriculture Organization, Rome, Italy. <https://www.fao.org/fao-who-codexalimentarius/codex-texts/codes-of-practice/en/> (Accessed on 7 August 2020).
- Farmcomp Oy. 2019. Grain Moisture Meters. <https://www.wile.fi> (Accessed on 3 May 2022).
- FCCI (The Fine Cacao and Chocolate Institute). 2016a. FCCI Cacao Grader Evaluation Version 1.0. [https://chocolateinstitute.org/wp-content/uploads/2017/05/FCCI\\_evaluation\\_english\\_1.0.pdf](https://chocolateinstitute.org/wp-content/uploads/2017/05/FCCI_evaluation_english_1.0.pdf) (Accessed on 3 August 2018).
- FCCI (The Fine Cacao and Chocolate Institute). 2016b. FCCI Cacao Sampling Protocol Version 1.0. [https://chocolateinstitute.org/wp-content/uploads/2017/05/FCCI\\_protocol\\_english\\_1\\_0.pdf](https://chocolateinstitute.org/wp-content/uploads/2017/05/FCCI_protocol_english_1_0.pdf) (Accessed on 17 June 2018).
- Firat. 2018. Polypropilene Sample Container. <http://www.firatmed.com> (Accessed on 3 May 2022).
- France-Etuves. 2020. Des étuves de laboratoires et des étuves industrielles. <https://www.france-etuves.com/> (Accessed on 10 June 2022).
- Frost D J; Adhikari K & Lewis D. 2011. Effect of Barley Flour on the Physical and Sensory Characteristics of Chocolate Chip Cookies. *Journal of Food Science and Technology* 48(5):569-576. doi:10.1007/s13197-010-0179-x
- Gemmy Industrial Corporation. 2022. Hot Air Oven Model YCO-010. <http://www.gemmy.com.tw/>; <http://www.gemmy.com> (Accessed on 2 May 2022).
- Gilson Company Inc. 2018. Materials Testing Equipment. <https://www.globalgilson.com/> (Accessed on 18 July 2018).
- Godshall M; Grimm C; Moore SJ & Batista R. 2003. Comparison of Two Methods of Volatile Analysis for Determining the Causes of Off-Odors in White Beet Sugars - SPME and Headspace. *International Sugar Journal* 105(32):193-208.
- Gourmia. 2022. Gourmia GFD1650 Digital Food Dehydrator. <https://www.gourmia.com> (Accessed on 13 June 2022).
- Greweling PP. 2013. *Chocolates and Confections: Formula, Theory and Technique for the Artisan Confectioner* (2 ed.). John Wiley & Sons, West Sussex, United Kingdom. 544 p.
- Groupe SEB USA. 2022. Fast Touch Electric Coffee and Spice Grinder. <https://www.krupsusa.com> (Accessed on 3 May 2022).
- GSI Outdoors. 2021. GSI Outdoors Java Mill Portable Coffee Grinder. <https://www.gsioutdoors.com> (Accessed on 3 May 2022).
- HAHN+KOLB Werkzeuge GmbH. 2022. Tesamaster A1. <https://www.hahn-kolb.de> (Accessed on 2 May 2022).
- Hanna Instruments Inc. 2022. Digital Thermometer. <https://hannainst.com> (Accessed on 3 May 2022).
- Harvey, D. 2013. Coning and Quartering. Image and Video Exchange Forum. <http://community.asdlib.org/imageandvideoexchangeforum/2013/07/24/coning-and-quartering/> (Accessed on 6 May 2018).
- Harwood ML & Hayes JE. 2017. Sensory Evaluation of Chocolate and Cocoa Products. In: Beckett ST; Fowler MS & Ziegler GR. (eds.), *Beckett's Industrial Chocolate Manufacture and Use*. John Wiley & Sons, West Sussex, United Kingdom. 509-520 p.

- HCP (Heirloom Cacao Preservation Fund). 2018. Protocols for HCP Lab Tests and Raw Bean Characterization Pre-Mass Preparation and Analysis. Fine Chocolate Industry Association. <https://www.hcpcacao.org/hcp-protocols-for-lab-test.html> (Accessed on 24 May 2018).
- Herewegen, N. 2016. Annex 15: Cocoa Bean Manual Puratos Belcolade. In: Sukha D. (ed.), Steps Towards a Harmonized International Standard for Cocoa Flavour Assessment – A Review of Current Protocols and Practices. A technical review presented to the Cocoa of Excellence Programme of Bioversity International and Lutheran World Relief, under Cacao Movil ed., p. 183. The Alliance of Bioversity International and CIAT, Rome, Italy. [https://www.cocoaqualitystandards.org/fileadmin/templates/CocoaQuality/Uploads/Documents-and-reports/REVIEW-Cocoa\\_Quality\\_Flavour\\_Standards\\_-\\_Darin\\_SUKHA\\_sans\\_Appendices-12May2016-ENGLISH.pdf](https://www.cocoaqualitystandards.org/fileadmin/templates/CocoaQuality/Uploads/Documents-and-reports/REVIEW-Cocoa_Quality_Flavour_Standards_-_Darin_SUKHA_sans_Appendices-12May2016-ENGLISH.pdf) (Accessed on 3 May 2022).
- ICE (Intercontinental Exchange Inc). 2017. London Cocoa Futures & Euro Cocoa Futures (Allowances & Discounts - Effective May 2017). [https://www.theice.com/publicdocs/futures/London\\_and\\_Euro\\_Cocoa\\_Futures\\_Effective\\_May\\_2017.pdf](https://www.theice.com/publicdocs/futures/London_and_Euro_Cocoa_Futures_Effective_May_2017.pdf) (Accessed on 17 July 2018).
- InnoVinum LLC. 2022. Is Your Wine Tasting Room Set Up Properly? <https://www.winetasting-demystified.com> (Accessed on 1 May 2022).
- International Trade Centre UNCTAD and WTO. 2001. Cocoa: A Guide to Trade Practices. International Trade Centre, Geneva, Switzerland. 192 p.
- ISO (International Organization for Standardization). 2005. ISO 6658:2005. Sensory Analysis — Methodology — General Guidance. ISO, Geneva, Switzerland. <https://www.iso.org/standard/36226.html> (Accessed on 3 May 2022).
- ISO (International Organization for Standardization). 2007. ISO 8589:2007. Sensory analysis — General Guidance for the Design of Test Rooms. ISO, Geneva, Switzerland. <https://www.iso.org/standard/36385.html> (Accessed on 3 May 2022).
- ISO (International Organization for Standardization). 2008. ISO 5492:2008. Sensory analysis — Vocabulary. ISO, Geneva, Switzerland. <https://www.iso.org/standard/38051.html> (Accessed on 3 May 2022).
- ISO (International Organization for Standardization). 2011. ISO 11037:2011 Sensory Analysis – Guidelines for Sensory Assessment of the Colour of Product. ISO, Geneva, Switzerland. <https://www.iso.org/standard/50112.html> (Accessed on 2 May 2022).
- ISO (International Organization for Standardization). 2012. ISO 8586:2012. Sensory Analysis –General Guidelines for the Selection, Training and Monitoring of Selected Assessors and Expert Sensory Assessors. ISO, Geneva, Switzerland. <https://www.iso.org/standard/45352.html> (Accessed on 2 May 2022).
- ISO (International Organization for Standardization). 2016. ISO 13299:2016. Sensory Analysis – Methodology – General Guidance for Establishing a Sensory Profile. ISO, Geneva, Switzerland. <https://www.iso.org/standard/58042.html> (Accessed on 2 May 2022).
- ISO (International Organization for Standardization). 2016. ISO 3310-1:2016. Test sieves — Technical Requirements and Testing — Part 1: Test Sieves of Metal Wire Cloth. ISO, Geneva, Switzerland. from <https://www.iso.org/standard/62410.html> (Accessed on 27 April 2022).
- ISO (International Organization for Standardization). 2017a. ISO 2292:2017. Cocoa Beans – Sampling. ISO, ISO, Geneva, Switzerland. <https://www.iso.org/standard/68203.html> (Accessed on 27 April 2022).

- ISO (International Organization for Standardization). 2017b. ISO 2451:2017. Cocoa Beans – Specifications and Quality Requirements. ISO, Geneva, Switzerland. <https://www.iso.org/standard/68202.html> (Accessed on 27 April 2022).
- Januszewska R. 2018. Hidden Persuaders in Cocoa and Chocolate: A Flavour Lexicon for Cocoa and Chocolate Sensory Professionals. Woodhead Publishing, Cambridge, United Kingdom. 165 p.
- Jiangsu Zhongxian Group Co Ltd. 2022. Cocoa Butter. <https://zhongxiangoil.en.alibaba.com/> (Accessed on 10 June 2022).
- Kern & Sohn GmbH. 2022. Precision Balance PCB-2000-1. <https://www.sigmaldrich.com> (Accessed on 2 May 2022).
- Khamrui K. 2013. Sensory Evaluation of Functional Fermented Milk Products. Requirements and Tecnique. <https://www.slideshare.net> (Accessed on 1 May 2022).
- King Arthur Baking Company Inc. 2022. Recipies. <https://www.kingarthurflour.com> (Accessed on 10 June 2022).
- KPM Moisture Meters Limited. 2008. Our Meters. <http://www.aqua-boy.co.uk> (Accessed on 15 January 2019).
- Kreslin R; Calvo PM; Galo Corzo L & Peer P. 2014. Linear Chromatic Adaptation Transform Based on Delauney Triangulation. *Mathematical Problems in Engineering* 9(2):1-9 doi:10.1155/2014/760123
- Kring L. 2020. Foodal's Guide to the Best Nutcrackers. <https://foodal.com/kitchen/general-kitchenware/guides-general-kitchenware/foodals-guide-to-the-best-nutcrackers/> (Accessed on 3 May 2022).
- Labotech GmbH. 2022. Hot Plate for Laboratory and Scientific Use. <http://www.labotect.com> (Accessed on 3 May 2022).
- Lacor Menaje. 2012. Chocolate Bain Marie. <http://www.lacor.es> (Accessed on 3 May 2022).
- Laiskonis M. 2018. Post from Michael Laiskonis Instagram Web Page: Pictures of Well-fermented Beans. <https://www.instagram.com/p/BmzEDA9gym-/?taken-by=mlaiskonis> (Accessed on 6 June 2022).
- Lawless HT & Heymann H. 2010. Sensory Evaluation of Food: Principles and Practices (2nd ed.). Springer, New York, USA. 596 p. doi:10.1007/978-1-4419-6488-5
- LG Electronics. 2022. Microwave Ovens. <https://www.lg.com> (Accesed on 3 May 2022).
- Long Island Indicator Service Inc. 2019. 109 – Tesamaster Micrometer With Analogue Digit Counter - Inch or Metric - Made in Switzerland. <http://www.longislandindicator.com> (Accessed on 19 November 2019).
- Luna F; Crouzillat D; Cirou L & Bucheli, P. 2002. Chemical Composition and Flavour of Ecuadorian Cocoa Mass. *Journal of Agricultural and Food Chemistry* 50(12):3527-3532. doi:10.1021/jf0116597
- Mann Lake Bee & Ag Supply. 2022. Gallon Plastic Bucket wit Lid. <https://www.mannlakeltd.com/> (Accessed on 2 May 2022).
- Mastest Spa. 2017. Forced ventilation oven, 220 litres. <https://www.matest.com> (Accessed on 3 May 2022).
- Matest Spa. 2022. Complete Vacuum Desiccator Plate and Desiccant Kit. <http://www.matest.com> (Accessed on 2 May 2022).

- Matfer Bourgeat. 2021. Matfer Bourgeat Coating Spatula for Chocolate. <https://matferbourgeatusa.com/> (Accessed on 3 May 2022).
- McMaster-Carr. 2022. McMaster Steel Wire Catalog. <https://www.mcmaster.com> (Accessed on 2 May 2022).
- McNichols Co. 2022. McNichols Wire Mesh Catalog. <https://www.mcnichols.com> (Accessed on 2 May 2022).
- Metal Mesh. 2022. Glossary. <https://www.metalmesh.com.au/glossary/> (Accessed on 2 May 2022).
- Metal Service Center Institute. 2022. Mesh Type Oven Trays. <https://www.msci.org/> (Accessed on 27 April 2022).
- Mettler Toledo. 2022. Precision Balance MS4002TS/00. <https://www.mt.com> (Accessed on 2 May 2022).
- Misnawi A; Jinap S; Jamilah B & Nazamid S. 2004. Sensory Properties of Cocoa Mass as Affected by Polyphenol Concentration and Duration of Roasting. *Food Quality and Preference* 15(5):403-409. doi:10.1016/S0950-3293(03)00097-1
- Mitutoyo Corporation. 2022. New Products Categories. <https://www.mitutoyo.co.jp/eng/> (Accessed on 2 May 2022).
- MS (Department of Standards Malaysia). 2007. MS 230:2007: Cocoa Beans - Sampling Method for Grading, (First Revision). Department of Standards, Putrajaya, Malaysia. [https://www.koko.gov.my/lkm/industry/sampling\\_method.pdf](https://www.koko.gov.my/lkm/industry/sampling_method.pdf) (Accessed on 31 May 2018).
- Munster GPS. 2022. Digital Infrared Thermometer. <https://www.munstergps.ie/> (Accessed on 10 June 2022).
- Myers ME; Nwozu CV; Whitacre EJ & Hammerstone JF. 2003. United States of America Patent No. 6,582,747 B2. <https://patentimages.storage.googleapis.com/03/12/90/ddc53bc263dbf8/US6582747.pdf> (Accessed on 24 July 2018).
- Naes T; Brockhoff P & Tomic O. 2010. *Statistics for Sensory and Consumer Science*. John Wiley & Sons, West Sussex, United Kingdom. 304 p.
- Neuhaus T. 2006. Doing the cut test. Project Hope and Fairness. Coopaga, Cote d'Ivoire. <http://cocoafarmingpix.blogspot.com/2010/10/cocoa-analysis.html> (Accessed on 10 June 2022).
- Neuhaus, T. 2007. Board Used for Grading Beans. Saf Cacao Testing Laboratory. Project Hope and Fairness. San Pedro, Cote d'Ivoire. <http://cocoafarmingpix.blogspot.com/2010/10/cocoa-analysis.html> (Accessed on 10 June 2022).
- Pascale D. 2006. RGB Coordinates of the Macbeth ColorChecker. The Babel Color Company. [https://babelcolor.com/index\\_htm\\_files/RGB%20Coordinates%20of%20the%20Macbeth%20ColorChecker.pdf](https://babelcolor.com/index_htm_files/RGB%20Coordinates%20of%20the%20Macbeth%20ColorChecker.pdf) (Accessed on 24 July 2018).
- Perfect Choco. 2022. Mini Wheel Tempering. <https://perfectchoco.com> (Accessed on 3 May 2022).
- Pomati Group Srl. 2022. Pomati T5 Chocolate Tempering Machine. <https://www.pomati.it/> (Accessed on 3 May 2022).
- Ravenn India. 2022. Penta Lock Glass 750 ml (4") with Plastic Lid. <https://ravennindia.com/> (Accessed on 10 June 2022).
- Reed S. 2010. Sensory Analysis of Chocolate Mass. *The Manufacturing Confectioner* 90(11):43-52.

- Retsch GmbH. 2022. Mortar Grinder RM 200. <https://www.retsch.com> (Accessed on 2 May 2022).
- Robert Bosch Power Tools GmbH. 2021. Heat Guns. <https://www.bosch-professional.com> (Accessed on 3 May 2022).
- Rooth Chocolate. 2022. Winnowing. <https://rootchocolate.com> (Accessed on 2 May 2022).
- Sampling System Ltd. 2018. Over a Million Stock Items. <https://sampling.com> (Accessed on 19 July 2018).
- Schaller GmbH. 2015. FSA Operating Manual. <https://www.humimeter.com> (Accessed on 3 May 2022).
- Schaller GmbH. 2022. Humimeter FS3 Food Moisture Meter. <https://www.humimeter.com> (Accessed on 3 May 2022).
- Schmidt RH. 2015. Basic Elements of Equipment Cleaning and Sanitizing in Food Processing and Handling Operations. Institute of Food and Agricultural Sciences, University of Florida, FS14, 1-11. from <http://ucfoodsafety.ucdavis.edu/files/26501.pdf> (Accessed on 12 September 2018).
- Seguine, E. 2014. Operating Procedures and Recommendations for Equipment Operation - Laboratory Evaluation of Cocoa Beans, Version 1.0. Cacao Cocoa and Chocolate Advisors, Hanover, Pennsylvania. 30 p.
- Seo Y; Kwak HS; Kim M; Jeong Y & Lee, Y. 2015. Effectiveness of Palate Cleansers on Various Alcoholic Beverages. *Journal of the Institute of Brewing* 121(4):474-480. doi:10.1002/jib.248
- Sigma-Aldrich. 2022. General Catalog. <https://www.sigmaldrich.com> (Accessed on 2 May 2022).
- Smart Sensory Solutions Srl. 2022. The Innovative Software for Sensory and Consumer Tests. <https://www.smartsensorybox.com> (Accessed on 8 June 2022).
- Soehnle Industrial Solutions GmbH. 2022. Soehnle Silvia Retro Style Analogue Kitchen Scale W/Stainless Weighing Bowl. <https://www.soehnle-professional.com/en> (Accessed on 2 May 2022).
- Sonaye SY & Baxi RN. 2012. Particle Size Measurement and Analysis of Flour. *International Journal of Engineering Research and Applications* 2(3):1839-1842. from <https://pdfs.semanticscholar.org/733d/2329d88d08ea3a41070894fc5c558efd11c7.pdf> (Accessed on 7 September 2018).
- Spectra Plaza. 2022. Spectra Melangers. <https://www.spectramelangers.com> (Accessed on 2 May 2022).
- Stanley Black & Decker. 2022. Snap-off Knives. <https://www.stanleytools.com> (Accessed on 3 May 2022).
- Stefanelli EJ. 2022. Micrómetro virtual – Simulador en Milésimas de Milímetro. [www.stefanelli.eng.br](http://www.stefanelli.eng.br): <https://www.stefanelli.eng.br/es> (Accessed on 2 May 2022).
- Stone H & Sidel JL. 2004. *Sensory Evaluation Practices* (3 ed.). Elsevier Academic Press, San Diego, USA. 326 p.
- Sukha D. 2016. Elements of a Harmonized International Standard for Cocoa Flavour Assessment. A Proposal for Further Consultation. Third Annual Seminar on Cocoa in the Americas, 5-7 September, 2016 pp. 23-25. Sonesta Hotel, Guayaquil, Ecuador. <https://www.cocoaqualitystandards.org/fileadmin/templates/CocoaQuality/Uploads/Documents-and-reports/WG-Quality-Flavour-Standards-ENGLISH-11Set2017.pdf> (Accessed on 4 May 2022).
- Sukha D & Ali NA. 2016. *Standard Operating Procedures for Cocoa Mass Production*. University of the West Indies, Trinidad Food Technology Section of the Cocoa Research Centre, St. Augustine, Trinidad and Tobago. 31 p.

- Sukha, D., & Ali, N. A. 2017. Analysing Sensory and Processing Quality of Cocoa. In: Umaharan P. (ed.), *Achieving Sustainable Cultivation of Cocoa: Genetics, Breeding, Cultivation and Quality*, Vol. I. Burleigh Dodds Science Publishing, Cambridge, United Kingdom. pp. 395-442.
- Sukha D & Rohsius C. 2004. Cocoa Cut Test Chart. Technical Guide. The University of Hamburg, Centre Klein Flottbek, The University of the West Indies, Cocoa Research Center, Hamburg and St. Augustine. 6 p.
- Sukha D; Butler D R; Umaharan P & Boulton E. 2008. The Use of an Optimised Organoleptic Assessment Protocol to Describe and Quantify Different Flavour Attributes of Cocoa Masses Made from Ghana and Trinitario Beans. *European Food Research and Technology* 226(3):405-413.
- Tasty Type Blog. 2008. Chocolate Pandan Ice Cream. <http://tastytype.blogspot.com> (Accessed on 3 May 2022).
- Taylor, G. 2018. Quality Certification for Dry Cocoa Beans. <https://docplayer.net/49925052-Quality-certification-for-dry-cocoa-beans.html> (Accessed on 2 May 2022).
- Tesa Technology. 2022. Tesa Products. <https://tesatechnology.com/> (Accessed on 10 June 2022).
- Teserba GmbH. 2022. The Magra Dried Fruit Cutting Units. <http://www.teserba.ch> (Accessed on 2 May 2022).
- The Champion Juicer. 2022. Classic 2000 Household Black. <https://championjuicer.com> (Accessed on 2 May 2022).
- The Grenada Chocolate Company. 2018. Refining and Conching. <https://www.grenadachocolate.com> (Accessed on 28 July 2018).
- The Lab in the Bag. 2017. Aluminium Sensory Analysis Booths. <https://thelabinthebag.com> (Accessed on 1 May 2022).
- Thermo Fisher Scientific Inc. 2022. Precision Water Baths User Manual. <https://www.fishersci.es> (Accessed on 3 May 2022).
- Thomas Scientific LLC. 2022. Scientific Supplies. <https://www.thomassci.com> (Accessed on 2 May 2022).
- TTBS (Trinidad and Tobago Bureau of Standards). 2019. TTS 646:2019. Cocoa Beans – Sampling (ISO 2292:2017, MOD). Trinidad and Tobago Standard., Macoya, Trinidad and Tobago.
- US FDA (United States Food and Drug Administration). 2017. MPM: V-4. Chocolate, Sugars, and Related Products. Silver Spring, USA. <https://www.fda.gov/food/laboratory-methods-food/mpm-v-4-chocolate-sugars-and-related-products> (Accessed on 25 July 2018).
- USAID (United States Agency for International Development); EE (Equal Exchange) & TCHO (TechCHOocolate) Cooperative Development Programme. 2018. Guide to the Cacao Sensory Analysis Tasting Form. USAID-Equal Exchange-TCHO Cooperative Development Project. [https://equalexchange.coop/sites/default/files/Tasting-Guide\\_vF-JUNE2018.pdf](https://equalexchange.coop/sites/default/files/Tasting-Guide_vF-JUNE2018.pdf) (Accessed on 24 September 2018).
- Vegan Baking Recipe. 2022. How To Make and Use a Double Boiler or Bain Marie. from <http://www.veganbaking.net/>: <http://www.veganbaking.net> (Accessed on 3 May 2022).
- Velmourougane K; Gopinandhan T & Bhat R. 2014. Application of Hazard Analysis and Critical Control Point Principles for Ochratoxin-A Prevention in Coffee Production Chain. In: Bhat R & Gómez-López VM. (eds.), *Practical Food Safety: Contemporary Issues and Future Directions*. John Wiley & Sons Ltd, Oxford, United Kingdom. pp. 577–595.

- Vila Ayala J; Calliau G; Foubert I; Dewettinck K; Dyer B & De Greyt W. 2007. Impacts of Bleaching and Packed Column Steam Refining on Cocoa Butter Properties. *Journal of the American Oil Chemists' Society* 84(11):1069-1077.
- VWR International LLC. 2022. Dry block heater, Advanced, Digital, with Heated Lid. <https://uk.vwr.com> (Accessed on 3 May 2022).
- Walfos Factory. 2021. Thermoresistant Flexible Spatula. <https://www.simplyhealthyfamily.org> (Accessed on 3 May 2022).
- West Bend. 2022. Air Crazy Popcorn Machine. <https://westbend.com> (Accessed on 2 May 2022).
- WHO (World Health Organization). 2006. How to Handrub? / How to Handwash? Standard World Health Organization procedures of alcohol-based handrub and handwash with soap and water. <https://www.who.int/gpsc/tools/GPSC-HandRub-Wash.pdf> (Accessed on 2 May 2022).
- Wilton Brands LLC. 2003. Tools. <https://www.wilton.com/> (Accessed on 10 June 2022).
- Worth Point Corporation. 2022. Old Winnowing Sifter Basket. Maidu Mono Calif Indian. <https://www.worthpoint.com> (Accessed on 2 May 2022).
- Żyżelewicz D; Budryn G; Oracz J; Antolak H; Kręgiel D & Kaczmarska M. 2018. The Effect on Bioactive Components and Characteristics of Chocolate by Functionalization with Raw Cocoa Beans. *Food Research International* 113:234-244. doi:10.1016/j.foodres.2018.07.017



# Empowering a new generation of cacao producers of excellence





**mocca**

Maximizing Opportunities  
in Coffee and Cacao in the Americas

